

# USB-1208LS

USB-based Analog and Digital I/O Module

## User's Guide



# USB-1208LS

## USB-based Analog and Digital I/O Module

### User's Guide



**MEASUREMENT  
COMPUTING™**

Document Revision 2, May, 2006

© Copyright 2006, Measurement Computing Corporation

Your new Measurement Computing product comes with a fantastic extra —

## Management committed to your satisfaction!

Refer to [www.mccdaq.com/execteam.html](http://www.mccdaq.com/execteam.html) for the names, titles, and contact information of each key executive at Measurement Computing.

Thank you for choosing a Measurement Computing product—and congratulations! You own the finest, and you can now enjoy the protection of the most comprehensive warranties and unmatched phone tech support. It's the embodiment of our two missions:

- To offer the highest-quality, computer-based data acquisition, control, and GPIB hardware and software available—at the best possible price.
- To offer our customers superior post-sale support—FREE. Whether providing unrivaled telephone technical and sales support on our latest product offerings, or continuing that same first-rate support on older products and operating systems, we're committed to you!

**Lifetime warranty:** Every hardware product manufactured by Measurement Computing Corporation is warranted against defects in materials or workmanship for the life of the product. Products found defective are repaired or replaced promptly.

**Lifetime Harsh Environment Warranty®:** We will replace any product manufactured by Measurement Computing Corporation that is damaged (even due to misuse) for only 50% of the current list price. I/O boards face some tough operating conditions—some more severe than the boards are designed to withstand. When a board becomes damaged, just return the unit with an order for its replacement at only 50% of the current list price. We don't need to profit from your misfortune. By the way, we honor this warranty for any manufacturer's board that we have a replacement for.

**30 Day Money Back Guarantee:** You may return any Measurement Computing Corporation product within 30 days of purchase for a full refund of the price paid for the product being returned. If you are not satisfied, or chose the wrong product by mistake, you do not have to keep it. Please call for an RMA number first. No credits or returns accepted without a copy of the original invoice. Some software products are subject to a repackaging fee.

*These warranties are in lieu of all other warranties, expressed or implied, including any implied warranty of merchantability or fitness for a particular application. The remedies provided herein are the buyer's sole and exclusive remedies. Neither Measurement Computing Corporation, nor its employees shall be liable for any direct or indirect, special, incidental or consequential damage arising from the use of its products, even if Measurement Computing Corporation has been notified in advance of the possibility of such damages.*

### **Trademark and Copyright Information**

TracerDAQ, Universal Library, *InstaCal*, Harsh Environment Warranty, Measurement Computing Corporation, and the Measurement Computing logo are either trademarks or registered trademarks of Measurement Computing Corporation.

Windows, Microsoft, and Visual Studio are either trademarks or registered trademarks of Microsoft Corporation

LabVIEW is a trademark of National Instruments.

CompactFlash is a registered trademark of SanDisk Corporation.

All other trademarks are the property of their respective owners.

Information furnished by Measurement Computing Corporation is believed to be accurate and reliable. However, no responsibility is assumed by Measurement Computing Corporation neither for its use; nor for any infringements of patents or other rights of third parties, which may result from its use. No license is granted by implication or otherwise under any patent or copyrights of Measurement Computing Corporation.

All rights reserved. No part of this publication may be reproduced, stored in a retrieval system, or transmitted, in any form by any means, electronic, mechanical, by photocopying, recording, or otherwise without the prior written permission of Measurement Computing Corporation.

#### **Notice**

Measurement Computing Corporation does not authorize any Measurement Computing Corporation product for use in life support systems and/or devices without prior written consent from Measurement Computing Corporation. Life support devices/systems are devices or systems which, a) are intended for surgical implantation into the body, or b) support or sustain life and whose failure to perform can be reasonably expected to result in injury. Measurement Computing Corporation products are not designed with the components required, and are not subject to the testing required to ensure a level of reliability suitable for the treatment and diagnosis of people.

---

# Table of Contents

## Preface

<b>About this User's Guide .....</b>	<b>vi</b>
What you will learn from this user's guide .....	vi
Conventions in this user's guide .....	vi
Where to find more information .....	vi

## Chapter 1

<b>Introducing the USB-1208LS.....</b>	<b>1-1</b>
USB-1208LS block diagram.....	1-2
Software features .....	1-2
Connecting a USB-1208LS to your computer is easy .....	1-3

## Chapter 2

<b>Installing the USB-1208LS.....</b>	<b>2-1</b>
What comes with your USB-1208LS shipment? .....	2-1
Hardware .....	2-1
Additional documentation.....	2-1
Unpacking the USB-1208LS .....	2-1
Installing the software .....	2-2
Installing the hardware .....	2-2

## Chapter 3

<b>Functional Details .....</b>	<b>3-1</b>
Theory of operation - analog input acquisition modes .....	3-1
Software paced mode.....	3-1
Continuous scan mode .....	3-1
Burst scan mode.....	3-1
External components .....	3-2
USB connector.....	3-2
LED .....	3-2
Screw terminal wiring.....	3-3
Main connector and pin out .....	3-3
Analog input terminals (CH0 IN - CH7 IN).....	3-4
Digital I/O terminals (Port A0 to A7, and Port B0 to B7).....	3-7
Power terminals .....	3-8
Ground terminals .....	3-8
Calibration terminal .....	3-9
Trigger terminal .....	3-9
Counter terminal .....	3-9
Accuracy.....	3-9
USB-1208LS channel gain queue feature.....	3-12

## Chapter 4

<b>Specifications .....</b>	<b>4-1</b>
Analog output .....	4-2
Digital input/output.....	4-3
External trigger .....	4-3
Counter .....	4-3
Non-volatile memory.....	4-3
Power.....	4-4
General .....	4-4
Environmental .....	4-4

Mechanical .....	4-4
Main connector and pin out .....	4-4
4-channel differential mode .....	4-5
8-channel single-ended mode.....	4-5

---

## About this User's Guide

### What you will learn from this user's guide

This user's guide explains how to install, configure, and use the USB-1208LS so that you get the most out of its USB data acquisition features.

This user's guide also refers you to related documents available on our web site, and to technical support resources that can also help you get the most out of the USB-1208LS.

### Conventions in this user's guide

**For more information on ...**

Text presented in a box signifies additional information and helpful hints related to the subject matter you are reading.

**Caution!** Shaded caution statements present information to help you avoid injuring yourself and others, damaging your hardware, or losing your data.

<#:#> Angle brackets that enclose numbers separated by a colon signify a range of numbers, such as those assigned to registers, bit settings, etc.

**bold text** **Bold** text is used for the names of objects on the screen, such as buttons, text boxes, and check boxes. For example:

1. Insert the disk or CD and click the **OK** button.

*italic text* *Italic* text is used for the names of manuals and help topic titles, and to emphasize a word or phrase. For example:

The *InstaCal*® installation procedure is explained in the *Quick Start Guide*.  
*Never* touch the exposed pins or circuit connections on the board.

### Where to find more information

The following electronic documents provide helpful information relevant to the operation of the USB-1208LS

- MCC's *Specifications: USB-1208LS* (the PDF version of the Electrical Specification Chapter in this guide) is available on our web site at [www.mccdaq.com/pdfs/USB-1208LS.pdf](http://www.mccdaq.com/pdfs/USB-1208LS.pdf).
- MCC's *Quick Start Guide* is available on our web site at [www.mccdaq.com/PDFmanuals/DAQ-Software-Quick-Start.pdf](http://www.mccdaq.com/PDFmanuals/DAQ-Software-Quick-Start.pdf).
- MCC's *Guide to Signal Connections* is available on our web site at [www.mccdaq.com/signals/signals.pdf](http://www.mccdaq.com/signals/signals.pdf).
- MCC's *Universal Library User's Guide* is available on our web site at [www.mccdaq.com/PDFmanuals/sm-ul-user-guide.pdf](http://www.mccdaq.com/PDFmanuals/sm-ul-user-guide.pdf).
- MCC's *Universal Library Function Reference* is available on our web site at [www.mccdaq.com/PDFmanuals/sm-ul-functions.pdf](http://www.mccdaq.com/PDFmanuals/sm-ul-functions.pdf).
- MCC's *Universal Library for LabVIEW™ User's Guide* is available on our web site at [www.mccdaq.com/PDFmanuals/SM-UL-LabVIEW.pdf](http://www.mccdaq.com/PDFmanuals/SM-UL-LabVIEW.pdf).

*USB-1208LS User's Guide* (this document) is also available on our web site at [www.mccdaq.com/PDFmanuals/USB-1208LS.pdf](http://www.mccdaq.com/PDFmanuals/USB-1208LS.pdf).

---

## Introducing the USB-1208LS

This user's guide contains all of the information you need to connect the USB-1208LS to your computer and to the signals you want to measure.

The USB-1208LS is a USB 1.1 low-speed device supported under popular Microsoft® Windows® operating systems. It is designed for USB 1.1 ports, and was tested for full compatibility with both USB 1.1 and USB 2.0 ports.

The USB-1208LS features eight analog inputs, two 10-bit analog outputs, 16 digital I/O connections, and one 32-bit external event counter. The USB-1208LS is powered by the +5 volt USB supply from your computer. No external power is required.

The USB-1208LS analog inputs are software configurable for either eight 11-bit single-ended inputs, or four 12-bit differential inputs. An on-board industry standard 82C55 programmable peripheral interface chip provides the 16 digital I/O lines in two 8-bit ports. You can configure each digital port independently for either input or output.

The USB-1208LS is shown in Figure 1-1. I/O connections are made to the screw terminals located along each side of the USB-1208LS.



Figure 1-1. USB-1208LS



## USB-1208LS block diagram

USB-1208LS functions are illustrated in the block diagram shown here.

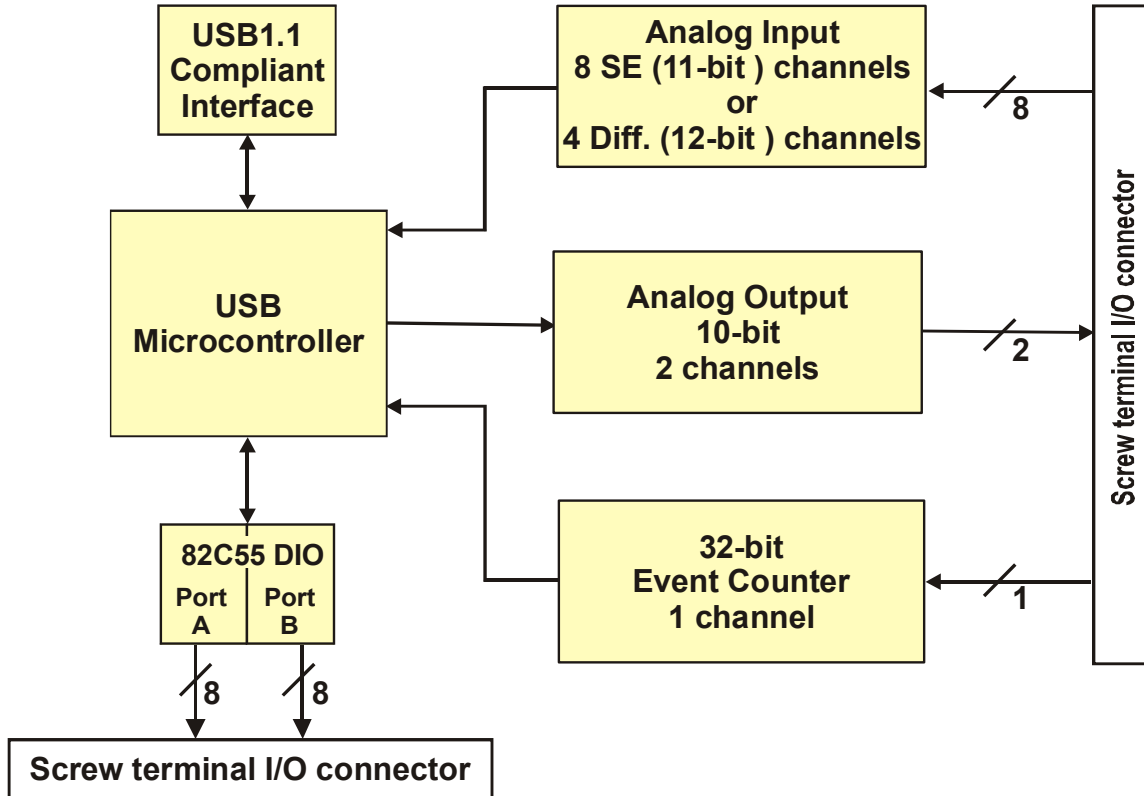

Figure 1-2. USB-1208LS Functional block diagram

## Software features

For information on the features of *InstaCal* and the other software included with your USB-1208LS, refer to the *Quick Start Guide* that shipped with your device. The *Quick Start Guide* is also available in PDF at [www.mccdaq.com/PDFmanuals/DAQ-Software-Quick-Start.pdf](http://www.mccdaq.com/PDFmanuals/DAQ-Software-Quick-Start.pdf).

Check [www.mccdaq.com/download.htm](http://www.mccdaq.com/download.htm) for the latest software version or versions of the software supported under less commonly used operating systems.

## Connecting a USB-1208LS to your computer is easy

Installing a data acquisition device has never been easier.

- The USB-1208LS relies upon the Microsoft Human Interface Device (HID) class drivers. The HID class drivers ship with every copy of Windows that is designed to work with USB ports. We use the Microsoft HID because it is a standard, and its performance delivers full control and maximizes data transfer rates for your USB-1208LS. No third-party device driver is required.
- The USB-1208LS is plug-and-play. There are no jumpers to position, DIP switches to set, or interrupts to configure.
- You can connect the USB-1208LS before or after you install the software, and without powering down your computer first. When you connect an HID to your system, your computer automatically detects it and configures the necessary software. You can connect and power multiple HID peripherals to your system using a USB hub.
- You can connect your system to various devices using a standard four-wire cable. The USB connector replaces the serial and parallel port connectors with one standardized plug and port combination.
- You do not need a separate power supply module. The USB automatically delivers the electrical power required by each peripheral connected to your system.
- Data can flow two ways between a computer and peripheral over USB connections.

---

## Installing the USB-1208LS

### What comes with your USB-1208LS shipment?

As you unpack your USB-1208LS, verify that the following components are included.

#### Hardware

- USB-1208LS



- USB cable (2 meter length)



#### Additional documentation

In addition to this hardware user's guide, you should also receive the *Quick Start Guide* (available in PDF at [www.mccdaq.com/PDFmanuals/DAQ-Software-Quick-Start.pdf](http://www.mccdaq.com/PDFmanuals/DAQ-Software-Quick-Start.pdf)). This booklet supplies a brief description of the software you received with your USB-1208LS and information regarding installation of that software. Please read this booklet completely before installing any software or hardware.

### Unpacking the USB-1208LS

As with any electronic device, you should take care while handling to avoid damage from static electricity. Before removing the USB-1208LS from its packaging, ground yourself using a wrist strap or by simply touching the computer chassis or other grounded object to eliminate any stored static charge.

If any components are missing or damaged, notify Measurement Computing Corporation immediately by phone, fax, or e-mail:

- Phone: 508-946-5100 and follow the instructions for reaching Tech Support.
- Fax: 508-946-9500 to the attention of Tech Support
- Email: [techsupport@mccdaq.com](mailto:techsupport@mccdaq.com)

## Installing the software

Refer to the *Quick Start Guide* for instructions on installing the software on the *Measurement Computing Data Acquisition Software CD*. This booklet is available in PDF at [www.mccdaq.com/PDFmanuals/DAQ-Software-Quick-Start.pdf](http://www.mccdaq.com/PDFmanuals/DAQ-Software-Quick-Start.pdf).

## Installing the hardware

### Be sure you are using the latest system software

Before you connect the USB-1208LS, make sure that you are using the latest versions of the USB drivers.

Before installing the USB-1208LS, download and install the latest Microsoft Windows updates. In particular, when using Windows XP, make sure you have XP Hotfix KB822603 installed. This update is intended to address a serious error in Usbport.sys when you operate a USB device. You can run Windows Update or download the update from [www.microsoft.com/downloads/details.aspx?familyid=733dd867-56a0-4956-b7fe-e85b688b7f86&displaylang=en](http://www.microsoft.com/downloads/details.aspx?familyid=733dd867-56a0-4956-b7fe-e85b688b7f86&displaylang=en). For more information, refer to the Microsoft Knowledge Base article "Availability of the Windows XP SP1 USB 1.1 and 2.0 update." This article is available at [support.microsoft.com/?kbid=822603](http://support.microsoft.com/?kbid=822603).

To connect the USB-1208LS to your system, turn your computer on, and connect the USB cable to a USB port on your computer or to an external USB hub that is connected to your computer. The USB cable provides power and communication to the USB-1208LS.

When you connect the USB-1208LS for the first time, a **Found New Hardware** popup balloon (Windows XP) or dialog (other Windows versions) opens as the USB-1208LS is detected by your computer.

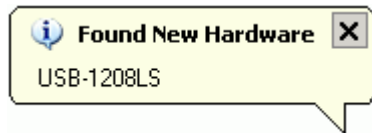

Another **Found New Hardware** balloon or dialog opens after the first closes that identifies the USB-1208LS as a USB Human Interface Device.

When this balloon or dialog closes, the installation is complete. The LED on the USB-1208LS should flash and then remain lit. This indicates that communication is established between the USB-1208LS and your computer.

**Caution!** Do not disconnect **any** device from the USB bus while the computer is communicating with the USB-1208LS, or you may lose data and/or your ability to communicate with the USB-1208LS.

### If the LED turns off

If the LED is illuminated but then turns off, the computer has lost communication with the USB-1208LS. To restore communication, disconnect the USB cable from the computer, and then reconnect it. This should restore communication, and the LED should turn back *on*.

---

## Functional Details

### Theory of operation - analog input acquisition modes

The USB-1208LS can acquire analog input data in three different modes – software paced, continuous scan, and burst scan.

#### Software paced mode

In software paced mode, you can acquire one analog sample at a time. You initiate the A/D conversion by calling a software command. The analog value is converted to digital and returned to the computer. You can repeat this procedure until you have the total number of samples that you want from one channel.

Software pacing is limited by the 20 mS round-trip requirement of a USB interrupt-type endpoint operation. The maximum throughput sample rate in software paced mode is 50 S/s.

#### Continuous scan mode

In continuous scan mode, you can acquire data from up to eight channels. The analog data is continuously acquired, converted to digital values, and written to an on-board FIFO buffer until you stop the scan. The FIFO buffer is serviced in blocks as the data is transferred from the USB-1208LS to the memory buffer on your computer.

The maximum continuous scan rate of 1.2 kS/s is an aggregate rate. The total acquisition rate for all channels cannot exceed 1.2 kS/s. You can acquire data from one channel at 1.2 kS/s, two channels at 600 S/s and four channels at 300 S/s. You can start a continuous scan with either a software command or with an external hardware trigger event.

#### Burst scan mode

In burst scan mode, you can acquire data using the full capacity of the USB-1208LS 4 k sample FIFO. You can initiate a single acquisition sequence of up to 4096 samples channels by either a software command or an external hardware trigger. The captured data is then read from the FIFO and transferred to a user buffer in the host PC.

Burst scans are limited to the depth of the on-board memory, as the data is acquired at a rate faster than it can be transferred to the computer. The maximum sampling rate is an aggregate rate. The maximum rates that you can acquire data using burst scan mode is 8 kS/s divided by the number of channels in the scan.

## External components

The USB-1208LS has the following external components, as shown in Figure 3-1.

- USB connector
- LED
- Screw terminal banks (2)

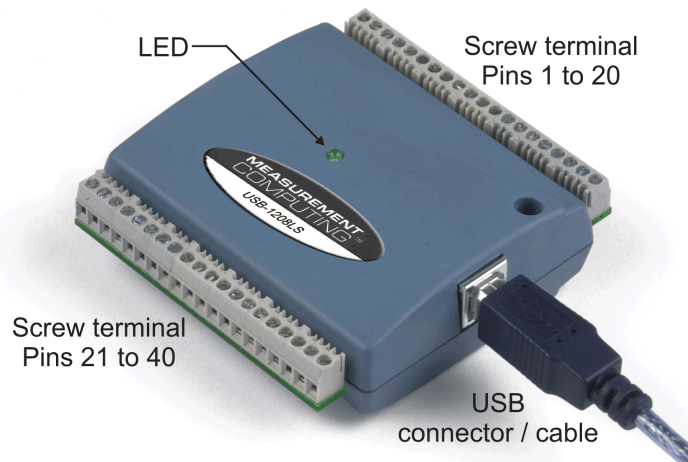

Figure 3-1. USB-1208LS external components

### USB connector

The USB connector is on the right side of the USB-1208LS housing. This connector provides +5V power and communication. The voltage supplied through the USB connector is system-dependent, and may be less than 5V. No external power supply is required.

### LED

The LED on the front of the housing indicates the communication status of the USB-1208LS. It uses up to 5 mA of current and cannot be disabled. Table 3-1 defines the function of the USB-1208LS LED.

Table 3-1. LED illumination

When the LED is...	It indicates...
Steady green	The USB-1208LS is connected to a computer or external USB hub.
Blinks continuously	Data is being transferred.
Blinks three times	Initial communication is established between the USB-1208LS and the computer.
Blinks at a slow rate	The analog input is configured for external trigger. The LED stops blinking and illuminates steady green when the trigger is received.

## Screw terminal wiring

The USB-1208LS has two rows of screw terminals—one row on the top edge of the housing, and one row on the bottom edge. Each row has 20 connections. Pin numbers are identified in Figure 3-2.

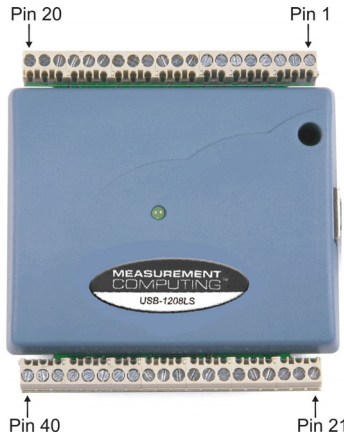

Figure 3-2. USB-1208LS Screw terminal pin numbers

### Screw terminal – pins 1-20

The screw terminals on the top edge of the USB-1208LS (pins 1 to 20) provide the following connections:

- Eight analog input connections (**CH0 IN** to **CH7 IN**)
- Two analog output connections (**D/A OUT 0** to **D/A OUT 1**)
- One external trigger source (**TRIG\_IN**)
- One external event counter connection (**CTR**)
- Seven GND connections (**GND**)
- One calibration terminal (**CAL**)

### Screw terminal – pins 21-40

The screw terminals on the bottom edge of the (pins 21 to 40) provide the following connections:

- 16 digital I/O connections (**PortA0** to **Port A7**, and **Port B0** to **Port B7**)
- One power connection (**PC+5 V**)
- Three ground connections (**GND**)

### Main connector and pin out

Connector type	Screw terminal
Wire gauge range	16 AWG to 30 AWG

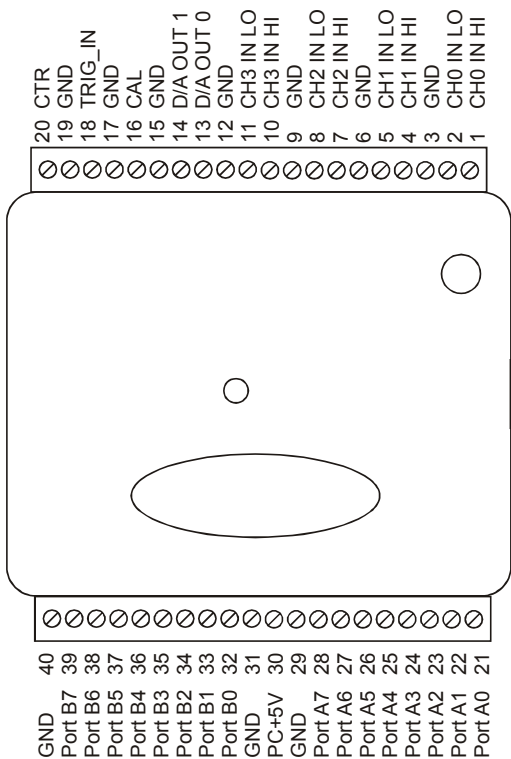

4-channel differential mode pin out

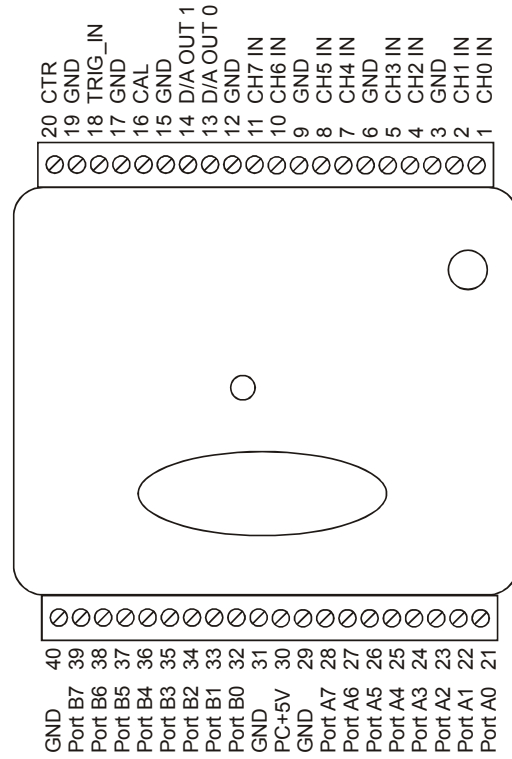

8-channel single-ended mode pin out

### Analog input terminals (CH0 IN - CH7 IN)

You can connect up to eight analog input connections to the screw terminal containing pins 1 to 20 (**CH0 IN** through **CH7 IN**). Refer to the [pinout diagrams](#) on page 3-4 for the location of these pins.

You can configure the analog input channels as eight single-ended channels or four differential channels. When configured for differential mode, each analog input has 12-bit resolution. When configured for single-ended mode, each analog input has 11-bit resolution, due to restrictions imposed by the A/D converter.

#### Single-ended configuration

When all of the analog input channels are configured for single-ended input mode, eight analog channels are available. The input signal is referenced to signal ground (GND), and delivered through two wires:

- The wire carrying the signal to be measured connects to CH# IN.
- The second wire connects to GND.

The input range for single-ended mode is  $\pm 10V$ . No other ranges are supported in single-ended mode. Figure 3-3 illustrates a typical single-ended measurement connection.



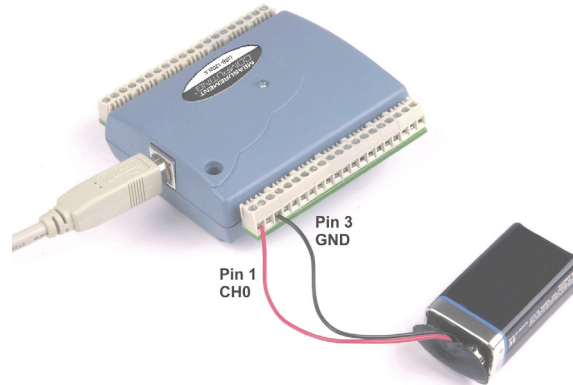

Figure 3-3. Single-ended measurement connection

The following image shows the single-ended measurement data acquired by TracerDAQ.

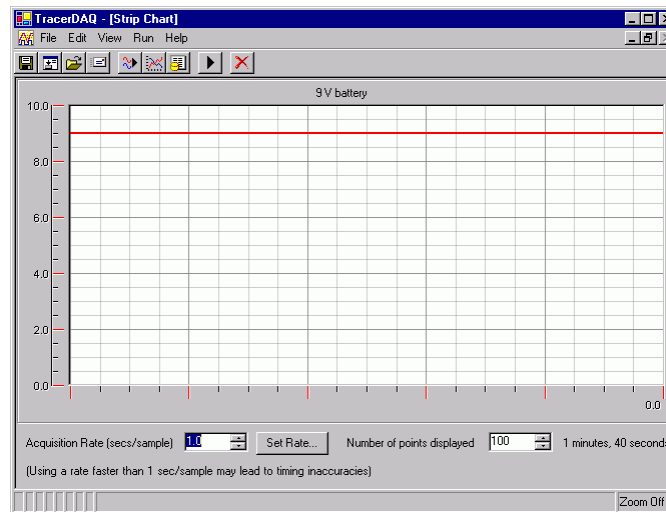

Figure 3-4. TracerDAQ plot of single-ended measurement data

### Single-ended measurements using differential channels

To perform a single-ended measurement using differential channels, connect the signal to "CH $n$  IN HI" input, and ground the associated "CH $n$  IN LO" input.

### Differential configuration

When all of the analog input channels are configured for differential input mode, four analog channels are available. In differential mode, the input signal is measured with respect to the low input.

The input signal is delivered through three wires:

- The wire carrying the signal to be measured connects to CH0 IN HI, CH1 IN HI, CH2 IN HI, or CH3 IN HI.
- The wire carrying the reference signal connects to CH0 IN LO, CH1 IN LO, CH2 IN LO, or CH3 IN LO.
- The third wire connects to GND.

A low-noise precision programmable gain amplifier (PGA) is available on differential channels to provide gains of up to 20 and a dynamic range of up to 12-bits. Differential mode input voltage ranges are  $\pm 20$  V,  $\pm 10$  V,  $\pm 5$  V,  $\pm 4$  V,  $\pm 2.5$  V,  $\pm 2.0$  V, 1.25 V, and  $\pm 1.0$  V.

In differential mode, the following two requirements must be met for linear operation:

- Any analog input must remain in the  $-10\text{V}$  to  $+20\text{V}$  range with respect to ground at all times.
- The maximum differential voltage on any given analog input pair must remain within the selected voltage range.

The input [*common-mode voltage + signal*] of the differential channel must be in the  $-10\text{V}$  to  $+20\text{V}$  range in order to yield a useful result. For example, you input a  $4\text{V}$  pp sine wave to CHHI, and apply the same sine wave  $180^\circ$  out of phase to CHLO. The common mode voltage is  $0\text{V}$ . The differential input voltage swings from  $4\text{V} - (-4\text{V}) = 8\text{V}$  to  $-4\text{V} - 4\text{V} = -8\text{V}$ . Both inputs satisfy the  $-10\text{V}$  to  $+20\text{V}$  input range requirement, and the differential voltage is suited for the  $\pm 10\text{V}$  input range (see Figure 3-5).

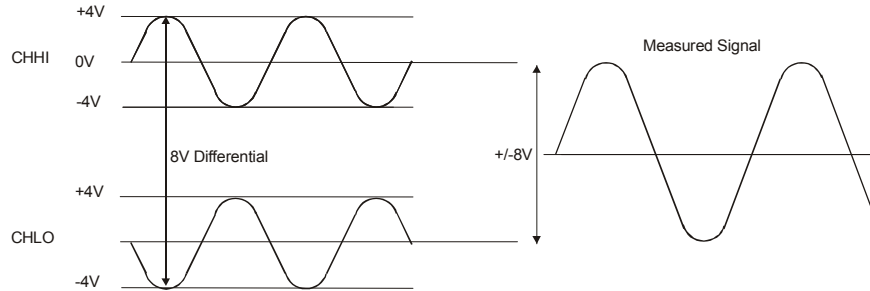

Figure 3-5. Differential voltage example: common mode voltage of  $0\text{V}$

If you increase the common mode voltage to  $11\text{V}$ , the differential remains at  $\pm 8\text{V}$ . Although the [*common-mode voltage + signal*] on each input now has a range of  $+7\text{V}$  to  $+15\text{V}$ , both inputs still satisfy the  $-10\text{V}$  to  $+20\text{V}$  input requirement (see Figure 3-6).

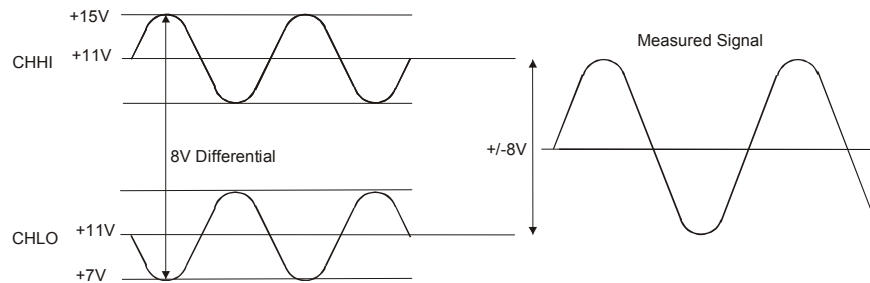

Figure 3-6. Differential voltage example: common mode voltage of  $11\text{V}$

If you decrease the common-mode voltage to  $-7\text{V}$ , the differential stays at  $\pm 8\text{V}$ . However, the solution now violates the input range condition of  $-10\text{V}$  to  $+20\text{V}$ . The voltage on each analog input now swings from  $-3\text{V}$  to  $-11\text{V}$ . Voltages between  $-10\text{V}$  and  $-3\text{V}$  are resolved, but those below  $-10\text{V}$  are clipped (see Figure 3-7).

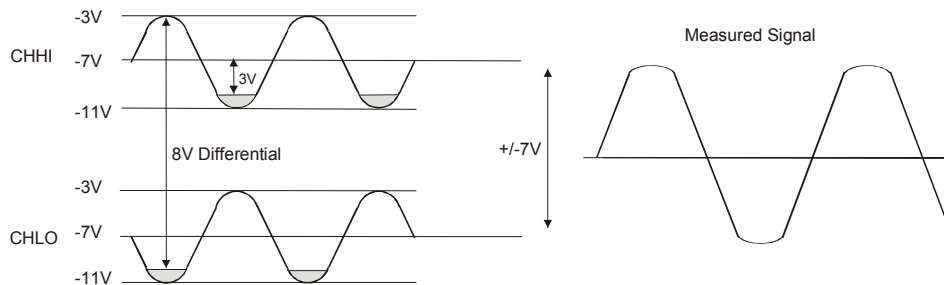

Figure 3-7. Differential voltage example: common mode voltage of  $-7\text{V}$

Since the analog inputs are restricted to a  $-10\text{ V}$  to  $+20\text{ V}$  signal swing with respect to ground, all ranges *except*  $\pm 20\text{ V}$  can realize a linear output for any differential signal with zero common mode voltage and full scale signal inputs. The  $\pm 20\text{ V}$  range is the exception. You cannot put  $-20\text{ V}$  on CHHI and  $0\text{ V}$  on CHLO since this violates the input range criteria.

Table 3-2 shows some possible inputs and the expected results.

Table 3-2. Sample inputs and differential results

CHHI	CHLO	Result
-20 V	0 V	Invalid
-15 V	+5 V	Invalid
-10 V	0 V	-10 V
-10 V	+10 V	-20 V
0 V	+10 V	-10 V
0 V	+20 V	-20 V
+10 V	-10 V	+20 V
+10 V	0 V	+10 V
+15 V	-5 V	+20 V
+20 V	0	+20 V

**For more information on analog signal connections**

For more information on single-ended and differential inputs, refer to the *Guide to Signal Connections* (this document is available on our web site at [www.mccdaq.com/signals/signals.pdf](http://www.mccdaq.com/signals/signals.pdf))

**Digital I/O terminals (Port A0 to A7, and Port B0 to B7)**

You can connect up to 16 digital I/O lines to the screw terminal containing pins 21 to 40 (**Port A0 to Port A7**, and **Port B0 to Port B7**.) Refer to the [pinout diagrams](#) on page 3-4 for the location of these pins. You can configure each digital port for either input or output.

When you configure the digital bits for input, you can use the digital I/O terminals to detect the state of any TTL level input. Refer to the switch shown in Figure 3-8 and the schematic shown in Figure 3-9. If the switch is set to the  $+5\text{ V}$  input, Port A0 reads *TRUE* (1). If you move the switch to GND, Port A0 reads *FALSE*.

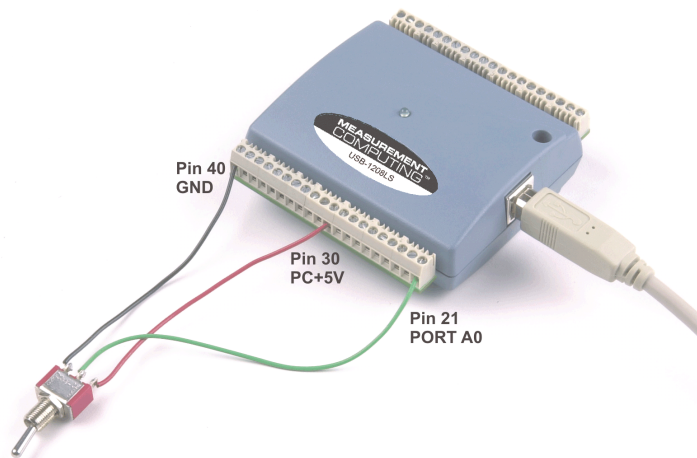

Figure 3-8. Digital connection Port A0 detecting the state of a switch

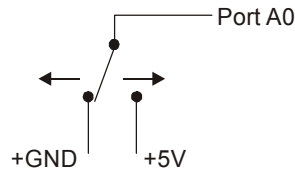

Figure 3-9. Schematic showing switch detection by digital channel Port A0

#### For more information on digital signal connections

For more information on digital signal connections and digital I/O techniques, refer to the *Guide to Signal Connections* (available on our web site at [www.mccdaq.com/signals/signals.pdf](http://www.mccdaq.com/signals/signals.pdf)).

## Power terminals

The **PC +5 V** connection (pin 30) is on the bottom screw terminal of the USB-1208LS. Refer to the [pinout diagrams](#) on page 3-4 for the location of this pin. This terminal draws power from the USB connector. The +5 V screw terminal is a 5 volt output that is supplied by the host computer.

**Caution!** The +5V terminal is an output. Do not connect to an external power supply or you may damage the USB-1208LS and possibly the computer.

The maximum total output current that can be drawn from all USB-1208LS connections (power, analog and digital outputs) is 500 mA. This maximum applies to most personal computers and self-powered USB hubs. Bus-powered hubs and notebook computers may limit the maximum available output current to 100 mA.

Just connecting the USB-1208LS to your computer draws 20 mA of current from the USB +5 V supply. Once you start running applications with the USB-1208LS, each DIO bit can draw up to 2.5 mA, and each analog output can draw 30 mA. The maximum amount of +5 V current available for experimental use, over and above that required by the USB-1208LS, is the difference between the *total current requirement* of the USB device (based on the application), and the *allowed current draw* of the PC platform (500 mA for desktop PCs and self-powered hubs, or 100 mA for bus-powered hubs and notebook computers).

With all outputs at their maximum output current, you can calculate the total current requirement of the USB-1208LS USB +5 V as follows:

$$(\text{USB-1208LS @ 20 mA}) + (16 \text{ DIO @ 2.5 mA ea}) + (2 \text{ AO @ 30 mA ea}) = 120 \text{ mA}$$

For an application running on a PC or powered hub, the maximum available excess current is 500 mA–120 mA = 380 mA. This number is the total maximum available current at the PC+5V screw terminals. Measurement Computing highly recommends that you figure in a safety factor of 20% below this maximum current loading for your applications. A conservative, safe user maximum in this case would be in the 300-320 mA range.

Since laptop computers typically allow up to 100 mA, the USB-1208LS in a fully-loaded configuration may be above that allowed by the computer. In this case, you must determine the per-pin loading in the application to ensure that the maximum loading criteria is met. The per-pin loading is calculated by simply dividing the +5 V by the load impedance of the pin in question.

## Ground terminals

The 10 ground (GND) connections are identical, and provide a common ground for all USB-1208LS functions. Refer to the [pinout diagrams](#) on page 3-4 for the location of the **GND** terminal pins.

## Calibration terminal

The **CAL** connection (pin 16) is an output you should use only to calibrate the USB-1208LS. Refer to the [pinout diagrams](#) on page 3-4 for the location of this pin. Calibration of the USB-1208LS is software-controlled via *InstaCal*.

## Trigger terminal

The **TRIG\_IN** connection (pin 18) is an external digital trigger input. You can configure this terminal with software for either trigger high or trigger low.

## Counter terminal

Pin 20 (**CTR**) is input to the 32-bit external event. Refer to the [pinout diagrams](#) on page 3-4 for the location of this pin. The internal counter increments when the TTL levels transition from low to high. The counter can count frequencies of up to 1 MHz.

## Accuracy

The overall accuracy of any instrument is limited by the error components within the system. Quite often, resolution is incorrectly used to quantify the performance of a measurement product. While "12-bits" or "1 part in 4096" does indicate what can be resolved, it provides little insight into the quality of an absolute measurement. Accuracy specifications describe the actual results that can be realized with a measurement device.

There are three types of errors which affect the accuracy of a measurement system:

- offset
- gain
- nonlinearity.

The primary error sources in the USB-1208LS are offset and gain. Nonlinearity is small in the USB-1208LS, and is not significant as an error source with respect to offset and gain.

Figure 3-10 shows an ideal, error-free, USB-1208LS transfer function. The typical calibrated accuracy of the USB-1208LS is range-dependent, as explained in the "[Specifications](#)" chapter of this document. We use a  $\pm 10$  V range here as an example of what you can expect when performing a measurement in this range.

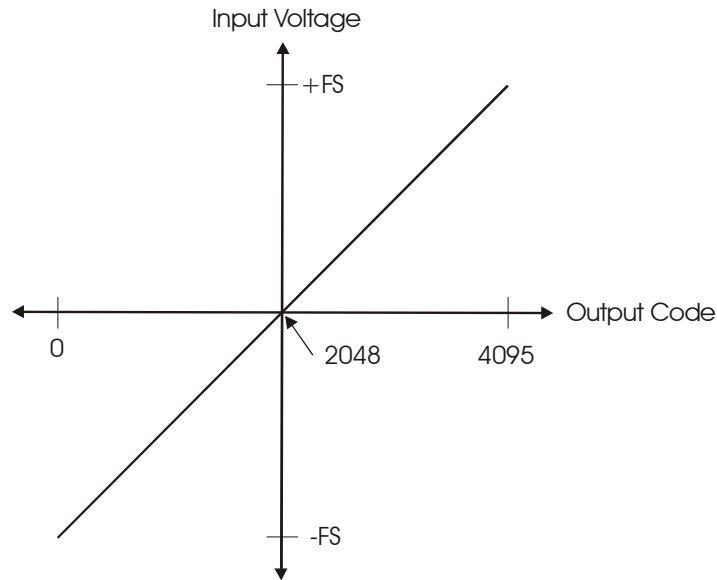

Figure 3-10. Ideal ADC transfer function

The USB-1208LS offset error is measured at mid-scale. Ideally, a zero volt input should produce an output code of 2048. Any deviation from this is an offset error. Figure 3-11 shows the USB-1208LS transfer function with an offset error. The typical offset error specification on the  $\pm 10$  V range is  $\pm 9.77$  mV. Offset error affects all codes equally by shifting the entire transfer function up or down along the input voltage axis.

**The accuracy plots in Figure 3-11 are drawn for clarity and are not drawn to scale.**

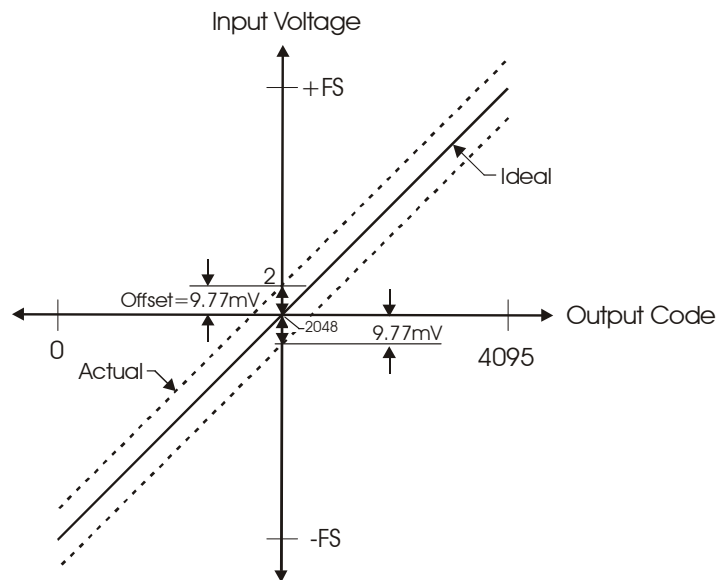

Figure 3-11. ADC transfer function with offset error

Gain error is a change in the slope of the transfer function from the ideal, and is typically expressed as a percentage of full-scale. Figure 3-12 shows the USB-1208LS transfer function with gain error. Gain error is easily converted to voltage by multiplying the full-scale (FS) input by the error.

The accuracy plots in Figure 3-12 are drawn for clarity and are not drawn to scale.

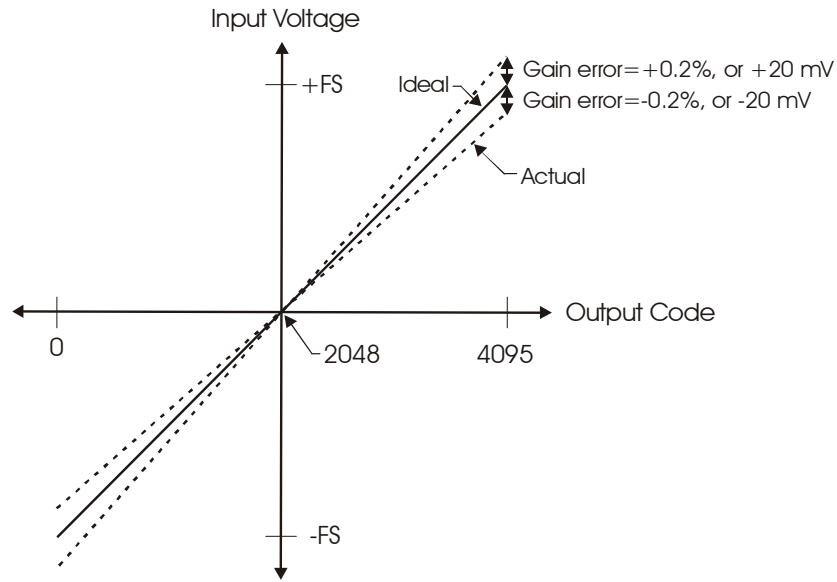

Figure 3-12. ADC Transfer function with gain error

For example, the USB-1208LS exhibits a typical calibrated gain error of  $\pm 0.2\%$  on all ranges. For the  $\pm 10\text{ V}$  range, this would yield  $10\text{ V} \times \pm 0.002 = \pm 20\text{ mV}$ . This means that at full scale, neglecting the effect of offset for the moment, the measurement would be within 20 mV of the actual value. Note that gain error is expressed as a ratio. Values near  $\pm\text{FS}$  are more affected from an absolute voltage standpoint than are values near mid-scale, which see little or no voltage error.

Combining these two error sources in Figure 3-13, we have a plot of the error band of the USB-1208LS for the  $\pm 10\text{ V}$  range. This is a graphical version of the typical accuracy specification of the product.

The accuracy plots in Figure 3-13 are drawn for clarity and are not drawn to scale

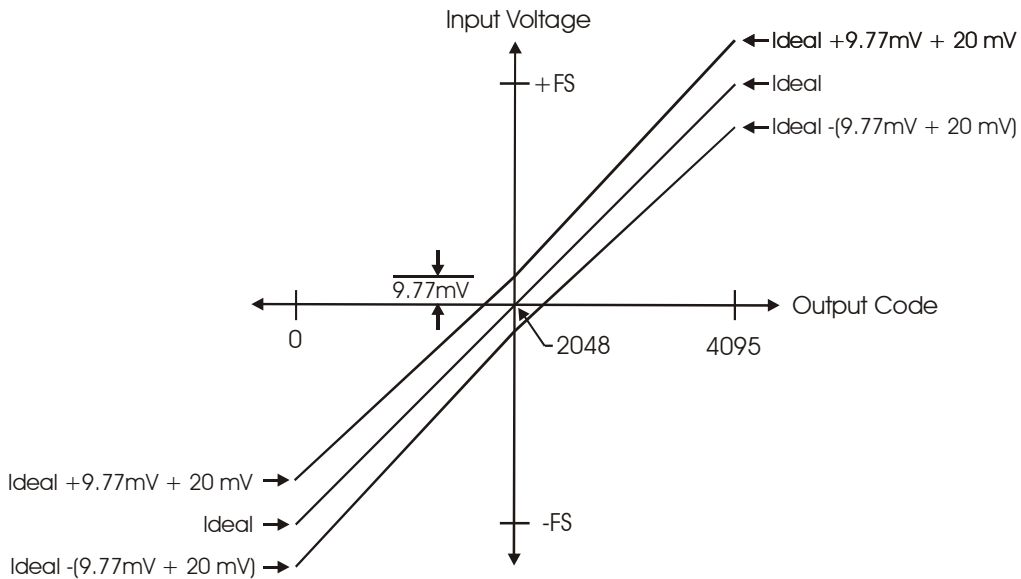

Figure 3-13. Error band plot

## USB-1208LS channel gain queue feature

The USB-1208LS's channel gain queue feature allows you to set up a scan sequence with a unique per-channel gain setting and channel sequence.

The channel gain queue feature removes the restriction of using an ascending channel sequence at a fixed gain. This feature creates a channel list which is written to local memory on the USB-1208LS. The channel list is made up of a channel number and range setting. An example of a four-element list is shown in Table 3-3.

Table 3-3. Sample channel gain queue list

Element	Channel	Range
0	CH0	BIP10V
1	CH0	BIP5V
2	CH7	BIP10V
3	CH2	BIP1V

When a scan begins with the gain queue enabled, the USB-1208LS reads the first element, sets the appropriate channel number and range, and then acquires a sample. The properties of the next element are then retrieved, and another sample is acquired. This sequence continues until all elements in the gain queue have been selected. When the end of the channel list is detected, the sequence returns to the first element in the list.

This sequence repeats until the specified number of samples is gathered. You must carefully match the gain to the expected voltage range on the associated channel—otherwise, an over range condition can occur. Although this condition does not damage the USB-1208LS, it does produce a useless full-scale reading. It can also introduce a long recovery time from saturation, which can affect the next measurement in the queue.



## Specifications

Typical for 25°C unless otherwise specified.

Specifications in *italic text* are guaranteed by design.

### Analog input

Parameter	Conditions	Specification
A/D converter type		Successive approximation type
Input voltage range for linear operation, single-ended mode	CHx to GND	±10 V max
Input common-mode voltage range for linear operation, differential mode	CHx to GND	-10 V min, +20 V max
<i>Absolute maximum input voltage</i>	<i>CHx to GND</i>	<i>±40V max</i>
Input current (Note 1)	Vin = +10 V	70µA typ
	Vin = 0V	-12µA typ
	Vin = -10 V	-94µA typ
<i>Input impedance</i>		<i>122K Ohms</i>
Number of channels		8 single ended / 4 differential, software selectable
Input ranges, single-ended mode		±10V, G=2
Input ranges, differential mode		±20V, G=1 ±10V, G=2 ±5V, G=4 ±4V, G=5 ±2.5V, G=8 ±2.0V, G=10 ±1.25V, G=16 ±1.0V, G=20 Software selectable
Throughput	Software paced	50 S/s
	Continuous scan	1.2 kS/s
	Burst scan to 4 K sample FIFO	8 kS/s
Channel gain queue	Up to 8 elements	Software configurable channel, range, and gain.
Resolution (Note 2)	Differential	12 bits, no missing codes
	Single ended	11 bits
CAL accuracy	CAL = 2.5V	±0.05% typ, ±0.25% max
Integral linearity error		±1 LSB typ
Differential linearity error		±0.5 LSB typ
Repeatability		±1 LSB typ
CAL current	Source	5 mA max
	Sink	20 µA min, 200 nA typ
Trigger Source	Software selectable	External digital: TRIG_IN

**Note 1:** Input current is a function of applied voltage on the analog input channels. For a given input voltage, Vin, the input leakage is approximately equal to  $(8.181 \cdot V_{in} - 12) \mu\text{A}$ .

**Note 2:** The AD7870 converter only returns 11-bits (0-2047 codes) in single-ended mode.

Table 1. Accuracy, differential mode

Range	Accuracy (LSB)
±20 V	5.1
±10 V	6.1
±5 V	8.1
±4 V	9.1
±2.5 V	12.1
±2 V	14.1
±1.25 V	20.1
±1 V	24.1

Table 2. Accuracy, single-ended mode

Range	Accuracy (LSB)
±10 V	4.0

Table 3. Accuracy components, differential mode - all values are (±)

Range	% of Reading	Gain Error at FS (mV)	Offset (mV)	Accuracy at FS (mV)
±20 V	0.2	40	9.766	49.766
±10 V	0.2	20	9.766	29.766
±5 V	0.2	10	9.766	19.766
±4 V	0.2	8	9.766	17.766
±2.5 V	0.2	5	9.766	14.766
±2 V	0.2	4	9.766	13.766
±1.25 V	0.2	2.5	9.766	12.266
±1 V	0.2	2	9.766	11.766

Table 4. Accuracy components, single-ended mode - all values are (±)

Range	% of Reading	Gain Error at FS (mV)	Offset (mV)	Accuracy at FS (mV)
±10 V	0.2	20	19.531	39.531

## Analog output

Parameter	Conditions	Specification
D/A converter type		PWM
Resolution		10-bits, 1 in 1024
Maximum output range		0 -5 Volts
Number of channels		2 voltage output
Throughput	Software paced	100 S/s single channel mode 50 S/s dual channel mode
Power on and reset voltage		Initializes to 000h code
Maximum voltage (Note 3)	No load	Vs
	1 mA load	0.99 * Vs
	5 mA load	0.98 * Vs
Output drive	Each D/A OUT	30 mA
Slew rate		0.14 V/mS typ

**Note 3:** Vs is the USB bus +5V power. The maximum analog output voltage is equal to Vs at no-load. V is system dependent and may be less than 5 volts.

## Digital input/output

Digital type	82C55
Number of I/O	16 (Port A0 through A7, Port B0 through B7)
Configuration	2 banks of 8
Pull up/pull-down configuration	All pins pulled up to $V_s$ via 47K resistors (default). Positions available for pull down to ground. Hardware selectable via zero ohm resistors as a factory option.
Input high voltage	2.0 V min, 5.5 V absolute max
Input low voltage	0.8 V max, -0.5 V absolute min
Output high voltage ( $I_{OH} = -2.5$ mA)	3.0 V min
Output low voltage ( $I_{OL} = 2.5$ mA)	0.4 V max

## External trigger

Parameter	Conditions	Specification
Trigger source (Note 4)	External digital	TRIG_IN
Trigger mode	Software selectable	Level sensitive: user configurable for TTL level high or low input.
Trigger latency	Burst	25 $\mu$ s min, 50 $\mu$ s max
Trigger pulse width	Burst	40 $\mu$ s min
Input high voltage		3.0 V min, 15.0 V absolute max
Input low voltage		0.8 V max
Input leakage current		$\pm 1.0$ $\mu$ A

**Note 4:** TRIG\_IN is protected with a 1.5KOhm series resistor.

## Counter

Counter type	Event counter
Number of channels	1
Input source	CTR screw terminal
Input type	TTL, rising edge triggered
Resolution	32 bits
Schmidt trigger hysteresis	20 mV to 100 mV
Input leakage current	$\pm 1$ $\mu$ A
Maximum input frequency	1 MHz
High pulse width	500 ns min
Low pulse width	500 ns min
Input low voltage	0 V min, 1.0 V max
Input high voltage	4.0 V min, 15.0 V max

## Non-volatile memory

Memory size	8192 bytes		
Memory configuration	<b>Address Range</b>	<b>Access</b>	<b>Description</b>
	0x0000 – 0x17FF	Read/Write	A/D data (4K samples)
	0x1800 – 0x1EFF	Read/Write	User data area
	0x1F00 – 0x1FEF	Read/Write	Calibration data
	0x1FF0 – 0x1FFF	Read/Write	System data

## Power

Parameter	Conditions	Specification
Supply current (Note 5)		20 mA
+5V USB power available (Note 6)	Connected to Self-Powered Hub	4.5 V min, 5.25 V max
	Connected to Bus-Powered Hub	4.1 V min, 5.25 V max
Output current (Note 7)	Connected to Self-Powered Hub	450 mA min, 500 mA max
	Connected to Bus-Powered Hub	50 mA min, 100 mA max

**Note 5:** This is the total current requirement for the USB-1208LS which includes up to 5mA for the status LED.

**Note 6:** Self-powered refers to USB hubs and hosts with a power supply. Bus-powered refers to USB hubs and hosts without their own power supply.

**Note 7:** This refers to the total amount of current that can be sourced from the USB +5V, analog outputs and digital outputs.

## General

Parameter	Conditions	Specification
USB controller clock error	25 °C	±30 ppm max
	0 to 70 °C	±50 ppm max
Device type		USB 1.1 low-speed
Device compatibility		USB 1.1, USB 2.0

## Environmental

Operating temperature range	-0 to 70 °C
Storage temperature range	-40 to 70 °C
Humidity	0 to 90% non-condensing

## Mechanical

Dimensions	79 mm (L) x 82 mm (W) x 25 mm (H)
USB cable length	3 Meters max
User connection length	3 Meters max

## Main connector and pin out

Connector type	Screw terminal
Wire gauge range	16 AWG to 30 AWG

### 4-channel differential mode

Pin	Signal Name	Pin	Signal Name
1	CH0 IN HI	21	Port A0
2	CH0 IN LO	22	Port A1
3	GND	23	Port A2
4	CH1 IN HI	24	Port A3
5	CH1 IN LO	25	Port A4
6	GND	26	Port A5
7	CH2 IN HI	27	Port A6
8	CH2 IN LO	28	Port A7
9	GND	29	GND
10	CH3 IN HI	30	PC+5V
11	CH3 IN LO	31	GND
12	GND	32	Port B0
13	D/A OUT 0	33	Port B1
14	D/A OUT 1	34	Port B2
15	GND	35	Port B3
16	CAL	36	Port B4
17	GND	37	Port B5
18	TRIG_IN	38	Port B6
19	GND	39	Port B7
20	CTR	40	GND

### 8-channel single-ended mode

Pin	Signal Name	Pin	Signal Name
1	CH0 IN	21	Port A0
2	CH1 IN	22	Port A1
3	GND	23	Port A2
4	CH2 IN	24	Port A3
5	CH3 IN	25	Port A4
6	GND	26	Port A5
7	CH4 IN	27	Port A6
8	CH5 IN	28	Port A7
9	GND	29	GND
10	CH6 IN	30	PC+5V
11	CH7 IN	31	GND
12	GND	32	Port B0
13	D/A OUT 0	33	Port B1
14	D/A OUT 1	34	Port B2
15	GND	35	Port B3
16	CAL	36	Port B4
17	GND	37	Port B5
18	TRIG_IN	38	Port B6
19	GND	39	Port B7
20	CTR	40	GND

# CE Declaration of Conformity

Manufacturer: Measurement Computing Corporation  
Address: 10 Commerce Way  
Suite 1008  
Norton, MA 02766  
USA

Category: Electrical equipment for measurement, control and laboratory use.

Measurement Computing Corporation declares under sole responsibility that the product

## USB-1208LS

to which this declaration relates is in conformity with the relevant provisions of the following standards or other documents:

EU EMC Directive 89/336/EEC: Electromagnetic Compatibility, EN 61326 (1997) Amendment 1 (1998)

Emissions: Group 1, Class B

- EN 55011 (1990)/CISPR 11: Radiated and Conducted emissions.

Immunity: EN61326, Annex A

- IEC 1000-4-2 (1995): Electrostatic Discharge immunity, Criteria A.
- IEC 1000-4-3 (1995): Radiated Electromagnetic Field immunity Criteria A.
- IEC 1000-4-8 (1994): Power Frequency Magnetic Field immunity Criteria A.

Declaration of Conformity based on tests conducted by Chomerics Test Services, Woburn, MA 01801, USA in May, 2004. Test records are outlined in Chomerics Test Report #EMI3733.04.

We hereby declare that the equipment specified conforms to the above Directives and Standards.



Carl Haapaoja, Director of Quality Assurance

**Measurement Computing Corporation**  
**10 Commerce Way**  
**Suite 1008**  
**Norton, Massachusetts 02766**  
**(508) 946-5100**  
**Fax: (508) 946-9500**  
**E-mail: [info@mccdaq.com](mailto:info@mccdaq.com)**  
**[www.mccdaq.com](http://www.mccdaq.com)**