

English / Spanish syntactic contrasts: minimalism and optimality

Raquel Fernández Fuertes

English / Spanish syntactic contrasts: minimalism and optimality

Raquel Fernández Fuertes

Abstract

Recent developments in linguistic theory carried out within the principles and parameter model and the minimalist program provide an excellent framework for the comparison of languages. In this study we use said framework to analyze the nature of subjects and their positions in the sentence in English and Spanish. We specifically concentrate on lexical preverbal and postverbal subjects and on the special type of subject present in expletive constructions in order to provide a comparative account of word-order differences and similarities between English and Spanish. We show that the [+/- pronominal] agreement differences are responsible for: 1) the different nature of preverbal subjects in English and in Spanish; 2) the possibility of postverbal subjects in Spanish but not in English; and 3) the different agreement relationships established in existential constructions in both languages.

INDEX

INTRODUCTION	1
1. THEORETICAL BACKGROUND	9
1.1. Generative Theory and the Comparison of Languages	9
1.2. From the Principles and Parameters Model to the Minimalist Program	12
1.2.1. Government and Binding Theory and the Principles and Parameters Model	12
1.2.2. The Minimalist Program	16
1.2.2.1. Building Structures	17
1.2.2.2. The Principles	31
1.2.2.3. Optionality of Movement in the Minimalist Program	44
1.2.2.4. Subject-verb Agreement as a Movement Operation in the Minimalist Program	48
1.3. Antisymmetry	55
1.3.1. Introduction	55
1.3.2. The Relationship between Hierarchy and Linear Order	56
1.3.3. Adjunction	61
1.4. Optimality Theory	63
1.4.1. Optimality Theory and the Previous Generative Tradition	63
1.4.1.1. The Ideal Net: Grammatical <i>versus</i> Ungrammatical Sentences	64
1.4.1.2. Markedness and Constraints	64
1.4.2. Optimality Theory Processes	67
1.4.2.1. <i>Pro</i> and Optimality Theory	70
1.4.2.2. Expletives and Optimality Theory	74
1.5. Other Developments in the Theory	76
1.5.1. Pollock (1989): The Split Inflection Hypothesis	76
1.5.1.1. Tensed Clauses	81
1.5.1.2. Infinitival Clauses	82

1.5.1.3. The Predicate Loc	86
1.5.1.4. Pollock and the Minimalist Program	86
1.5.2. The VP-Internal Subject Hypothesis and Parametric Variation	89
1.5.3. The Pro-drop Parameter	95
1.5.4. Recent Accounts of the Pro-drop Parameter (Null-subject Parameter)	104
1.6. The Theory of Word Order in the Literature	109

2. SUBJECTS 114

2.1. Preliminaries	115
2.1.1. The Principles and Parameters Model, the Minimalist Program and Subjects	115
2.1.2. Agreement Features	120
2.1.2.1 Null-subject Languages and Non-configurational Languages: Pronominal Agreement	129
2.1.2.2. Agreement Possibilities and Binding	132
2.1.3. Subjects: Adjunct / Argument Dichotomy	134
2.1.3.1. Null-subject Languages and Non-configurational Languages: Subjects as Adjuncts	137
2.1.3.2. Doubling Structure: DP and Agreement Clitic	141
2.1.4. The Issue of Terminology	143
2.1.4.1. Rivero (1978, 1980)	144
2.1.4.2. Contreras (1976, 1991)	145
2.1.4.3. Hernanz and Brucart (1987)	149
2.1.4.4. Olarrea (1996)	151
2.1.4.5. Zubizarreta (1998, 1999)	160
2.2. Subject / Verb <i>versus</i> Verb / Subject Orders	164
2.3. Preverbal Subjects	170
2.3.1. Clitic Left-dislocated Constructions and Preverbal Subjects	170
2.3.2. The Position of Preverbal Subjects	173
2.3.2.1. A Unified Account of Preverbal Items and their Positions: Subjects and Objects	176
2.3.3. Preverbal Subjects: Restrictions and Chains	181
2.3.3.1. Lack of Agreement: The Matching of Person Features	185
2.3.4. Left-dislocated Subjects and the Null-subject Parameter	188
2.3.4.1. Preverbal Subjects and Interrogative Sentences: <i>Pro</i> and Lexical NPs	190
2.4. Postverbal Subjects	193
2.4.1. Perspectives on VS Order as a Product of Different Processes	199
2.4.2. A Note on Postverbal Subjects in Declaratives and Interrogatives	205
2.4.3. Postverbal Subjects and Focus: VSO / VOS Structures	214
2.4.4. Fully Referential NPs <i>versus</i> Pronouns as Postverbal Subjects	217
2.5. A Comparison of SV / VS Orders: A Summary	219

3. EXPLETIVES	231
3.1. Introduction: Expletives and Subjects	231
3.1.1. Outline	231
3.1.2. Pleonastic Elements	235
3.1.2.1. An Expletive Typology	235
3.1.2.2. <u>There</u> / <u>It</u> Contrast	241
3.2. Expletives: Preliminary Considerations	244
3.2.1. Existential Constructions in English and Spanish/French	245
3.2.2. Adjunct / Expletive / Locative <u>There</u> and Expletive Referential <i>Pro</i>	248
3.2.3. Expletives <u>There</u> and <i>Pro</i>	251
3.2.4. The Status of V	256
3.2.5. A Typology of NPs	265
3.2.6. Existential and Presentational <u>There</u> Sentences	273
3.2.7. Ergative-expletives and Existential-expletives	274
3.3. Semantic Properties	276
3.3.1. Existential Constructions and the Predicate Loc	276
3.3.1.1. Pollock's (1989) Verbal Typology	277
3.3.1.2. Location and Auxiliaries <u>Have/Tener/Avoir</u>	281
3.3.2. Lexical Doublets	287
3.3.3. Existential Constructions and the Full Interpretation Principle	290
3.4. Syntactic Properties	293
3.4.1. Agreement in Existential Constructions	293
3.4.2. Movement in Existential Constructions: Case and Economy Principles	315
3.4.2.1. Expletive Constructions as a Manifestation of Case Assignment	315
3.4.2.2. Case Transmission and Accusative Case: <u>Be versus Haber</u>	319
3.4.2.3. Inherent Case Assignment and Unaccusatives	323
3.4.2.4. The Motivation for the Movement: Economy Principles	328
3.5. Representations of Existential Constructions	331
3.6. Conclusion	337
 CONCLUSION	 341
 BIBLIOGRAPHY	 352
 LIST OF ABBREVIATIONS	 374

INTRODUCTION

The present study, which takes a generative approach to language, focuses on the comparison of the nature of subjects and their positions in the sentence in English and Spanish. The points of departure are the central cases of the obligatory presence of referential subjects in English (he has arrived), as contrasted with the existence of null subjects in Spanish (*pro* ha llegado). More specifically, we concentrate on an analysis of lexical preverbal and postverbal subjects in English and Spanish; and on the type of subject present in expletive constructions in the two languages.

The main goal of generative grammar is to account for the knowledge of language. In order to achieve this, two main issues have to be considered. The first issue regards those properties that are universal; the second relates to those that are shared by a given group of languages. In a generative framework, these properties are captured in terms of universal grammar (UG) as the theory of the initial state (the biological endowment of the human language capacity), and particular grammars as the theories of attained states (particular individual languages) (Chomsky 1998). Thus, generative linguistics is, by definition, comparative, since

it is necessary to compare the language under analysis with other languages in order to discover, from among the entire set of characteristics defining that language, what is universal and what are language-specific choices. Generative grammar, therefore, provides the necessary tools for this comparative work which is, in our case, a goal in itself.

Within the overall framework of generative grammar, government and binding theory -and specifically principles and parameters theory (PP)- and the minimalist program (MP) constitute the theoretical basis of this work. It is especially from the inception of the PP theory that the model, with comparative analysis at its core, provides more tools to carry out such an analysis: principles refer to universal properties, while properties that are shared by a group of languages are said to be parametrized. Parameters, in this sense, appear as a new way to constrain the variation among languages, a variation that is predetermined. Thus, the pro-drop parameter, for instance, is seen as a constraint dividing languages into two typological groups: those that allow null subjects, like Spanish (Juan ha llegado; *pro ha llegado*); and those that do not, like English (John has come; **pro has come*). This type of analysis is what led to the so-called new comparative syntax.

The two traditional goals, put forward at the early stages of the theory and captured in the PP model, are reformulated within the modern generative grammar. The inherent tension between universal and parametrized properties is nevertheless maintained all along the research inquiry. The MP (Chomsky 1993, 1995) and later advancements in the theory (Chomsky 1998, 1999) attempt to reduce this tension by minimizing descriptive technology; the result is a few well-defined accurate principles that are general enough to account for universal features and, at the same

time, refined enough to capture the differential features. This tension will prove to be challenging for a comparative analysis, since it contemplates both individual and common features among languages. Thus, on the one hand, there is a search for a characterization of the different languages, which may lead to an increasing degree of complexity of rule systems (not only between languages but also among the different grammatical constructions within the same language). And, on the other hand, there is also a search for common ground among languages, which leads to the conclusion that language structure is largely invariant. It should be borne in mind that the MP is a program, not a theory, and as such it is still in its developmental stage and is open to interpretation. This makes the MP a challenging working field.

In order to account for variation both between English and Spanish and within these two languages (interlanguage and intralanguage variation), we make use of several proposals that deal with more specific issues in a comparative analysis. In this respect, we explore the consequences for our analysis of the split inflection hypothesis (Pollock 1989), among others. This hypothesis reflects how verbal inflection contains information on tense mood and, more importantly for our analysis, agreement. More specifically, it deals with how this information, in the case of agreement, for example, may be enclitic in the verb itself, like first person singular -o in Spanish cant-o, or it may be outside of the verb, as a separate lexical item, like I in English I sing. Another proposal, the VP-internal subject hypothesis (Koopman and Sportiche 1985), establishes the universal position in which all subjects are generated (within the verbal phrase) and from which they move to higher positions under certain circumstances and complying to certain requisites. This proposal will prove very useful in explaining the position of postverbal

subjects in Spanish *versus* the case of English, for instance. Lastly, we will make use of the pro-drop parameter (Perlmutter 1971, among others) together with some of its reformulations in terms of other proposals more specifically related to our topic, the analysis of preverbal, postverbal and expletive subjects. We will see, for instance, how the presence of the null subject element *pro* is accounted for in the cases of Spanish lexical preverbal subjects (Ana tiene *pro* unos ojos preciosos), as contrasted with English (Ana has beautiful eyes). Also, proposals like Rizzi's (1991) argue that in Spanish but not in English inflection is pronominal. This is linked to the analysis of *pro* as an element tied to a special type of agreement, verbal inflection. We can even go a step further and see if, at least in the case of expletive constructions, third person default agreement (Schütze 1999) or null agreement (Kato 1999) can be analyzed as the real subject, thus substituting *pro* (hay un libro).

Even when researchers share fundamental assumptions of a common framework, substantial disagreements occasionally arise. This is the case of Schütze's (1999) default agreement and Sobin's (1997) virus theory for the analysis of agreement in expletive constructions. Both accept the peculiar agreement relationship established in English between verb and postverbal NP (there are books; there is a book), but while for Sobin (1997) this is the result of a grammatical virus, for Schütze (1999) it is generated by the grammar proper. We will see how and at which level these and other proposals help to accommodate the comparative analysis of subjects in English and Spanish, and the possible different adjustments that may be made in order to get to a refined enough analysis that clearly captures the similarities as well as the differences between the two languages.

The main body of the study is organized as follows. In chapter one, we state the theoretical basis on which this analysis is founded. The chapter presents an overall perspective of the gradual progressive change and development in generative grammar, especially from the PP theory to the MP, including recent proposals framed within the MP such as antisymmetry (Kayne 1994) and optimality theory (Prince and Smolensky 1993, Archangeli and Langendoen 1997). Once this theoretical framework is delimited, we will focus on our analysis and offer a comparative study of different issues in English and Spanish. Taking as a point of departure, then, the theoretical background presented in chapter one, chapter two and three deal with the analysis of subjects in English and Spanish, preverbal / postverbal subjects and expletives respectively. Chapter two deals with SV / VS orders, the way they are generated and the differences that exist between the two languages, including different existing positions and their pragmatic value. Chapter three concentrates on the analysis of existential constructions and includes both semantic and syntactic properties, once an expletive typology has been provided.

The subject, the external argument of the predicate, may appear in three different positions: 1) it may remain within the verb phrase where it is generated, this being a universal position (as in postverbal subjects in Spanish); 2) it may raise to inflection to check information on person, number and tense (as in subjects in English); and 3) it may raise to the complementizer position or, in any case, a position higher than inflection, if it has some special interpretation such as focus, topic, etc. that requires it to be so (as in preverbal subjects in Spanish). Our analysis concentrates on how these positions are filled, by which type of elements and what type of relations they trigger. We bring up some of the problems that are

present in the analysis of subject positions. Specifically, we will address three problematic issues: 1) the nature of lexical preverbal subjects in English and Spanish in terms of positions and operations involved (adjunction or movement); 2) the presence of postverbal subjects in Spanish *versus* their absence in English; and 3) the subject element in expletive constructions in English and Spanish, with a focus on agreement properties.

Chapter two focuses on the first two issues. Since in terms of superficial structures, word-order differences may not appear, as in the case of preverbal subjects, we need to turn to an analysis that gives us a more refined insight on the actual differences that do exist between, for instance, preverbal subjects in English and preverbal subjects in Spanish, in spite of an apparent similarity. Also, well-known properties of subjects in Spanish include the fact that free inversion of a subject NP is possible, thus leaving the preverbal subject position empty, as in the cases of null subjects where a pronominal subject is not phonologically spelled out. We analyze the relationship between these two properties that are applicable in Spanish but not in English.

Chapter three concentrates on expletive constructions and on how the notion of subject is to be applied in these cases where a non-argumental element is placed in subject position; since this element does not refer to any specific entity, it is called an expletive. We will see that syntactic elements which have no semantic significance raise important questions about how the semantic and the syntactic components interact, and that this is especially true in the case of pleonastic NPs. This is so because they occur as subjects of clauses, in a position usually reserved for NPs, denoting an argument of a lexical head and the subject of the main semantic predicate of the sentence.

In fact, from the comparison between languages such as English and French, it is assumed that expletive constructions in Spanish must have an elliptic or covert 3rd ps expletive element. The possibility of null subjects is then related to the lack of the equivalent expletive there in Spanish (Jaeggli 1981) and the presence of *pro_{expl}* (Rivero 1980) (there is a book; *pro* hay un libro). Since Spanish generally allows for null subjects, it lacks overt expletives. In view of this difference, it is also our aim to present a uniform account of the cross linguistic distribution of overt expletives (there in English) and covert ones (*pro_{expl}* in Spanish). We start from the idea that in languages such as Spanish, subjects can always be dropped, which is the property that distinguishes Spanish from languages with overt expletives, such as English.

Our analysis will also focus on the relationship between the element in subject position (the expletive there and *pro*) and the postverbal NP (the associate a book and un libro), and also on the type of verb in these structures (a relevant factor for movement operations).

Since Chomsky (1980), the analysis of expletive constructions in English has been based on a movement relation between the expletive and its associate: the associate a book moves to subject position where there is located and, once in subject position, subject-verb agreement is carried out. The type of relation and the different characteristics associated with it change depending on the proposal, but the movement view always remains, especially because an analysis of expletives in terms of movement aims at solving the contradiction of having subjects that are syntactic elements with no semantic interpretation. In this sense, subject position is filled with an NP, the associate, moved from its original postverbal position. Two minimalist premises as well as the case of Spanish will challenge this movement

analysis: 1) it will be necessary to explain then the actual presence of there and *pro* and account for the different properties these elements have; and 2) since language is economical (captured in the minimalist principles of economy) and all operations in a language have to be reduced to the minimum, it will be necessary to determine why a movement operation is needed and how this operation is carried out.

The theoretical analysis of subject positions and the nature of subjects that we provide in this study is based on a large body of specific examples and also includes data from languages other than English and Spanish. In this respect, the comparative perspective adopted may be relevant not only for grammatical description, but also for the underlying theory of a more applied tendency ranging from text books to translation, including automatic translation and even computer programming.

1. THEORETICAL BACKGROUND

1.1. Generative Theory and the Comparison of Languages

The ultimate aim of generative grammar is to account for the knowledge of language. In order to achieve this, any generative analysis will have to address the properties of the language in its two dimensions, universal and specific. Universal properties are shared by all languages, while language-specific properties, although they can be shared by a group of languages, define languages in a more individual and particular way. This double aspect of language that includes universal and specific properties parallels the concepts of universal grammar (UG) and the so-called principles and parameters theory (PP theory). Generative linguistics develops a theory of the human language faculty and how language is acquired, which is general enough to capture the universal features of language, and flexible enough to account for the variability that is in fact observed among specific languages.

Recent developments in generative grammar, specifically the minimalist program (MP) (laid out in Chomsky 1993 with more recent modifications of the

model in Chomsky 1995, 1998 and 1999), consider two interface levels, as in diagram (I). The two levels of representation of the structure of a sentence in a grammar are LF (logical form) and PF (phonetic form). At LF, representations include only semantic features and at PF representations include only phonetic features.¹

Diagram I

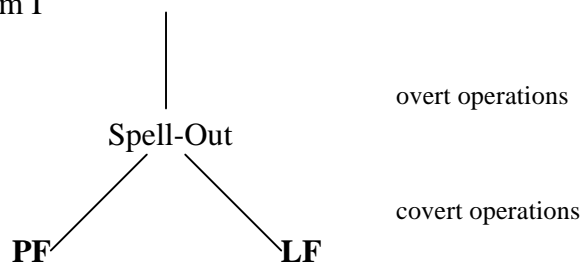

It is assumed that the conceptual-intentional performance system is universal and therefore must be identical in all languages. The underlying idea is the condition of uniformity at LF. On the other hand, the PF interface (the overt realization or Spell-Out of a sentence) varies from language to language. Therefore, languages differ from each other in their overt (explicit) syntax, but not in the covert (implicit) component.

An approach to language such as this one, that distinguishes common properties between languages, but that also accounts for the degree of variation existing between them, will obviously be relevant to the comparative study of languages. In fact, we can even claim that generative linguistics is, by definition, comparative. Comparing or contrasting languages under the generative approach has little in common with the ultimate goal of XIXth century comparative grammar which was mainly historical since it focused on establishing relations of parenthood

¹ A feature is defined as a linguistic property, as most recently done in Chomsky (1999).

between languages. Generative grammar is also very useful for historical linguistics, specially for studies on diachronic syntax, and great insights are gained with the combination of historical and generative perspectives (see, for instance, all the work by Lightfoot, Roberts, Adams, etc.). The main point of divergence between XIXth century comparative studies and recent ones is the descriptive nature of the former *versus* the explanatory nature of the latter. In that sense, the main idea in the comparative generative approach is to account for the entire set of characteristics that define a given language and to distinguish, by means of the comparison to other languages, which properties are universal (and, therefore, shared by all languages), and which ones are language-specific choices determined by UG.

In order to proceed with our comparative analysis of English and Spanish, we will first present the theoretical basis for our study. This includes both general treatments within the generative tradition, and also more precise proposals that deal with word order and word-order effects, this being the main focus of our analysis.

The main word-order issues that we will address here are the relative position of the subject and the verb and the consequences the different orderings may trigger in English and Spanish. Other languages, primarily French, will also be used in order to provide a clearer view of the proposals, as well as specific argumentation in the comparative analysis. Both English and Spanish are characterized as SVO languages as far as word order is concerned. However, although they share a common universal basis, a generative approach to the study of these languages will provide a more refined account that will include not only points of convergence but also the specific properties that make these languages differ from each other.

1.2. From the Principles and Parameters Model to the Minimalist Program

1.2.1. Government and Binding Theory and the Principles and Parameters Model

In early generative grammar, languages were conceived as complex systems of rules that were both construction-particular and language-particular. As opposed to this view, the PP approach stresses universality among languages.

First, the government and binding theory (GB theory) and later, the PP model have been concerned with the underlying universal properties as well as variation among languages.² So, unlike other approaches to the study of language, where the focus is often on the study of one specific language, generative linguistics approaches language in general, as a species-specific endowment. The generative linguist tries, therefore, to provide a presentation of the native speaker's internal knowledge of language (genetic and psychological).

Part of this internal knowledge of the language is said to be innate to the human species and is called universal grammar (UG). Therefore, UG is a system that contains the principles and rules that are common to all human languages. As Chomsky (1981, 7) himself states, "universal grammar may be thought of as some system of principles, common to the species and available to each individual prior to experience". Nevertheless, UG knowledge is not enough to speak a language. Besides, while certain grammatical principles and rules are universal, it is also true

² In this chapter, we provide an overview of those aspects of the theory which are relevant to our comparative analysis of word order. For a survey of the development of the theory see Riemsdijk and Williams (1986). The different developments within generative linguistics, starting from Chomsky (1957, 1965), include standard theory and extended standard theory; both are previous models to GB theory (Chomsky 1981) which will be our starting point. In GB theory, as opposed to previous models, comparison starts playing a central role, being now considered a goal in itself. Chomsky (1991) expresses reservations about the label GB theory and refers to the theory we are concerned with here as the PP theory.

that there is a lot of variation among the different languages, to a greater or lesser degree, depending on the languages under analysis. Exposure to a given language is required in order to set knowledge of how UG principles are realized and to achieve parametrized language-specific properties.

If we focus on word order, for instance, we immediately observe clear differences between languages such as English and Spanish and languages like Japanese. While components such as subjects, verbs and objects are present in all these languages, (these being notions available in all languages), their ordering in the sentence varies from one to the next. Thus, while English and Spanish are considered SVO languages, Japanese is an SOV language, as the examples in (1)-(3) reveal, respectively:

(1) John hit Mary

(2) Juan le pegó a María
 [Juan her-clitic hit-3rdps-past to María]

(3) John ga Mary o but-ta
 [John particle Mary particle hit-past]³

While in English and Spanish the object follows the verb, in Japanese the object precedes the verb. This difference in the linear order of the constituents is captured in the PP model by means of a parameter, the so-called word-order parameter (Kuno 1973, Zwart 1993, Haegeman 1994, Kayne 1994, Haegeman and Guéron 1999).⁴

³ From Kuno (1973).

⁴ The word-order parameter and the directionality parameter refer not only to SV order but to the order in any head (as in D/N *versus* N/D, for instance). Notice that now these parameters have been reinterpreted and word-order differences are explained in terms of features.

Parameters, therefore, account for the variation that exists between languages; or, put in a different way, parameters offer a group of values from which languages select and so each language may present different settings or values of a certain parameter. In the process of language acquisition, parameters are fixed by the person learning a language according to the data they are exposed to. The above mentioned differences between English/Spanish and Japanese are, therefore, the result of parametric variation even though these have been accounted for in rather different ways as the various models attempt to refine the explanatory power of the theory.⁵

As Haegeman and Guéron (1999) summarize, UG contains a set of absolute universals, notions and principles which do not vary from one language to the next. Some of these universal principles are parametrized so that UG offers a range of choices for language-specific properties which vary cross-linguistically; these are, therefore, not fully determined by UG, although UG does provide for the [+/-] open parameter dimension. This may be viewed as a contradiction within the model since we are dealing with universal and less-universal properties.⁶

As noted before, when studying a particular language from a generative approach, we need to determine which characteristics of this particular language are universal, which properties are language-specific and how these relate to the parameters of UG. This type of study proves to be very fruitful for the comparison

⁵ Although a more detailed account of parameters can be provided, for the present analysis we simply refer to the issues that are relevant for our comparative analysis. The definition of a parameter is far from being fixed, although there seems to be some agreement with respect to defining parameters as [+/-] features of functional categories (Borer 1984, Chomsky 1991, Atkinson 1992, Licerias 1997 and references therein). In previous models, only one feature may, and in fact usually did, account for the existence of a parameter so that a certain property determined a parameter and from there a number of properties were derived, like in the directionality parameter or the pro-drop parameter.

⁶ As we will see later on, optimality theory deals with this contradictory section of non-universality within UG.

of languages, since it gives a full account in terms of principles. Moreover, through the analysis of a selection of properties, this theory helps to determine the universality or the specific nature of the characteristics of each language analyzed.

In order to clearly illustrate the workings of this theory, let us briefly discuss the application of one principle (the extended projection principle, EPP) and one parameter (the pro-drop parameter) in the comparative study of English and Spanish. The EPP, as a principle of UG, establishes that all sentences must have a subject. See the examples in (4)-(6) for English, Spanish and French, respectively:

- | | | |
|-----|------------------------|-----------------------|
| (4) | Manuel / he has sung | * <i>pro</i> has sung |
| (5) | Manuel / él ha cantado | <i>pro</i> ha cantado |
| (6) | Manuel / il a chanté | * <i>pro</i> a chanté |

As the previous examples reveal, the three languages comply with the EPP either by the presence of a lexical NP as subject (Manuel) or of a personal pronoun (he, él, il). On the other hand, languages that select the pro-drop parameter can drop their subject pronoun, having *pro*, a non-overt NP with the features [-anaphor, + pronominal], in its place.⁷ *Pro* is a universal category provided by UG but it does not occur in the same positions in all languages. As the previous examples reveal, subject pro-drop is not realized in all languages. Thus, while the syntax of Spanish allows a pronominal subject to be left unexpressed, this is not the case in English or French.

⁷ See following sections for a more detailed account.

Within the PP framework, those language-specific phenomena that may be shared by different languages but that do not constitute parameters in themselves should also be considered.⁸ Since not every syntactic phenomenon has been defined in terms of parameters and since one single property does not qualify, in principle, as a parameter, when comparing languages, the analysis should treat those properties that are not comprised in a parameter but that nonetheless somehow define the idiosyncrasy of a given language.

1.2.2. The Minimalist Program

Within the MP, as in the PP approach described before, universality among languages is still stressed. As in the previous model, UG captures this idea since it provides a fixed system of principles and a finite set of finitely valued parameters; language-particular rules are, therefore, reduced to a choice of values for these parameters.

The transition from the PP approach to the MP is marked by conceptual differences in terms of the levels of structure, the nature of principles, etc.⁹ Within the MP, principles of economy are going to become more and more relevant and it will be mainly on the basis of these principles that the previous PP approach will be turned into the MP.

In the following sections, we will present the different parts of the model, focusing first on the levels of structure and then on the principles of economy and movement relationships.

⁸ This is a very sketchy view of the PP theory. Notions such as competence and performance of an individual, the core and periphery of a language, among others, should also be taken into account. For a more detailed account see Chomsky (1995), specifically chapter one by Chomsky and Lasnik.

⁹ See Marantz (1995) for overall conceptual differences between the PP theory and the MP and also Chomsky (1998, 1999) for the latest versions of the model.

1.2.2.1. Building Structures

Within the new approach, the different levels of analysis to be considered are the first ones to be altered, since they are the building blocks of the entire theory and further consequences develop from them. An attempt to capture the transition from one model to the other is reflected in the following diagrams (II) and (III). They show the difference between DS and SS in the previous model and how SS has turned into Spell-Out, which is no longer a level of analysis, in the new model.

Diagram II
pre-minimalist levels of representation

lexicon + PS rules (X-bar principles)

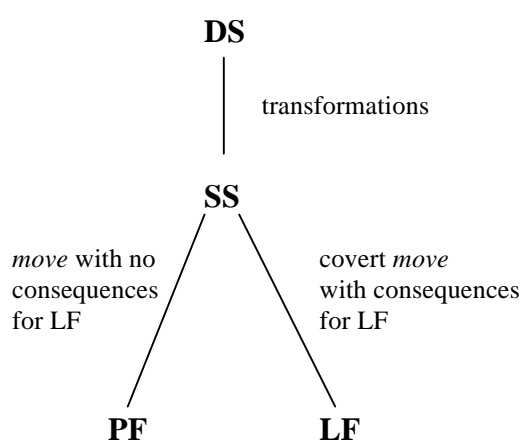
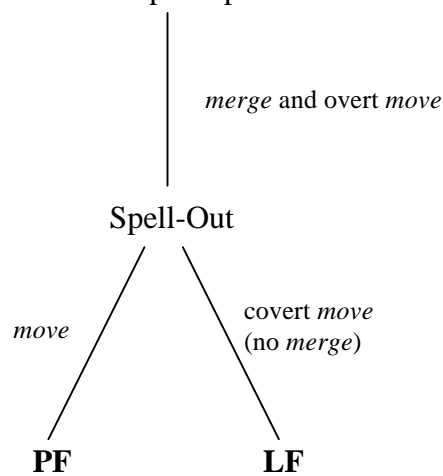

Diagram III
minimalist levels of representation

lexicon and some principles of



As seen in diagrams (II) and (III), several changes appear when comparing the two proposals. Within GB there were four distinct levels, as diagram (II) reveals, each one with its own properties. These four levels are Deep Structure (DS), Surface Structure (SS), Phonetic Form (PF) and Logical Form (LF).

The MP, as in diagram (III), defends the existence of just two minimal and

indispensable levels: the PF level with phonetic properties (that ensure the well-formedness as far as sound is concerned, which accounts for speech perception and pronunciation); and the LF level with semantic properties (that ensure meaning providing as well a set of concepts which are interpreted and conveyed). This reduction to two interface levels is based on the assumption that DS and SS levels are no longer needed since they do not form an interface directly with the final result.¹⁰ Therefore, a level of representation (PF or LF) of the structure of a sentence is a stage in a derivation at which representations comprise only features of a single type (either phonetic or semantic).¹¹ By contrast, the grammatical structures produced by *merge* or *move* operations do not constitute a separate level of representation, since they contain three different sets of features (phonetic, grammatical and semantic). The derivations will no longer be considered grammatical/ungrammatical, but rather, following the new terminology, they will have to converge both at LF and PF in order to be accepted; failing to converge will make a derivation crash.

Along these lines, S-structure conditions on raising and lowering (examples 7 and 8) are discarded in favor of morphological properties of lexical items. This gives way to two types of operations: *merge* and *move*.

(7) NP subject-raising

they_i seem t_i to have many friends

there_i seems t_i to be a nice view from the balcony

¹⁰ PF is assumed to be the structure that interfaces with the perceptual system in speech recognition and with the articulatory system in speech production. LF interfaces with a speaker's general knowledge and with extralinguistic cognitive systems (the systems involved in relating LF to meaning in the intuitive sense).

(8) agreement lowering to lexical V

(he) eat-s ... [AGRP 3rdps [TP past [VP eat]]] ...
 ... [AGRP t_i [TP t_j [VP eat-3rdps-past_j]]] ...

Therefore, the new emphasis on the morphological properties of lexical items results on a reanalysis of raising operations, such as the one in (7), and lowering ones, such as the one in (8), in terms of other type of operations.

Thus, the operations involved in the process of constructing a sentence could be presented as follows:

1. *Select and project*: a word already fully inflected from the lexicon is selected.¹²

Then, if the word is a head (a lexical category or an empty category), it projects according to X-bar structure (if it is a complement, it does not project), as shown in (9):¹³

(9) verb: sing

complement: song

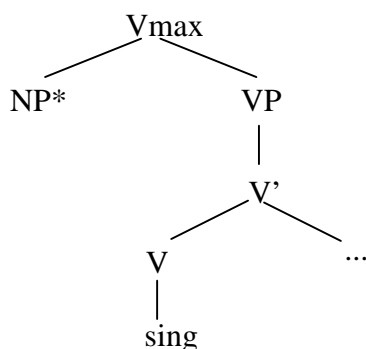

2. *Merge and agree*: another item is taken to merge with the previous item in order

¹¹ The derivation of a given structure is a representation of a set of *merge* and *move* operations used to form the structure (Radford 1997a, 1997b).

¹² See Chomsky (1998, 1999) for subsequent access to a subset of the lexicon (LEX) much in the manner of distributed morphology (Halle and Marantz 1993).

to fill the slot created by the projection, as song in (9) will merge with sing in the empty slot, as in (10):

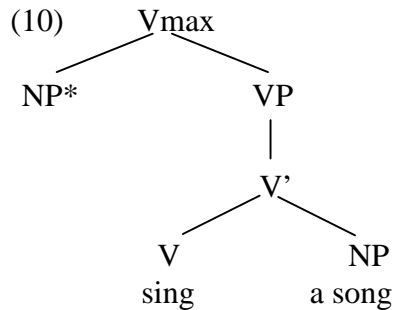

Any operation of merging must be completed before Spell-Out, since after Spell-Out nothing else can be added to the derivation. By means of the operation *agree*, some kind of relation is established between the merged elements in terms of lexical items and their features.¹⁴ Unlike *merge*, *agree* is language-specific.

3. *Move*: this operation combines the two previous ones, *merge* and *agree*, and so establishes agreement between the lexical item and the features, and merges them into a phrase that is determined by these features (but these features are not necessarily its maximal projection) and headed by the lexical item. Like *agree*, *move* is also language-specific.

¹³ NP* corresponds to the external argument of the verb (i.e. the subject), to differentiate it from the NP object (an internal argument of the verb).

¹⁴ As we will see in further sections, this operation (*agree*) will be very important for the analysis of there constructions, as well as for the differences between English and Spanish.

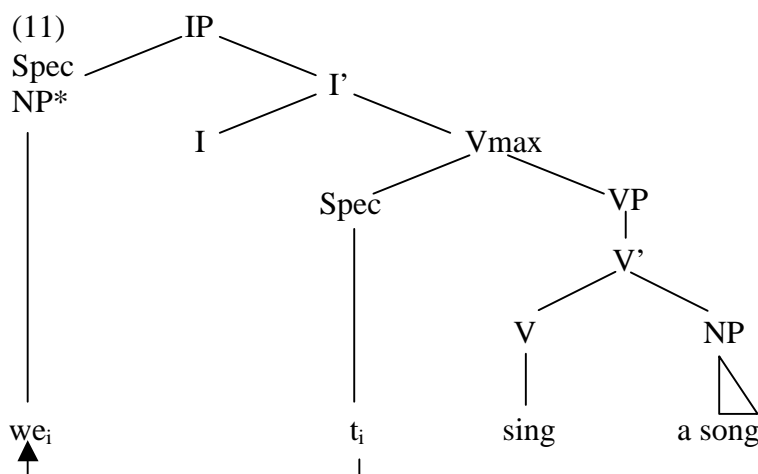

As we will see later in detail, the position in which subject elements generate is the specifier of the verb phrase. From this position and in the case of English, subjects overtly move to the specifier of the inflection phrase, as in (11).¹⁵

Any movement operation either overt or covert must be justified by principles of economy. The division between covert and overt movement brings about, right from the very beginning, the minimalist concept of feature movement as opposed to category movement, which are both movement operations. Overt movement takes place before Spell-Out, while covert movement takes place after Spell-Out. When dealing with Verb-movement, for instance, the movement is overt when in order to check strong V features in Tense the entire the verb has to move up; and it is covert when only the features that are necessary for convergence are moved.¹⁶ Contrary to *merge*, *move* creates checking relations. Checking theory has

¹⁵ See section 1.5.2. and chapter two for a detailed analysis.

¹⁶ The concept of pied-piping makes reference to a process by which a moved constituent or set of features drags one or more other constituents or sets of features along with it when it moves. The example in (ii) shows pied-piping:

- (i) who were you talking to?
- (ii) to whom were you talking?

In (ii), the preposition to is pied-piped along with whom. See also Chomsky (1995).

to apply in all cases of movement, whether it is an abstract checking or whether it is the whole category that moves. In checking theory, items carry grammatical features that have to be checked in the course of the derivation. So, as we will see in the following examples (12) and (13), an element moves to check its features; with this operation, the element makes its features match the features of the position to which it is moving. Thus, an agreement relationship is established between the initial position of the element and the final one to which the element itself or only its features move.

The following examples in (12) and (13) show the operation of covert movement in English and overt movement in Spanish respectively. The presence of the NP all/todos makes visible the different type of verb movement operating in English and Spanish: ¹⁷

- (12) our friends all go to the university ... [IP ▲ [VP all go]]
- *our friends go all to the university¹⁸

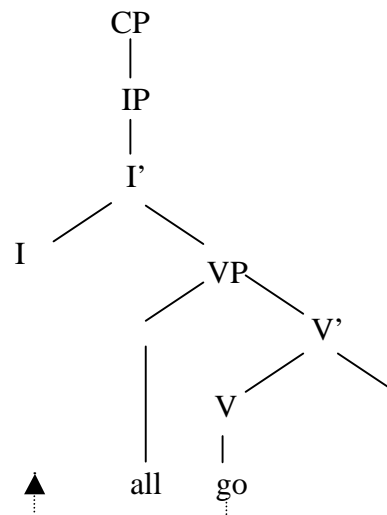

¹⁷ Overt movement or category movement will be presented in the tree diagrams by means of a continuous line, as in (13) above, while a discontinuous line will correspond to covert movement or feature movement, as in (12) above.

¹⁸ Ungrammatical unless given a specific reading-pause with special emphasis on all, therefore rendering marked structures, as in (i) and (ii):

- (i) our friends go ‘ ALL ‘ to the university
- (ii) nuestros amigos ‘ TODOS ‘ van a la universidad

In (12), only the Person, Number and Tense features of go raise to IP to be checked (3rdpp and present tense), while the verb remains *in situ*. Since only the features of the verb, and not the verb itself, move, it is a covert movement.

- (13) *nuestros amigos van todos a la universidad ... [IP van_i [VP todos t_i]] ...
 *nuestros amigos todos van a la universidad

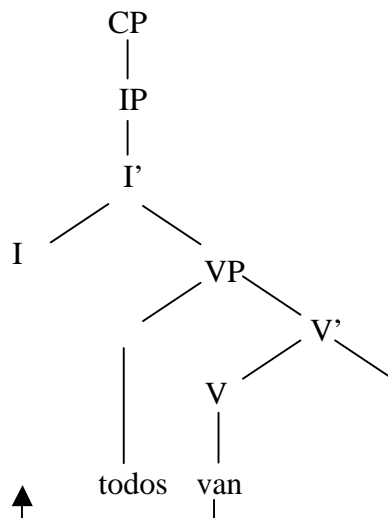

In (13), in order for the verb to check its features and thus converge at LF, overt movement has to apply and the entire verb is raised to IP. The difference between overt and covert movement is related to the principles of economy affecting all languages and also to the particular nature of IP in the different languages. As we will see, covert movement is preferred to overt movement, following the economy principle of procrastination. Also, the [+ strong] feature in IP in Spanish triggers overt movement as opposed to the [- strong] feature in English.

The new developments within the MP in Chomsky's (1998, 13) *minimalist inquiries* (MI) and also Chomsky (1999) further reduce the complexity involved in these operations. The main points are the following:

- 1) reduced access to the lexicon (LEX): derivations make a one-time selection of a

lexical array (LA) from the lexicon. In this way, the derivation does not access the lexicon at every point.¹⁹ This implies that the information contained in LEX, once it is selected, will no longer be needed. Thus, the derivation will not have to carry LEX along and therefore burden complexity is reduced.

2) reduced operative complexity: a language makes a one-time selection of a subset of features (F) dispensing with further access to it. At the same time, there applies a one-time operation that assembles elements of the subset of features into elements of the lexicon to build an expression (EXP). Therefore, both feature selection and feature-element assembling are operations that apply once and only once; when the corresponding features are selected and assembled to an element, no further *select/merge* operations will take place.

The consequence of these reductions is an overall simplification of the process of building up a structure, placing features at the forefront of syntax. Minimalist premises are therefore kept; these reductions further specify the way operations such as *select* and *project* are to be performed. In that sense, *select* is a one-time non-recursive operation that consists of the following steps:

- Select [F] from the universal feature set F
- Select LEX, assembling features from [F]
- Select LA from LEX
- Map LA to EXP with no recourse to [F] for narrow syntax

Thus, an expression is a set of interface representations {PF, LF}: {PF} are symbolic objects at the sensorimotor interface and {LF} are objects at the

¹⁹ As we will see, in the case of expletive constructions, Chomsky (1998) also defends the cyclic

conceptual-intentional interface. Moreover, a linguistic item is a collection of phonetic, semantic and formal features. Phonetic features are accessed in the phonetic component, ultimately yielding a PF-interface representation; semantic features are interpreted at LF; and formal features are accessible in the course of the narrow-syntactic derivation. Semantic and formal features intersect, but there is a subset of formal/phonetic features that does not correspond to semantic features. This is the case for the features in T, for instance, which are uninterpretable formal features that appear, *prima facie*, to violate conditions of optimal design; and also the case of expletives, phonetic features with no semantic interpretation that as such should not appear in the final outlay of an expression.²⁰

Chomsky's (1998) MI restricts the basic operations to *merge* and *agree* that satisfy minimalist conditions. These operations are based on feature matching (identity) and driven by suicidal greed; that is, once feature matching has taken place, matched features are deleted.²¹

The elementary operation pure *merge* has two cases: *pair-merge* (adjunction) and *set-merge* (substitution). *Pair-merge* in (14a) refers to a Spec-head relation, like the one between the VP-internal subject and V; *set-merge* is exemplified in (14b) with the verb-inflection relationship:

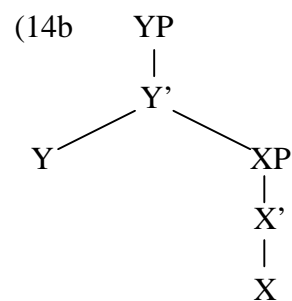
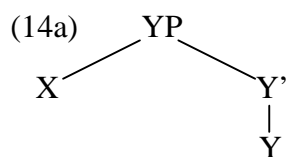

approach to accessing lexical arrays.

²⁰ We will deal with expletives in chapter three.

Pair-merge refers to a Spec-head relationship. It has an inherent asymmetry: X is adjoined to Y. Given the asymmetry, the adjoined element X leaves the category type unchanged; the target Y projects. *Set-merge* is symmetric, so one might expect either X or Y to project. But *set-merge* also has an inherent asymmetry so that, when X and Y merge, it is to satisfy the requirements of one (the selector) but not of both.

The distinction between substitution and adjunction, following Chomsky (1998), is captured in table (I):

Table I: substitution <i>versus</i> adjunction	
<i>pair-merge</i>	<i>set-merge</i>
- it has no selector	- it has a selector
- it is optional	- it is obligatory
- it is an asymmetrical operation	- it is a symmetrical operation

In this respect, language design is close to optimal and provides only the necessary information for an operation to project a certain structure Z: Z is determined by the operation itself, if the operation is symmetrical, but a selector is needed to determine Z if the operation is asymmetrical. Accordingly, *merge* has a selector for *set-merge* but not *pair-merge*.

The second elementary operation is *agree*. It is clear that there are (LF) interpretable inflectional features that enter into agreement relationships with interpretable inflectional features. Thus, the phi-features of T (within IP) are

²¹ Chomsky's (1999) match is not strictly speaking identity but rather non-distinctness: same feature, independently of value.

uninterpretable and agree with the interpretable phi-features of a nominal that may be local or remote, yielding the surface effect of noun-verb agreement under IP. The agreement relation removes the uninterpretable features from narrow syntax, therefore allowing derivations to converge at LF while remaining intact for the phonetic component (with language-variant PF-manifestation), as in (15):²²

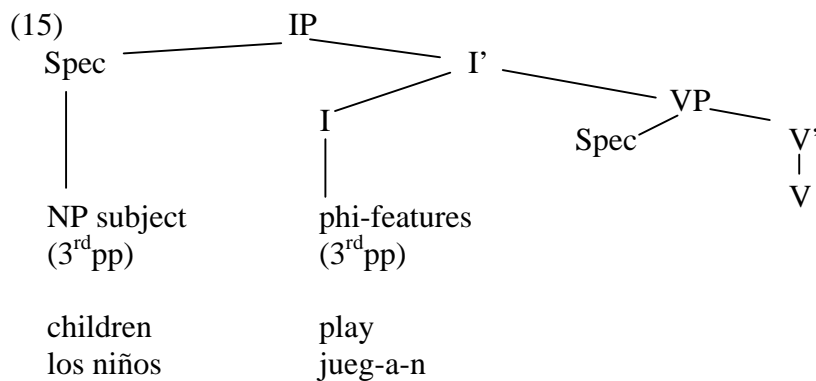

The relationship between *merge*, *agree* and *move* bears on the analysis of expletives. This is illustrated in the examples in (16a) and (16b):

- (16) [IP I be [a proof discovered]]
- a. *merge + agree*: there was a proof discovered
- b. *move*: a proof was discovered

If an expletive is available, *merge* combined with *agree* (the latter to establish the IP-postverbal NP relation) applies, as in (16a). *Move* does not apply since it is a

²² Narrow syntax refers to the computation of LF (Chomsky 1999). Narrow syntax maps a selection of choices from the lexicon to LF, so that the set of features as such is not accessed; only the lexicon and the features of its items are accessed (Chomsky 1998). The phonetic component, in contrast, does not have any such restrictions (as we will see in the case of expletives) and has further access

more complex operation; also the derivation will crash with an unused expletive. *Move* applies if no expletive is available, as in (16b), so that the NP a proof appears in preverbal position.

The operations that we have described take place in the process of sentence creation. The tree diagram in (17) reflects the processes of *merge* and *move*. This last process takes place both before and after Spell-Out (overt and covert *move* respectively):

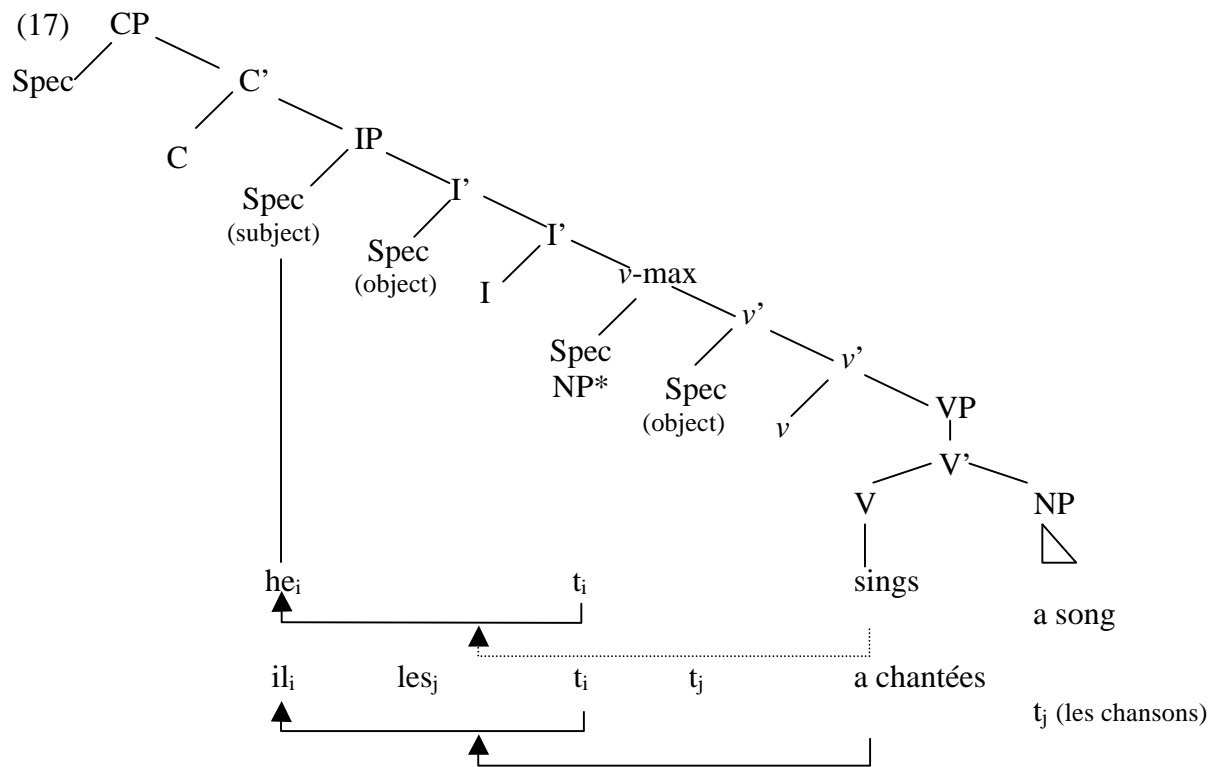

Again, in the case of English, V-movement is a covert operation whereby only the verbal features in VP rise to IP to be checked and to match these features with subject features. French V-movement is overt so that the entire verb, rather than only its features, raises to IP. The features of the verb are matched with the subject

to the set of features a language selects. Features are introduced in the course of the computation and in different ways for the different languages.

features in [Spec IP], as in English, and also with object features (French shows AgrO with clitic pronouns in preverbal position with avoir). Moreover, since simpler operations are preferred over more complex ones, *agree* is preferred over *move*. *Move* is a last resort, chosen when nothing else is possible; when, as in the case of French, rich inflection triggers the overt raising of the verb. This proposal is at the basis of one of the economy principles (procrastinate), as we will see later.

Thus, even if verbs come fully inflected from the lexicon (Tense, Person, Number, Gender ...), inflection nodes must be kept in the tree because they are needed for checking purposes. The tree in (18) presents the different inflectional nodes (Mood, Agreement Subject, Tense and Agreement Object) for the English verbal form they eat:

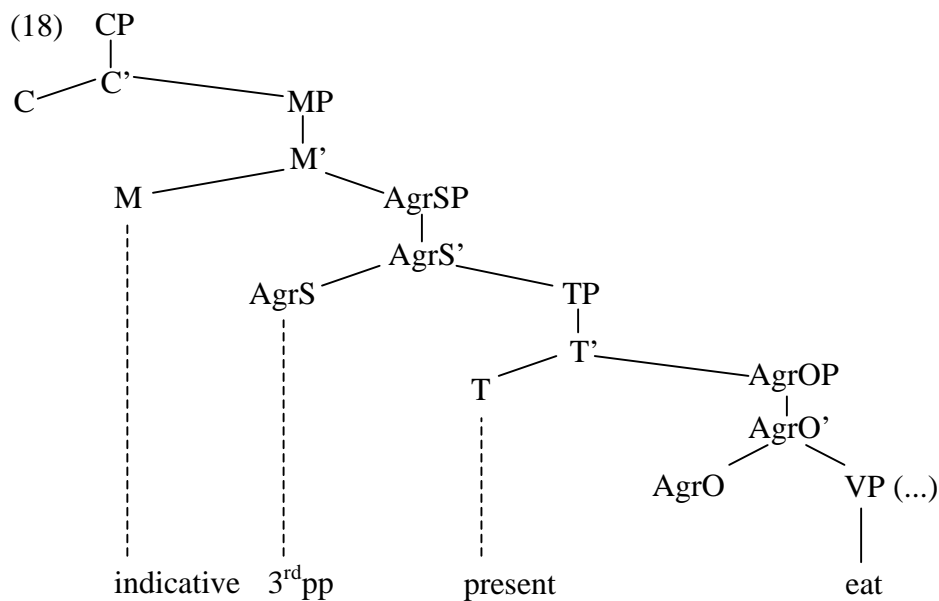

Besides, some changes have been introduced under the minimalist approach in the tree diagram in (17): the elimination of AgrS, the elimination of AgrO as external to V, the subsequent introduction of the "light" verb *v* and the presence of

two specifiers for some of the heads.²³

Thus, once *select* and *merge* apply, the structure is built. The next step is *move* or, as Chomsky maintains, the "displacement property"; both terms refer to the same phenomenon.²⁴ However, before dealing with movement operations, we will refer to certain conditions that must hold up when these operations take place.

1.2.2.2. The Principles

Movement is triggered by the need of lexical items to check their features in functional categories. However, in order for a computation to be optimal, it has to follow economy principles which constrain movement in order to minimize derivation.²⁵ The main idea is that derivations must be as economical as possible without any superfluous or redundant steps.²⁶ This movement towards minimizing the steps is captured by the principles of economy. The three main principles of economy considered in the MP are the following:

1. Minimal link condition (previously called shortest *move*).²⁷ This principle deals with the length of the derivation. Chomsky (1995) defines it in the following words: "a longer link from α to K cannot be formed if there is a shorter legitimate link from β to K" (295), so that, " α can raise to target K only if there is no legitimate operation *move* β targeting K, where β is closer to K" (296). The

²³ This will all be discussed later, having as a starting point Pollock's (1989) split inflection hypothesis, together with other developments in the theory in order to provide a coherent background for the analysis of subjects carried out in chapters two and three.

²⁴ Items appear in positions displaced from those in which they are interpreted. The displacement property clearly reflects the disparity --in fact complementarity-- between morphology (checking of features) and theta-theory (assignment of thematic roles), something which is stressed more and more in the MP.

²⁵ Even though Chomsky considers both *select* and *merge* irrelevant with regards to economy concerns and states that only *move* is constrained by them, it is necessary to add that Kitahara (1995) applies economy principles not only to *move* but also to *merge*.

²⁶ As we will see in due course, such steps are actually blocked by the principle of full interpretation (FI).

application of this principle involves a global comparison of possible different derivations, instead of a local application of a principle at one point in a derivation.²⁸

2. Procrastination. This principle states that, since overt movement is more costly than covert movement, the former should operate as late as possible.²⁹ The idea is that, while reaching to PF, structures try to minimize overt syntax, thereby making use of feature checking (covert movement) whenever possible, rather than applying overt movement before Spell-Out.³⁰

3. Last resort, (previously called greed).³¹ According to this principle, when a constituent moves, it does so in order to satisfy its own needs. If there are no requirements to fulfil, there must be no movement, since movement is nothing short of a last resort. As Marantz (1995) puts it, this principle implies the exhaustion of other possible resorts a derivation may have for avoiding the violation of some principle or filter. Therefore, this last economy principle bans, for example, super-raising, as illustrated in (19):

(19) *John_i seems [that [IT is certain [t_i to fix the car]]]

²⁷ We will always refer to the last version of the principles of economy.

²⁸ According to Marantz (1995), the minimal link condition includes a reflection and rephrasing of previous constraints labeled subjacency, Rizzi's relativized minimality and the head movement constraint. For varying approaches see, among others, Huang (1982), Lasnik and Saito (1984), Rizzi (1990), Watanabe (1991, 1992a) and Chomsky (1995).

²⁹ This economy principle proposed by Chomsky in the MP contrasts sharply with the opposite principle proposed by Pesetsky (1989) and Pollock (1993) which they call the earliness principle. Following the earliness principle, one should move as early as possible, before Spell-Out if possible rather than after it. We will not pursue this issue any further since it completely departs from the general trend of the minimalist principles of economy. For further reference see Brody (1993).

³⁰ Notice that if the overt-covert distinction collapses (Chomsky 1998, 1999), procrastinate is not formulable. Therefore, Pesetsky's (1989) earliness principle (perform computations as quickly as possible) would be applicable.

³¹ As we will see in due course, Lasnik (1995) proposes a weak version of greed which he calls enlightened self-interest principle.

In (19), the subject NP John undergoes super-raising from its original position in the embedded clause (to fix) to the subject position of the main clause (seems), past the position where the subject of is (it) is placed.

The use of economy principles leads to an implicit comparison of derivations in the sense that we always have to look for the most economic derivation in terms of length, cost and requirements, respectively. This may also be related to a comparison of derivations not only within a language, but also among different languages. This implies that when comparing different constructions in various languages, we should indicate which one is more economical.

The last requirement for a derivation to be optimal is to comply with checking theory. Checking theory regulates, by means of movement operations, the optimal matching of interpretable and uninterpretable features: interpretable features are the ones lexical items have, while uninterpretable features are those contained in nodes such as IP. Items come fully inflected from the lexicon. Therefore, checking relations are created by movement only and not by *merge*. The checking process is carried out in the following way. The item (and its features) is affected by checking theory in such a way that it confronts the corresponding abstract features in inflection (I) and ν . Therefore, the information contained in I and ν is no longer in the form of affixes that attach to items, as it was in previous models; it is rather a collection of features that must coincide with the features of the item. If the features of the item and of I/ ν match, then I and ν disappear and the derivation enters the PF component under Spell-Out. If the features do not match, then I and ν remain and the derivation crashes at LF.

In a sentence like the one in (20), for example, the head of the VP, the verb escribe, has to check its features (present tense, 3rdps) in ν and I. In this way, the

features contained in v and I have to be [present tense, 3rdps] as well, for the derivation not to crash. In order to check such features, the features in V raise to v and then to I. So it is not the entire verb that moves, but rather just the features that need to be checked, as indicated in (21a) and (21b). Here lies the difference between alpha-move (movement of categories) and F-move (movement of features), which is intimately related to the economy principle of procrastination.

(20) Marta escribe una carta

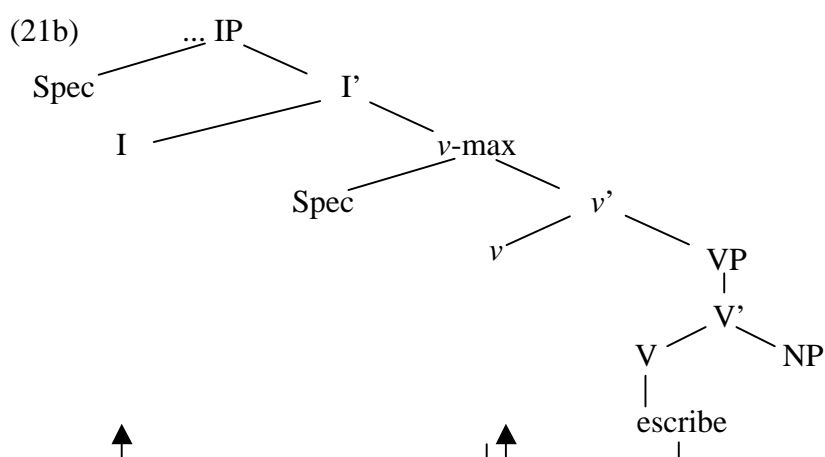
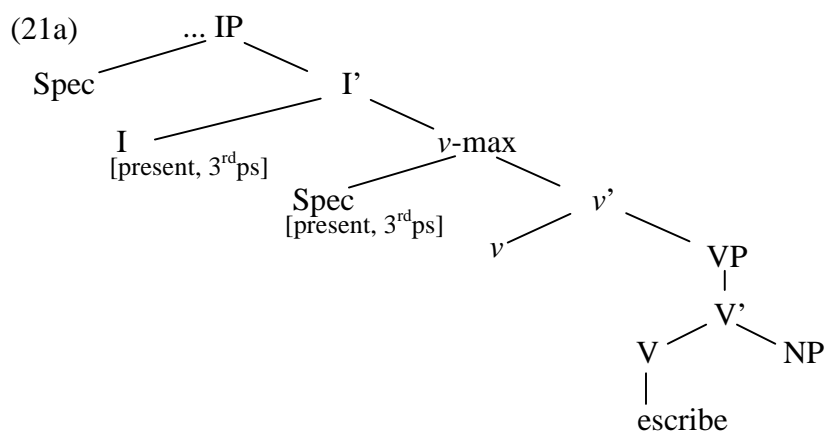

The same process affects the English sentence in (22):

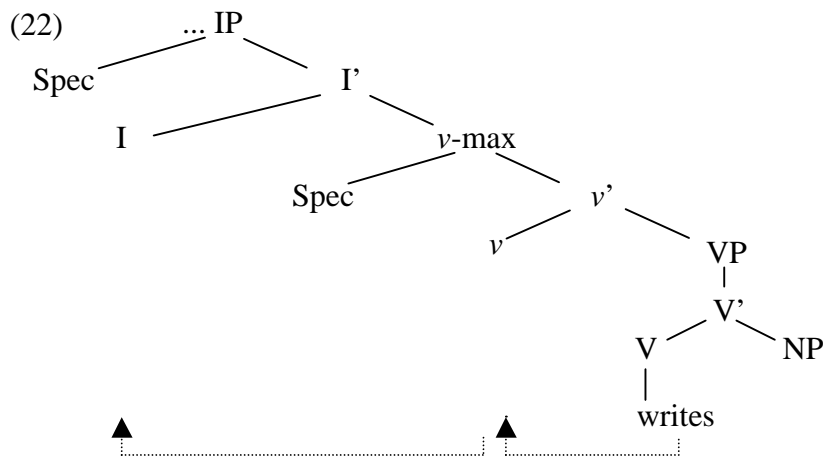

The verb writes comes with the feature -s incorporated. As in the previous case, if there is any pairing of [present tense, 3rdps] features between V and I/v, then these features in I, once checked, disappear and the derivation is legitimate. If, on the contrary, the features do not coincide, v and I are not deleted and, as they are not legitimate LF objects, the derivation crashes. This is the minimalist approach to the building of well-formed constructions which contrasts with previous approaches based on the movement of entire categories and subsequent cyclic movements to pick up all affixes (the 3rdps -s in the present tense in English) necessary to complete the bare-item (write). With the reduction of operations and the straightforwardness achieved by the MP, all processes have been simplified.

Under the minimalist maxim of getting rid of unnecessary levels, some nodes in the tree diagram, as seen in (17), (Tense and specially AgrS and AgrO contained within IP) are to be re-defined together with the information these nodes were supposed to contain. This will give way to a new organization in the tree diagram as it is partially indicated in (17), which will be dealt with later.

Both Tense and Agreement nodes were considered to be affixes, an analysis

reflected in Emonds (1980), Pollock (1989, 1993) and Chomsky (1991), among others. That is why Pollock's (1989) proposal deals with the raising of verbs to Tense to get the affix or the lowering of the affix in Tense to mix with the verb (what was previously called affix-hopping). Nevertheless, the minimalist approach presents a new approach to movement which, as we have already said, is very different from the approach to movement in the PP approach. The information present in layers such as I and v is not considered an affix but rather an abstract feature. In this way, lexical items come fully inflected from the lexicon and their features are checked with the abstract features contained in those nodes according to checking theory. Therefore, Agreement plays only a mediating role and the same is true of Tense, when they have performed their role, they disappear.

The minimalist reformulation not only affects the information that is internal to those nodes but also to the nodes themselves. Nevertheless, going back to Chomsky's (1991) split of AgrP, we are to consider AgrS and AgrO as informal notations in order to distinguish the two functional roles of Agreement: subject-verb agreement (associated with nominative Case and determined by the relation of [Spec VP] to AgrS) and object-verb agreement (associated with accusative Case and determined by the relation of the NP to AgrO). In this way, we are in fact talking only about one element, Agreement, as a collection of phi-features. Under minimalist assumptions, Agreement has no semantic properties of any kind (since every item comes fully inflected from the lexicon), although it is structurally motivated since a position is needed to check the subject/object either overtly or covertly, among other issues.

The new position for AgrO is to be found in a reformulation of the VP which is now made up of two layers: the upper layer (small v or "light" verb) would

correspond to the previous AgrO.³² As opposed to AgrO, the "light" verb *v* is required on the basis of structure since it has lexical content.³³ Also, while AgrO was outside the VP, *v*, as shown in the tree diagram in (17), which we partially repeat here in (23), is included in the VP and thus movement is kept within the VP (no more concepts of domain or barriers or equidistance intervene, and consequently no violation of any economy principle occurs):

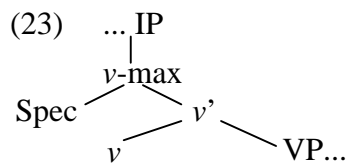

As far as AgrS is concerned, it blends with Tense (Inflection), a category with meaning, so that it will be in this node where nominative Case as well as Tense are to be checked. In this new reorganization of Agreement nodes, another important modification is the possibility of having more than one specifier per head.³⁴ This is clearly seen in the tree diagram in (24), where both I and *v*-max are equipped with two specifier positions each:

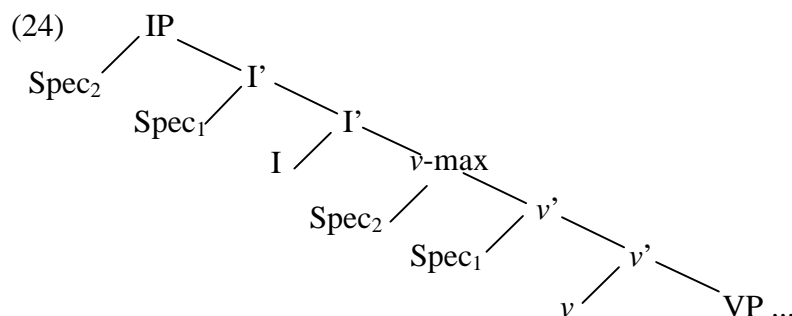

³² Some of the ideas behind this proposal also underlie Chomsky's (1995) analysis of multiple specifiers. Hale and Keyser (1991, 1993) and Speas (1986) propose the two-VP-layers analysis.

³³ Larson's (1988) proposal.

³⁴ As we will see later, this new minimalist analysis which allows the presence of more than one specifier will have consequences for the analysis of there constructions, as constructions with a so-called double subject.

Each of these double positions constitutes a slot in which both subject and object will rise to check their features, the inner Spec (Spec₁) for the subject and the outer Spec (Spec₂) for the object. That is why, as Chomsky (1995) maintains, the entire transition from one proposal to the other can be summed up by saying that "the main change is a change from Agr-based to a multiple-Spec theory" (355) because the roles these Specs play corresponds, in fact, to the one played by AgrS/O.

Pollock's (1989) split inflection hypothesis has helped to point out the necessary distinction among the different features contained in I. Once this split has been accepted and analyzed, a reorganization of such features has led to a more accurate perception of how sentences are built. And even if Pollock's (1989) proposal is not followed word for word, the idea behind it is still maintained: the importance of the split of the features constituting the node I for the comparison among languages, specifically between English-type languages and French-type languages. When confronting a comparative analysis, these individual features are going to provide ground for parametric differences among the languages under analysis, as we will see throughout the corpus of this work.

Once the processes of *select*, *project* and *merge* have occurred, movement takes place. Words are fully inflected when they are taken from the lexicon. Variation among languages has to be attributed to differences between the features of lexical items in those languages; and these are the features that need to be checked through movement. In the minimalist framework syntactic structures are built step by step, starting from the lexical projection and extending the projection upwards by means of functional projections.

(25) a. we sing a song

b. *pro* cantamos una canción

c. nous chantons une chanson

Thus, in sentences like those in (25), we select from the lexicon a fully inflected verb, sing/cantamos/chantons (with all its inflectional endings), which projects a V' with an empty complement position. This position is filled by the object, a song/una canción/une chanson, through *merge*. The three examples in (25) differ at least with regards to these three issues: covert movement in English (25a) *versus* overt movement in Spanish/French (25b, 25c); the extent of the movement (verbs remaining in *v*-max in English (25a) while moving to IP in Spanish (25b)); and the slots present or lacking in every language depending on whether or not they are filled (AgrOP present in French (25c), but neither in English nor in Spanish).³⁵

The first checking relation that is established is the movement of V to *v*, the "light" verb, and from *v* to I. Such movement may be covert, as in the English example in (25a) and the corresponding tree diagram in (26), which means that it takes place after Spell-Out and that it is just a movement of features; the category itself does not move, the features raise alone:

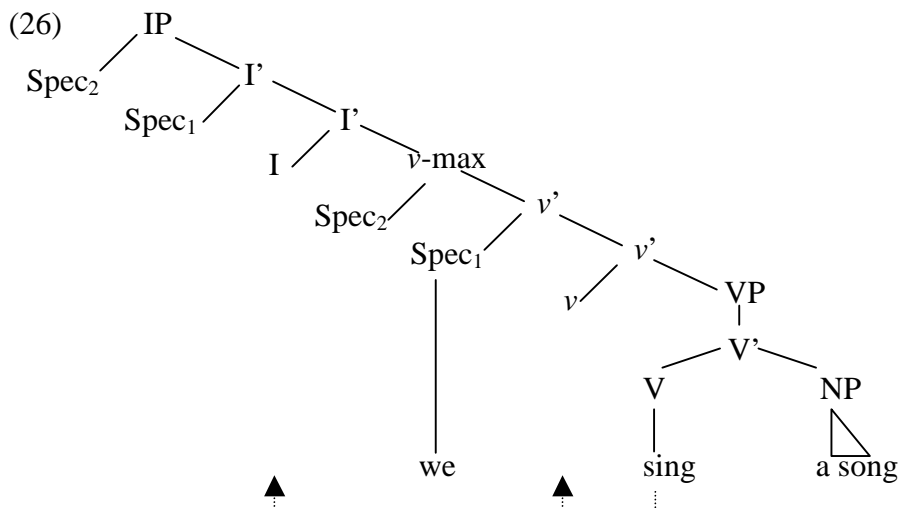

Since the V-features are weak in English, there is no need for the verb to raise and check them before Spell-Out (thus complying with the economy principle of Procrastinate).

This movement may be overt as in the Spanish and French examples in (25b) and (25c) and the corresponding tree diagram in (27):

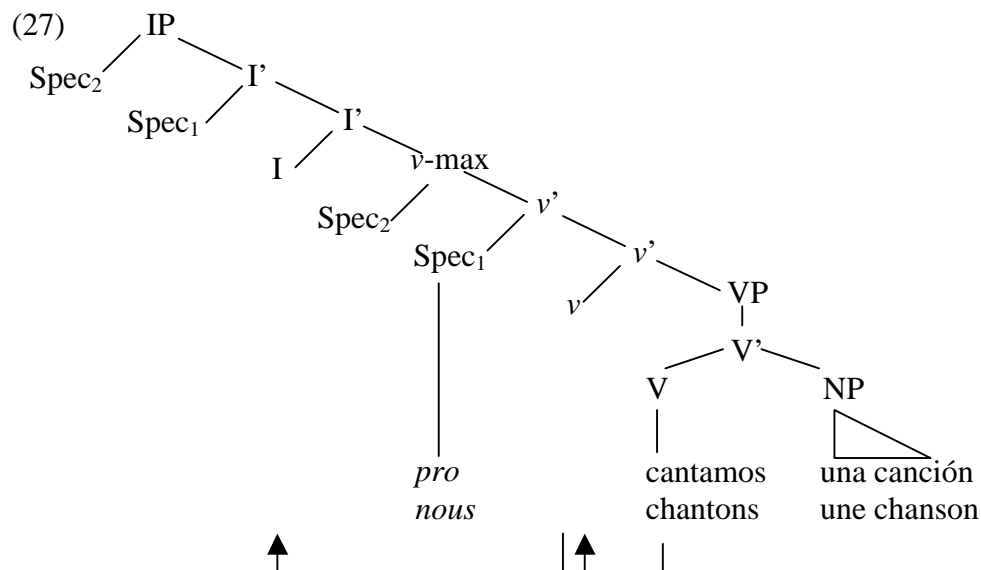

As an overt movement, it takes place before Spell-Out and the movement carries along a full category with the subsequent formation of an argument chain (A-chain), since it is a movement from an argument position (V) to another argument position (*v* and then I).

The second checking relation affects the subject NP that moves from [Spec₁ v'] to [Spec₁ I], as in (28):

³⁵ There is no entity in the MP consisting of any position that is projected but not filled, although a position could very well be filled by an empty category, such as *pro* (in [Spec₁ IP]).

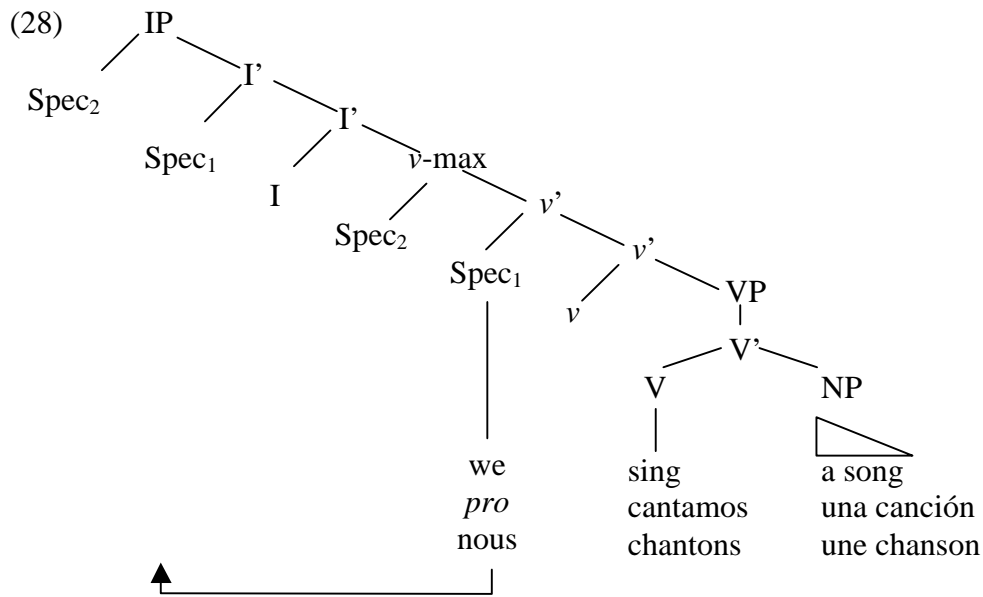

The subject has nominative Case from the lexicon which will be checked by the N-features of I in Spec₁. This movement is always overt. Even when we deal with a pro-drop language such as Spanish, *pro* also raises to [Spec₁ I].

The last checking relation in the examples in (25) deals with the object. The object has accusative Case from the lexicon which will be checked by the N-features of I in Spec₂. Again the movement may be overt or covert, depending on the language, but in both cases the object moves from its original position as sister to V. It undergoes a double movement, first to [Spec₂ v-max], and then to [Spec₂ I], as shown in (29):

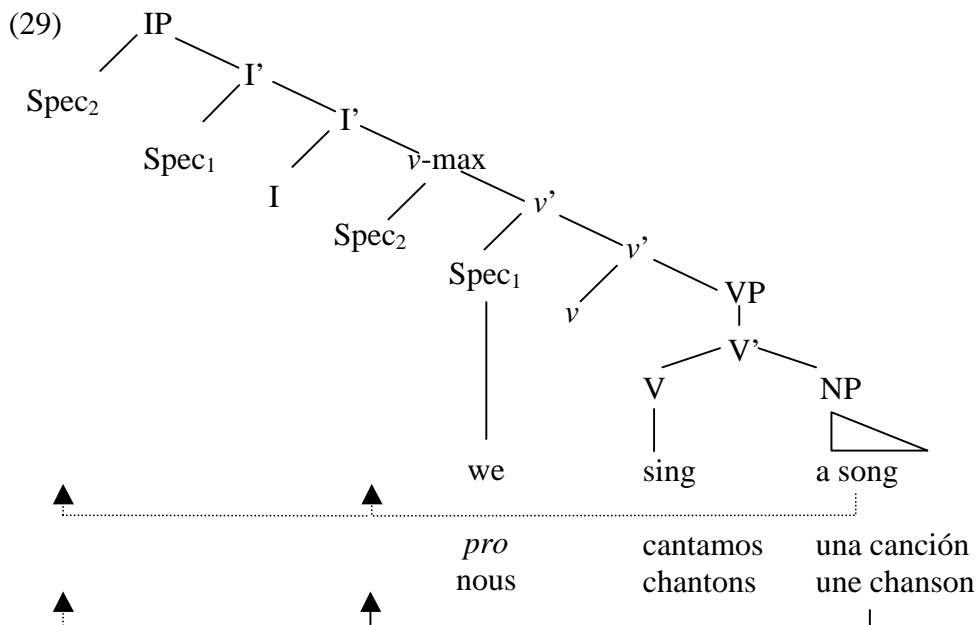

Since v , heading the transitive verb construction, is [-strong] in English, object movement is covert. In Spanish and French, on the contrary, v is [+ strong], therefore object movement from NP to [Spec₂ v -max] is overt. The reason for the covert object movement from [Spec₂ v -max] to [Spec₂ I] is to be found in the effects of subject movement, as the tree in (30) shows, in which both movement and traces are indicated:

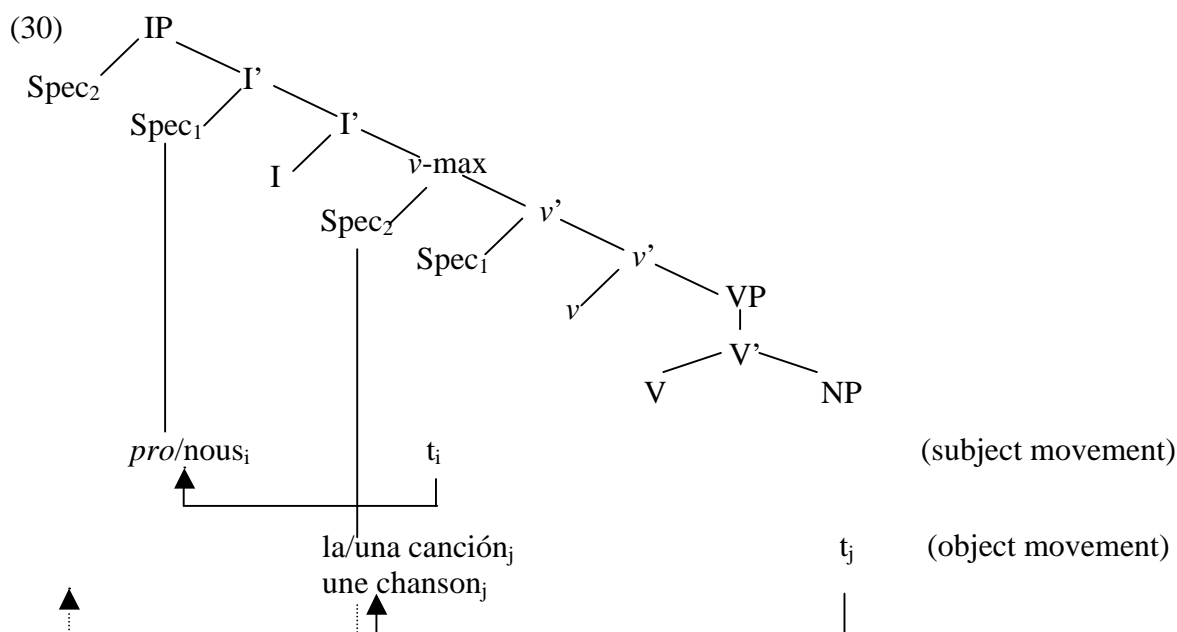

In English, both parts of object movement are covert so that the lexical item a song remains in its original position after *merge*. The trace of the subject in [Spec₁ v -max] does not prevent the overt raising of the object to [Spec₂ v -max], but the subject itself placed in [Spec₁ I] does block the overt raising of the object to [Spec₂ I] so that this raising operation has to be covert.

Therefore, we can say that the significant parametric differences between languages are limited to lexical differences, specifically to differences in the features of lexical elements. These features may be either weak -invisible at PF

even if unchecked, such as verbal features in English-, or strong -visible at PF if unchecked, such as verbal features in Spanish-.

According to Marantz (1995), we can conclude that the major changes in the development towards the MP are the following: a) constituents move for a reason, not arbitrarily; b) "grammaticality" depends on a comparison of derivations, not on the evaluation of a particular derivation in isolation; c) principles apply only at the interface levels of PF and LF or everywhere -DS and SS do not figure in the system-.

Also, the basic idea that permeates all operations in the entire program is that of economy, as has been previously indicated. Only the most economical derivation yields a grammatical sentence.

To sum up, two of the basic assumptions in the MP are: a) the proposal that parametric variation among languages should be reduced to morphological properties (abstract features) of lexical items; b) the proposal that movement in the overt syntax should not be legitimate unless necessary for convergence, optional movement being thus eliminated from overt syntax.³⁶

1.2.2.3. Optionality of Movement in the Minimalist Program

After the presentation of the principles that affect movement, a few more words need to be said about movement and optionality within the MP. By restricting the use of *move*, one maximizes the optimality of the computational system. Movement in the MP is only driven by morphological requirements

³⁶ On overt movement, see Lasnik (1999).

(features) and has to be motivated. Therefore, and as has been explained in the previous section, syntactic movement is never optional.³⁷

From these premises, the situation of movement in the MP is as in diagram (IV), following Olarrea (1996):

Diagram IV

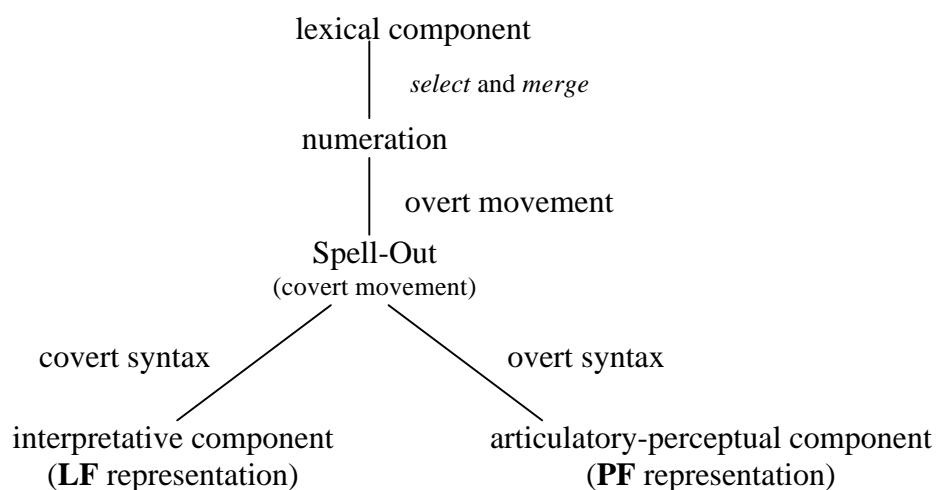

A numeration is an item or a sequence of items taken from the lexicon. It indicates the lexical choices available and the number of occurrences of these items so that *select* and *move* operations can apply and build a derivation.³⁸ As stated in previous sections, Spell-Out constitutes the point in which the derivation divides into two in order to create representations at the two minimalist levels (LF and PF). Spell-Out also establishes the division line between, on the one hand, overt movement that involves movement of categories and that takes place before Spell-Out, and, on the other hand, covert movement that is always adjunction of the formal features of a

³⁷ Chomsky (1999) deals with optional operations and he defends that these can apply only if they have an effect on the outcome. This view has OT overtones, in the sense that the non-optionality maxim can actually be violated provided the necessary conditions are met.

³⁸ Using Chomsky's (1995) definition, "a numeration is a set of pairs (LI, i) where LI is an item of the lexicon and i is its index, understood to be the number of times the LI is selected" (225).

category F to a head H and takes place after Spell-Out.³⁹ While the effects of overt movement are visible at both PF and LF levels, the effects of covert movement are only represented at LF and affect the interpretative component. This means that after Spell-Out, overt syntax applies at PF and covert movement at LF.

The concept of movement is, therefore, tied to Spell-Out (Spell-Out in its turn being associated with Agreement). In the MP, Spell-Out applies at a single point in a derivation. This way of perceiving Spell-Out poses a problem for cases such as expletives, for example, as we will see later. Pre Spell-Out, the features of the item must be deleted when checked. There in expletive constructions is seen as a “deleted” feature, since it has no meaning and is, therefore, invisible at LF; yet there remains until Spell-Out and is accessible to the phonetic component. In view of these facts, Chomsky (1998) re-analyses Spell-Out. He defends that Spell-Out applies cyclically in the course of the derivation: the deleted features are literally erased, but only after they are sent to the phonetic component along with the rest of the structure. Hence, for instance, if the EPP is to be satisfied in English, an item in subject position is required in PF; in the case of expletives, there remains in PF to fulfill this function.

The single Spell-Out thesis of the MP retains the flavor of the extended standard theory model and the GB model, thereby distinguishing overt from covert operations (pre and post Spell-Out respectively). The MI approach defends that all operations (both overt and covert) are cyclic.

As pointed out by Olarrea (1996), optionality of syntactic movement poses several problems. In fact, one of the basic assumptions in the PP framework was that the application of alpha-move was optional; this rule constrained the output of

³⁹ As we will see in the following section, this division of overt-covert movement before/after Spell-

its application by a set of representational constraints that applied at the relevant levels of representation. In the MP, on the other hand, syntactic movement is never optional, but legitimate only if necessary for convergence and forced by the presence of specific morphological features.

As a major consequence of all this for our analysis, we can say that the phenomenon of free subject inversion that characterizes null-subject languages like Spanish, and whose explanation has been traditionally based on the notion of optionality of movement, presents a problem for a minimalist account.⁴⁰ As we will see later, Olarrea (1996) proposes that the problem of optionality of movement specifically related to free subject inversion in pro-drop languages can be solved once we assume that sentences with preverbal subjects and sentences in which the subject appears in postverbal positions are the result of two different numerations. As we will see in the following chapter, taking as a starting point the idea that postverbal subject position must always be filled, an SV derivation presents both an NP in preverbal subject position and a *pro* in postverbal subject position; both NP and *pro* share the same morphological features. A convergent SV derivation is the most economical output of a numeration that presents both a *pro* and a noun (and therefore an NP); this empty pronominal is absent in a numeration whose output will result in a VS ordering in which the postverbal subject is lexical.

The main idea is that since optionality of movement is no longer applicable under minimalist premises, word-order differences must be located in the different selection of the lexical items involved, that is, before movement operations apply.

Out will change since Spell-Out is now seen as cyclic (Chomsky 1998, 1999).

⁴⁰ As Olarrea (1996) states, there is another issue related to the problem of optionality of syntactic movement that must be mentioned. When dealing with the contrast between preverbal and postverbal subject positions in Spanish, i.e. on the basic differences between SV and VS orders, it is

1.2.2.4. Subject-verb Agreement as a Movement Operation in the Minimalist Program

Let us exemplify how movement takes place under the MP by looking at the operations involved in the agreement phenomenon between subjects and verbs, a movement that is driven by morphological requirements and is motivated.

As Olarrea (1996) describes, subject-verb agreement within the MP could be summed up as follows. The subject raises from its base-generated position to [Spec AgrSP], as in (31):⁴¹

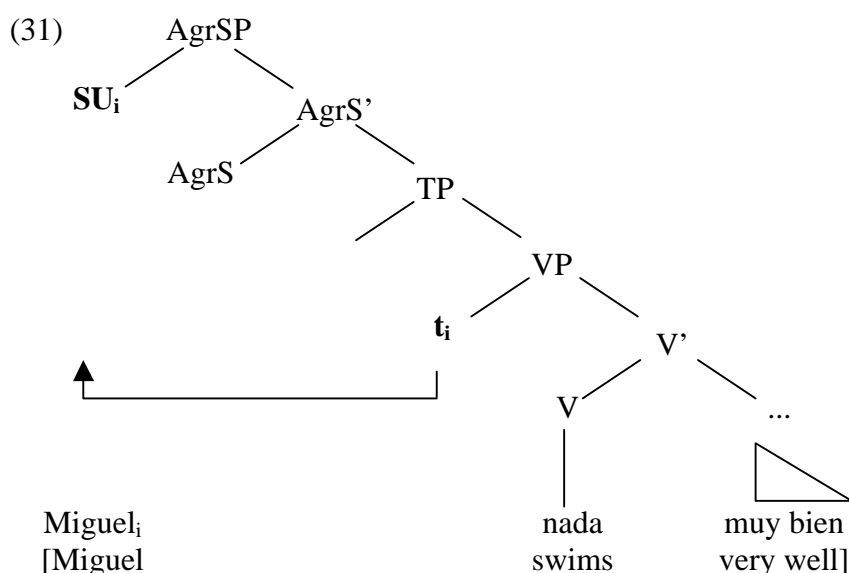

The verbal head raises to adjoin to the AgrS head via cyclic adjunction to the intermediate functional heads, a movement that counts as a single complex operation, as in (32):

necessary to keep in mind that Spanish presents two different VS orders: VSO and VOS. We will deal with this issue in the next chapter.

⁴¹ As we said before, AgrS, AgrO and Tense are dispensed with in the MP. These nodes have no semantic properties since all items come fully inflected from the lexicon. Nevertheless, in terms of

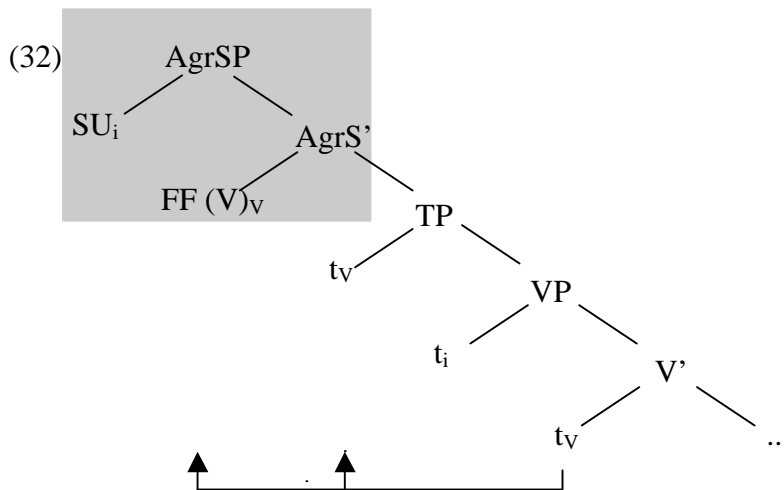

As a result of these two movement operations, both the verb and the subject are in the checking domain of AgrS and can match (delete or erase) their features against the appropriate features of this functional head. When the features of both verbal head and subject match the AgrS features, agreement obtains and the derivation converges.

As has been previously shown, transitive V in languages such as French includes object features that must be confronted in the corresponding AgrO node (nous l'avons chantée -la chanson-).⁴² Such an overt V-O agreement is neither present in English nor in Spanish; but V-O agreement does constitute a necessary operation (though with no bearings on PF) for the verb to check all its features. The following tree in (33) includes all checking relations undergone by V (subject, object and T features) and how all of them meet in AgrS:

structure, the positions are maintained within IP because subject and object features have to be checked. Here we use the nodes for methodological purposes to show movement operations.

⁴² For a detailed analysis of participle agreement in a variety of Romance languages, see Kayne (1985, 1989). See also Suñer (1987) for Spanish.

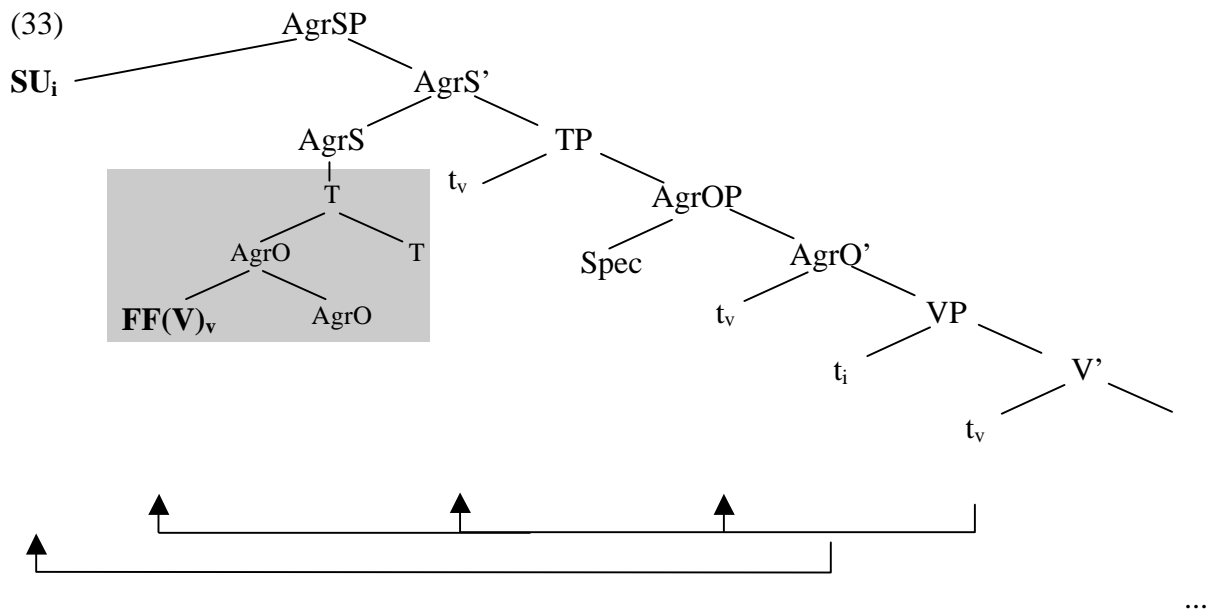

Subject-verb agreement therefore consists of a complex and single operation, as reflected in (33), with all verbal features FF (V) in AgrS. The different steps are as follows: the verbal features FF (V) adjoin to AgrO and leave a trace t_v in its original position. Thus the following chain is formed, in which CH_v stands for verbal chain: $CH_v = [FF(V), t_v]$. Once raised, FF (V) in the tree has no checking domain, but the chain CH_v that is headed by FF (V) does. The complex FF ([V, AgrO]) raises to T to check its V-related features and then raises to adjoin AgrS for the same reason. Neither V nor CH_v have a new checking domain in this adjoined position, but FF (V), as part of the complex FF ([V, AgrO, T]), is now in the checking domain of AgrS and shares features with it. The different steps for FF (V) are illustrated in the following bracketings in (34):

- (34) the chain: $[FF(V), t_v]$ in AgrO
 the final chain: $[AgrS FF(V)_V [TP t_v [AgrO t_v [VP t_v]]]]$
 the complex: $FF [V, AgrO]$

FF [V, AgrO, T] in [Spec TP]

FF [V, AgrO, T, AgrS] in [Spec AgrS]

The tree will then be as in (35):

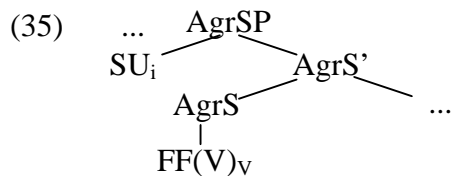

Since the NP-subject has raised overtly to [Spec AgrSP], the subject SU is also in the checking domain of the head AgrS. Even though this overt movement was the result of attraction by the nominal feature in AgrS, the rest of the formal features of the subject have also raised as free riders. Among these free riders are the agreement features of the subject, and they can now match indirectly with FF (V) in the checking domain of AgrS. Subject-verb agreement is therefore formally explained.

At the same time, the subject in [Spec AgrSP] is in the checking domain of AgrS and in the checking domain of the chain headed by T. As a consequence, it will check not only agreement but also Case features.

When taking the movement of the object into consideration, a question arises: what prevents the arguments of the verb from raising to the specifiers of the inappropriate Agreement projections, i.e. for the object to raise to [Spec AgrSP] and for the subject to raise to [Spec AgrOP], thereby rendering an ungrammatical structure like the one in (36)?:

(36) by Spell-Out: *[[AgrSP apples_i] [VP John [V_vate t_i]]]

In response to the question regarding why the object could not raise to [Spec AgrSP], checking Nominative features, and the subject to [Spec AgrOP], checking Accusative features, Chomsky's (1992, 1993) solution derives from the application of a new economy principle, the minimal link condition, the locality condition that restricts movement to the shortest move.

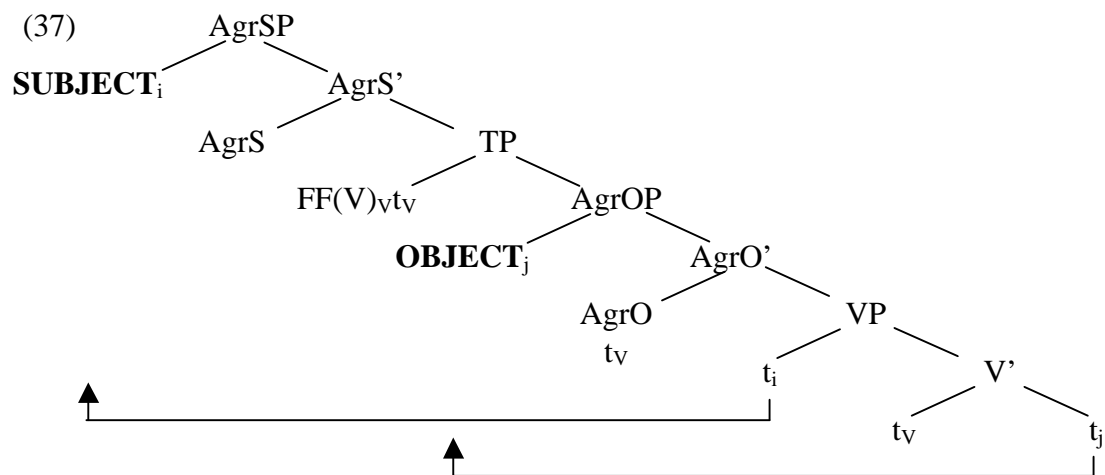

As previously stated, the relevant condition that favors shorter moves over longer ones is known as the principle of shortest movement. Since the effect of the principle is to favor the formation of movement chains with minimal links, i.e. the smallest shortest possible links, the relevant principle is also referred to as the minimal link condition or the minimality condition (Chomsky 1995). This includes Rizzi's (1990) relativized minimality principle by means of which a moved constituent moves to the nearest appropriate position; thus, depending on the type of constituent being moved, the appropriate position will vary. For instance, a moved head will move to the next-highest head position (head movement); an argument will move to the next-highest A position (A-movement); and an operator will move to the next-highest operator position (A-bar movement).

On the one hand, if the subject were to rise to AgrO, as in (38), it would have to receive accusative Case and object agreement:

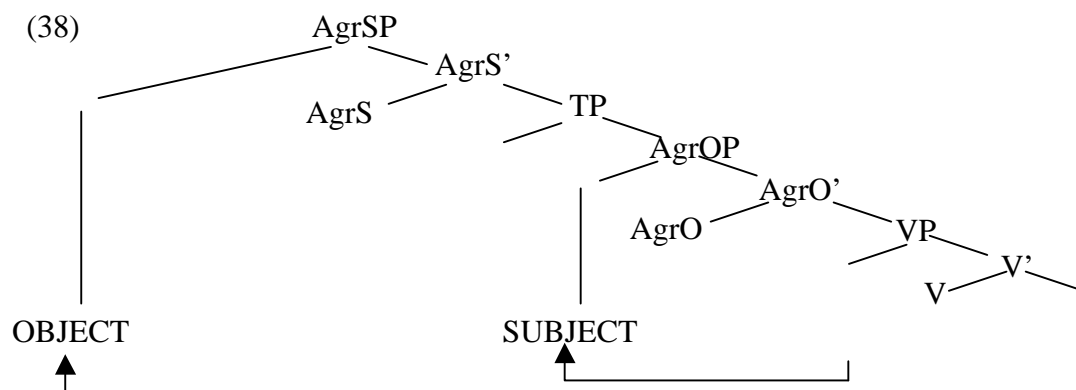

The object, on its turn, also has to check its Case, presumably in [Spec AgrS], but the object cannot reach that position since the subject in AgrO is blocking that raising.

As the previous tree diagram in (37) shows, when the subject moves to [Spec AgrS] leaving a trace in [Spec VP], object movement to [Spec AgrO] is not blocked, since the trace of the subject in [Spec VP] is invisible to *move* (contrary to the subject itself that does prevent the raising of the object).

On the other hand, we see in (33) that in the MP, T does not project a specifier position in the case of languages such as Spanish. The checking of nominative Case occurs then at the point of derivation in which the complex head created by adjunction of V to T raises to adjoin to AgrS, rendering a configuration in which the element in [Spec AgrS] is in the checking domain of all the heads within the complex AgrS, i.e. [V, T, AgrS].

Also direct movement of the subject to [Spec AgrSP] when [Spec TP] is present would violate relativized minimality since it would cross two specifier positions, [Spec AgrOP] and [Spec TP].⁴³

Summing up the theoretical background provided by the PP theory and the MP, certain contrasting points between the two approaches need to be stressed:

- a) As opposed to the PP theory, in the MP a derivation that satisfies all interface constraints does not necessarily yield a grammatical sentence. Economy conditions have to apply.
- b) The change in paradigm from the PP theory to the MP research program involves also a change from a representational to a derivational model of grammar since under a minimalist perspective a sentence not only must be assigned a well-formed representation but also has to comply with economy principles at any point in the derivation.
- c) In the MP, *merge* theory specifies possible projections of head-complement, head-specifier and adjunction structures. It replaces X-bar theory in previous models.⁴⁴
- d) Unlike it is the case in the PP model, in the MP functional heads do not represent agreement morphemes of a particular language, but rather a collection of abstract morphological features that must be checked.

Within the generative framework, two different approaches have recently been proposed. Both are based on minimalist assumptions, but provide some points of departure from the MP in an attempt to better capture certain differences and

⁴³ Nevertheless, as Olarrea (1996) points out, the result seems to be necessary only for languages with covert V-to-I movement and obligatory subject raising. Adjunction of the verb to T and subsequent adjunction of the complex head to AgrS will allow cyclic movement of the subject to [Spec AgrSP] through [Spec TP].

⁴⁴ See Chomsky (1995).

similarities between languages. The two proposals are Kayne's (1994) antisymmetry which focuses on word order, and Archangeli and Langendoen's (1997) optimality theory which concentrates on different rankings of constraints. In spite of their differences, both antisymmetry and optimality aim at providing a more refined account of how differences among languages are to be explained; and how these differences are interrelated and explained in terms of UG. We will deal with each theory separately.

1.3. Antisymmetry

1.3.1. Introduction

The antisymmetry approach proposed by Kayne (1994) constitutes a highly constrained theory of word order. Under the standard assumption, UG allows a given hierarchical representation to be associated with more than one linear order. Antisymmetry, on the contrary, makes unavailable certain widely-assumed mechanisms of analysis such as right adjunction and multiple adjunction to the same head. In that sense, it implies a restriction of the previous theory. Thus, word order and adjunction are going to be fundamental dimensions in the antisymmetry approach which are also relevant to our analysis.

1.3.2. The Relationship between Hierarchy and Linear Order

As Ordóñez (1997) states, the core of antisymmetry is the unification of the two fundamental dimensions of syntax: hierarchical structure and linear ordering of the constituents of a sentence. As a consequence, antisymmetry is more restrictive than previous approaches to syntactic analysis in terms of the theoretical apparatus

allowed. Evidently, this reduction in available mechanisms is a potentially important advancement because it represents a more restrictive syntactic theory.

As Kayne (1994) states, hierarchical relations have traditionally been encoded under the X'-schema in (39):

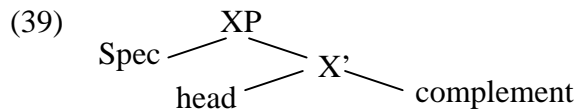

On the other hand, the order in which constituents appear has been considered to be a product of language-specific grammars, as reflected in (40a) and (40b) for English and Japanese, respectively:

- (40) a. from Tokyo a'. Sandra hit Mary
 b. Tokyo kara b'. Sandra-ga Mary-o but-ta
 [Tokyo from] [Sandra-subject Mary-object hit-past]

Both in the case of phrases and sentences, word order was considered language-specific. Cases such as the ones in (40) were accounted for in terms of the directionality parameter or the head parameter (Travis 1989) which opposed languages such as English or Spanish to Japanese.

Given such variations, it has traditionally been assumed that the hierarchical arrangement between head and complement can have two symmetrical linear realizations; that is, the head may precede the complement, as in English (therefore, a head-initial language), or it can follow the complement, as in Japanese (therefore, a head-final language):

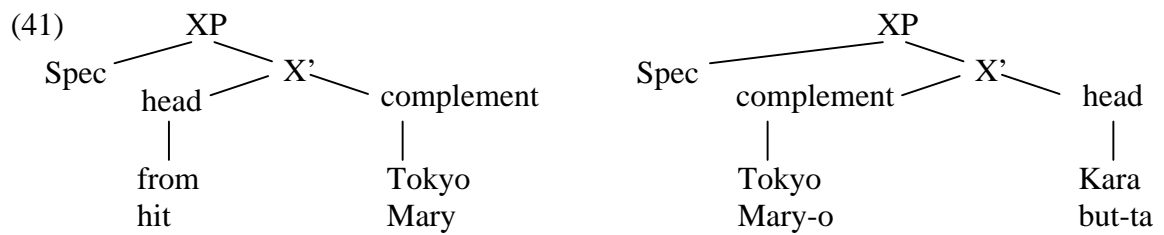

Separate treatments of constituent order and hierarchical structure like this one have been a constant in generative linguistics, with the notions of universals and parameters of variation always in mind (Chomsky 1986).

According to Kayne (1994), this way of conceiving UG is too permissive.⁴⁵ He argues that, in spite of superficial appearances, the relationship between linear order and hierarchical structure is rigid. The only order in human language is the one where the specifier precedes the head, and the head precedes the complement, as in (39) repeated here as (42):

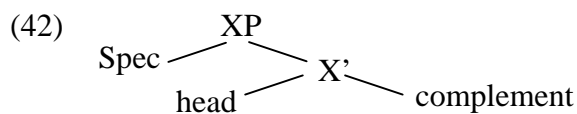

In that sense, asymmetric c-command always implies precedence, as opposed to subsequence.

This idea of precedence is key in the antisymmetry analysis. Kayne (1994) defends the existence of a mapping between hierarchical structure and the observed linear order that is rigid. He refers to this mapping as the linear correspondence axiom (LCA), stated in (43):

(43) linear correspondence axiom (LCA): $d(A)$ is a linear ordering of T ⁴⁶

The function of this axiom is to map the different hierarchical relations established between specifier, head, and complement into the corresponding linear order. Assuming that the universal order is Spec-head-complement, there is a redundancy between hierarchical relationships and linear order. Thus, there is a need to find a hierarchical relationship with similar properties of linear order. Such a relationship must be antisymmetrical, transitive and total.

As Ordóñez (1997) explains, the relationship between hierarchy and linearity is mediated by a trivial mapping from non terminal nodes (A), which are the ones relevant for hierarchical relations, to the corresponding terminal nodes (T), the relevant nodes for linearization. This mapping is called $d(X)$. Kayne (1994) postulates that for any given non terminal node A which enters into asymmetric c-command with another non terminal node B, there will be a mapping into precedence of the terminals dominated by a non terminal node A with respect to the terminals dominated by the non terminal B.⁴⁷ The mapping must necessarily cover all the non terminal nodes in a given phrase marker.

Along the lines of Kayne (1994), Ordóñez (1997) analyzes the nature of specifiers and adjunctions within antisymmetry. Phrase structure only considers heads (non-terminals immediately dominating a terminal), maximal categories (non-terminals dominating another non-terminal), and segments of maximal projections and heads. But since the status of intermediate category is eliminated, the formal differences between specifiers and adjuncts are also eliminated.⁴⁸

⁴⁵ See Ordóñez (1997) for the four different possibilities allowed.

⁴⁶ Where T is a set of terminals and (A) are pairs of non-terminal nodes (Kayne, 1994).

⁴⁷ This is only a partial answer as to why the order has to be Spec-head-complement. Nothing bars the possibility of the mapping from asymmetric c-command into subsequence, instead of precedence. This second option will yield the complement-head-Spec order. Kayne (1994) considers the first possibility to be the right one.

⁴⁸ Ordóñez (1997) points out that Chomsky's (1995) bare phrase structure system does not have these consequences. Chomsky dissociates the notions of maximal/minimal and projected/non

Before turning to the subject of adjunction, the other important dimension in the antisymmetry approach, let us illustrate briefly the consequences of this analysis up to now. According to this view, the different surface order we see between English and Japanese, for instance, is a product of movement. While in English the object remains in complement position, in Japanese it gets displaced to the left and becomes a specifier, as (44a) and (44b) reflect:

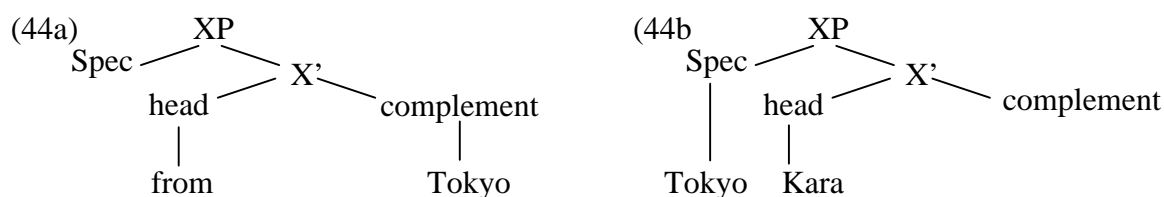

According to this hypothesis, these English and Japanese examples do not merely differ with respect to linear order; they also differ with respect to hierarchical structure. This means that the object in Japanese is not only to the left of the preposition, but it is also more external in hierarchical terms.

A parallel case can be found when analyzing preverbal and postverbal subjects in Spanish. See the examples in (45) and (46):

(45) una canción canta Marta

[a song sing-3rdps Marta]

(46) Marta_i canta una canción *pro*_i

[Marta sing-3rdps a song *pro*]

projected as in Muysken (1982). For Chomsky, an intermediate X' projection is not maximal and not minimal and is, therefore, invisible for the computational system. Thus, X' is not able to c-

The OVS order in (45) is a product of V-movement, while the SVO order in (46) is the result of the adjunction of the subject and the chain relationship that is established between this and the resumptive pronoun in postverbal position (*pro*); that is, a preverbal subject implies adjunction, not subject movement, the (postverbal) subject position being occupied by empty *pro*. Sentences with postverbal and preverbal subjects are, therefore, products of different numerations. In this way, the traditional explanation that accounted for cases such as the ones in (45) in terms of being derived from the basic order in (46) has been totally abandoned.⁴⁹

Thus, one of the outcomes of this hypothesis is that every difference in linear order in the same language or across languages must reflect a difference in hierarchical structure.

1.3.3. Adjunction

As we have seen, the operation *merge* forms an item K from the elements X and Y. In this operation, the nature of the merger is either substitution (*set-merge*) or adjunction (*pair-merge*). Adjunction has an inherent asymmetry: X is adjoined to Y.

Under the antisymmetry approach, multiple adjunction to the same head, or multiple adjunction to the same maximal projection are banned. However, more than one adjunction is still allowed in what is known as successive adjunction where adjunction structures are permitted in the system because the adjoining category excludes the projection to which it is adjoining (the adjoiner). Moreover,

command into its sister specifier. Since Chomsky's system maintains the notion of intermediate projection and separate segments, adjuncts and specifiers are formally distinguished.

⁴⁹ See next chapter for a detailed analysis.

adjunction creates segments which by definition cannot c-command.⁵⁰ The definition of c-command provided by Kayne (1994, 16) is found in (47) and (48):

- (47) X c-commands Y iff:⁵¹ X and Y are categories
 X excludes Y (no segment of X dominates Y)
 every category that dominates X dominates Y

(48a) X c-commands Y

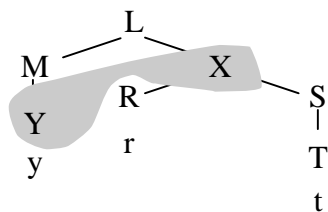

(48b) X does not c-command Y

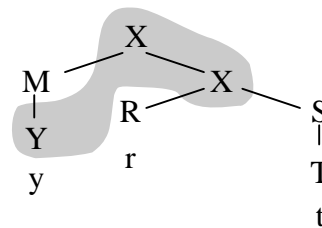

In (48a), X asymmetrically c-commands Y. In (48b), the lower X does not c-command Y since lower X is a segment and not a category.

Thus, we can always create antisymmetry by adjoining to a category, iff this category has not already been adjoined to. One example of this type of adjunction is given in the following tree in (49), where YP is adjoined to ZP:

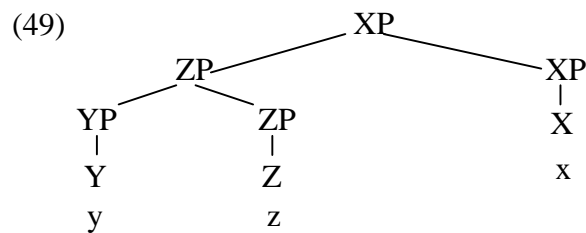

YP asymmetrically c-commands ZP since it excludes it. ZP does not c-command YP because it does not exclude it and the lower segment of ZP does not c-command Y. This is called successive adjunction and is in direct contrast to multiple adjunction.

⁵⁰ See Kayne (1994) for the distinction between segment and category.

The main consequences of this proposal are that a) the borderline between adjunct and specifiers collapses and that both are located to the left of the constituent; and b) multiple specifiers are not allowed, since multiple adjunction is no longer valid. This will have an effect on structures with postverbal subjects and their relationship with objects in Spanish: in VSO order the subject c-commands the object and in VOS order the object c-commands the subject. Therefore, VOS and VSO orders are asymmetrical.⁵²

1.4. Optimality Theory

Optimality theory (OT) is a theory of generative linguistics which started as a theory of phonology (Prince and Smolensky 1993, 1997) but has extended to other areas of language.⁵³ It proposes that UG contains a set of violable constraints which spell out universal properties of language. It also proposes that each language has its own ranking for these constraints. Therefore, differences between constraint rankings result in different patterns and give rise to systematic variation between languages.

1.4.1. Optimality Theory and the Previous Generative Tradition

Being within the generative approach to language, OT, nonetheless, moves away from some of the assumptions in the preceding PP model and in the MP. Archangeli (1997) and Speas (1997) discuss some of these differences and also analyze some of the commonalities between these generative approaches.

⁵¹ Iff stands for “if and only if”.

⁵² See Ordóñez (1997) for an analysis of VOS/VSO orders following the scrambling hypothesis.

⁵³ See Archangeli (1997). For OT in syntax see Pesetsky (1997) and Speas (1997).

There are two main conflicting issues between OT and MP approaches: 1) the way in which they capture the idea of language as the ideal net; and 2) the interrelated notions of markedness and constraints.⁵⁴

1.4.1.1. The Ideal Net: Grammatical *versus* Ungrammatical Sentences

All the possible grammatical sentences in a language constitute the ideal net on which generative linguistics focus. The MP offers a generative mechanism that allows the ungrammatical expressions to escape, permitting only the grammatical ones to be accounted for. On the contrary, OT opts for the ideal separator, that is, a very simple mechanism (GEN, as we will see later on) that allows ungrammatical expressions to be created essentially without restriction, leaving all the work of separating out the ungrammatical ones to filtering devices (EVAL). Both the MP and OT attempt to account for ungrammatical constructions in a given language, but the way in which they deal with this issue is somehow opposite. In the MP, the strategy consists of avoiding the presence of ungrammatical structures; while for OT, it consists of rejecting their possible formation.

1.4.1.2. Markedness and Constraints

The concept of markedness makes reference to the robustness of a given property within a language. In the case of OT, markedness is crucial to the model and it is defined on the basis of two issues: 1) each constraint is a markedness statement; and 2) specific aspects of markedness result from the ranking.

⁵⁴ The notions of markedness and constraints are crucial to OT. Markedness is represented in OT by constraint violation while constraint satisfaction corresponds to unmarked properties. Though we initially present them separately, their interaction will soon be obvious.

When comparing phenomena across languages, the understanding of the variation that does occur also helps to determine these areas where there is no variation. In the MP the more common properties or patterns are thought to be universal. However, due to variation, not all universals are manifested in the same way in all languages. The more robust a universal is in a particular language, the less marked the language is in that respect. A highly marked property is one which has minimal or no claims to universality. Therefore, and viewing this situation from an OT perspective, constraint violations characterize markedness, patterns, variation and also universals. Having this as a starting point, OT redefines the role of constraints and proposes that languages have in common a set of constraints which are violable. Languages vary in the ranking that they impose upon these violable constraints. In this way, the lower the ranking, the more violable the constraint is. So for both the MP and OT, constraints are present in the language, but while in the case of the MP all languages share a core of inviolable principles and differ syntactically as a result of how certain details of each principle are stated (parameters), OT focuses on violable ranked constraints.⁵⁵

One more thing should be said about constraints. As Archangeli (1997) defends, OT goes for the modular nature of language, since it emphasizes a single constraint hierarchy which internally ranks all constraints, whether syntactic, morphological, phonological, phonetic or semantic.⁵⁶ Therefore, this possibility predicts interaction between components and, at the same time, justifies that

⁵⁵ From a minimalist perspective, then, a principle is a statement which expresses a property shared by all languages; principles, therefore, cannot be violated. But as an OT perspective pinpoints, these principles are not absolute either: many principles contain a universal portion and then an open parameter, which may take on different values in different languages, possibly restricted to differences in the strength of grammatical features. (Speas 1997)

⁵⁶ The basic idea of modularity (Fodor 1983) is that the principles responsible for different aspects of an utterance are themselves structured differently. These modules belong to a central system that is more structured than Fodor assumes (Chomsky 1998).

particular syntactic constraints might be violated in order to satisfy a phonetic or morphological constraint or *viceversa*.⁵⁷

Hence, as far as cross linguistic variation is concerned, the differences are clear: under a PP theory, we are dealing with different parameter settings; from a minimalist perspective, the differences are parametrized in terms of different features or in terms of feature strength (strong *versus* weak) and the compliance with economy principles; and OT, in turn, defends the different rankings of violable constraints, depending on the language, leaving aside the concepts of inviolable principles and parameters and viewing feature strength as part of a process of ranking selection.⁵⁸

(50)	<u>Principle</u>	<u>Essence</u>	<u>Hedge</u>
	satisfy	all syntactic features must be satisfied	overtly if they are strong and covertly at LF if they are weak

The interesting connecting point between the MP and OT is the economy condition. In fact, economy principles are the area in which principles are allowed to be violated in the MP. Under a minimalist perspective, economy principles have to apply in all cases and at all points in the derivation. Under an OT view, these strict economy principles can be, and in fact are, violated under certain circumstances (namely, to comply with another principle that is ranked higher and cannot be violated either). For example, in the domain of movement, the fewest possible number of moves is none, so, as Speas (1997) defends, an unhedged

⁵⁷ This vision contrasts sharply with the view of grammar as having a separate and independent syntactic component, phonetic component, etc. Later, we will suggest that this idea can be applied to the case of French subject-verb agreement, with a [+ strong] lexical agreement but a [-strong] phonetic agreement. Pesetsky (1997) proposes an OT analysis of English and French relative clauses in terms of movement and pronunciation.

version of least effort would be violated every time there is movement in the syntax.⁵⁹ Similarly, a strict version of procrastinate is violated whenever there is overt movement; but this violation is acceptable as long as it is necessary in order to avoid violating, following OT terminology, some other UG principle. The way these principles actually work is, therefore, very close to an optimality approach.

1.4.2. Optimality Theory Processes

As for the way OT works, Archangeli (1997) defends that, like any other model of linguistics, OT proposes an input, an output and a relationship between the two. This relationship is mediated by two formal mechanisms, as diagram (V) reflects:

Diagram V

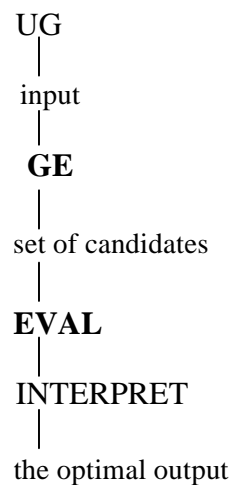

The process diagram (V) reveals is the following. As in previous generative approaches, UG provides a vocabulary for language representation. From this

⁵⁸ Notice that Chomsky's (1998) narrow syntax also involves devices that are imperfections unless shown to be motivated by design specifications.

⁵⁹ A hedge is a clause that extends the principle in order to cover problematic cases which do not obey a simple version of the principle. Thus, hedges take care of cases that would otherwise be violations.

vocabulary, input is composed containing linguistically well-formed objects. The only constraint is, therefore, that the input does not contain non-linguistic objects.

Generator (GEN) is one of the formal mechanisms in this system. It creates linguistic objects and notes their faithfulness relationships to the input under consideration.⁶⁰ The operations it carries out are, *add*, *delete* and *rearrange* among others. It relates input to a set of candidates which is infinite since there are no restrictions.

The other formal mechanism is EVAL (evaluator), which uses the language's constraint hierarchy to select the best candidate(s) for a given input from among the candidates produced by GEN. The constraint hierarchy for a particular language is its own particular ranking of CON (the universal set of constraints). Two ideas have to be stressed at this point: every language has access to exactly the same set of constraints; and any constraint may end up being violated in some language. The potential for being violated is the result of the position of a constraint in a particular language hierarchy rather than a property of the constraint itself.⁶¹

Finally, the optimal output is the one that satisfies these constraints. Since these constraints are ranked, violation of lower ranked constraints is allowed if it is to satisfy ones that are ranked higher.

Speas (1997) provides a series of equivalences between MP and OT processes in the formation of sentences. In both cases we are dealing with

⁶⁰ Faithfulness constraints are a family of constraints whose properties cut across all subdisciplinary domains. They require the output to be identical to the input.

⁶¹ In this sense, as Archangeli (1997) points out, the constraints also provide a measure for markedness: the higher ranked constraints (and so rarely violated) indicate the ways in which language is unmarked; while the lower ranked constraints (and so frequently violated) indicate the ways in which the language is marked.

unordered input.⁶² Also, the OT operation GEN equals those of *merge* and *move* in the MP.

As discussed earlier, language variation is seen in OT as differences in constraint rankings. So that, for example, having two constraints such as A and B, one language may have the hierarchy A >> B, while another language may have the hierarchy B >> A. Specifically, in the case of English and Japanese word-order differences, the OT constraints STAY and SATISFY in (51) are ranked as indicated in (52):⁶³

(51) STAY: do not move

SATISFY: morphosyntactic features must be checked in a specifier position

(52) English: STAY >> SATISFY

Japanese: SATISFY >> STAY

This means that, phrasing it in non-OT terms, in the case of English complements follow their heads since STAY outranks SATISFY, while in Japanese, they precede their heads since the not-movement constraint is ranked lower. In fact, both languages have access to the same set of constraints. It is their particular way of ranking these constraints that will bring about differences between them.

Within OT, the cases of *pro* and expletives are viewed from a slightly different perspective. Since both notions are fundamental to our analysis, we shall briefly reflect the treatment they receive from an OT perspective.

⁶² The input consists of an ordered sequence of words; what is unordered is their grammatical structure (Archangeli 1997)

⁶³ Constraints in OT are indicated in uppercase.

1.4.2.1. *Pro* and Optimality Theory⁶⁴

The analysis of silent NPs (*pro*) in optimality theory stems from a hedge in the principle of Case filter. According to this principle and viewing it from an OT perspective, an NP must have Case unless (and here is the hedge) it is null. Therefore, silent NPs are restricted to caseless positions. The corresponding examples of *pro* we are dealing with are the following in (53) and (54):

- (53) a. **pro* want your history books
b. *pro* quieren tus libros de historia
[*pro*-they want-3rdps your books of history]

- (54) a. my friends want *pro* to travel to Finland
b. mis amigos quieren *pro* viajar a Finlandia
[my friends want-3rdpp travel-infinitive to Finland]

Subject *pro* in finite sentences is not allowed in English (53a) but it is possible in Spanish (53b); while subject *pro* in nonfinite sentences is permitted in both languages (54a and 54b). All occurrences of *pro* as silent NPs contradict the Case filter since they have no Case.

⁶⁴ In PP, it is conventional to represent the null subjects of nonfinite clauses in uppercase (PRO), called big *pro*, such as the one in (i), and other null pronouns in lower case (*pro*), called small *pro* or little *pro*, like in (ii). However, some authors do not treat the two as distinct and use *pro* to refer to both big *pro* and small *pro*. This is the view we will adopt here, though our main concern is subjects in finite clauses:

- (i) I want PRO to go
(ii) *pro* necesitamos un libro sobre biología marina
[*pro*-we need-1stpp a book on marine biology]

Thus, the OT approach, though it maintains the nature of syntactic principles, allows violations to play a central role in the theory. We will first provide all the working terms (terminology) and then apply them to the specific study of subject *pro* (including nonfinite clauses but mainly focusing on finite ones). The reorganization of the analysis is based on two main assumptions:

- 1) constraints are universal and therefore English and Spanish, in the distribution of *pro* in this particular case, will be affected by the CONTROL, the FREE PRONOUN, the MAX(PRO) and the CASE constraint, as we will see; and
- 2) the ranking of these constraints is language-specific, which means that the languages under analysis may and will in fact impose a different ranking, a different hierarchy, for the aforementioned constraints. This ranking will bring about the violation of some of these constraints in order to satisfy a highly-ranked constraint.

Specifically, the different ranking for English and Spanish for the distribution of *pro* is as in (55a) and (55b) respectively:

- (55) a. English: CASE >> CONTROL >> FREE PRONOUN >> MAX(PRO)
b. Spanish: CONTROL >> FREE PRONOUN >> MAX(PRO)

The constraints are defined in the following terms, according to Speas (1997):

- (56) a. CASE: Case-marked NPs must appear in Case positions (e.g. subject position)
b. CONTROL: a null pronoun must be controlled in its control domain⁶⁵

⁶⁵ The relevant term *control* in GB theory makes reference to a relation of referential dependency between an unexpressed subject (the controlled element) and an expressed or unexpressed constituent (the controller), the referential properties of the controlled element being determined by

- c. FREE PRONOUN: a null pronoun must be free in its governing category
- d. MAX(PRO): if *pro* occurs in the input, then its output correspondent is *pro*

As a null pronoun, *pro* is subject to both the CONTROL and the FREE PRONOUN constraint (principle B in the binding theory). Starting from the MAX(PRO) constraint, a faithfulness constraint, its interaction with the CONTROL constraint excludes *pro* from Case marked positions. This accounts for the presence of *pro* in non-finite clauses both in English and in Spanish; moreover, since overt NPs cannot occur in caseless positions (CASE constraint), an overt NP subject in non-finite clauses as in (57) will violate CASE:

- (57) a. *my friends want they to travel to Finland
 b. *mis amigos quieren ellos viajar a Finlandia
 [my friends want-3rdpp they travel-infinitive to Finland]

The interaction between CONTROL and FREE PRONOUN ensures that *pro* is obligatorily controlled when there is a c-commanding antecedent in its control domain. This will be the main difference between English and Spanish, which is reflected in the occurrence of *pro* in finite clauses in Spanish but not in English. In English the CASE constraint outranks all others (including the CONTROL constraint) since in this language *pro* is always restricted to caseless positions. In Spanish, on the contrary, the highest constraint is CONTROL since

those of the controller (Bresnan 1982 and Haegeman 1994). In OT, the CONTROL constraint and the term itself are used somewhat differently, making reference rather to licensing or governing. This is the way we will use the term here.

subject *pro* is allowed when it is controlled (by the subject rich agreement element in V).

In this way, the agreement mechanism can also be viewed from an OT perspective. As Speas (1997) shows, the presence of null subjects in Spanish and its absence in English is defined by the different ranking of constraints that places CONTROL as the highest constraint in Spanish, as opposed to CASE which is the highest constraint in English. As Harbert (1995) shows, Agreement functions as a controller of *pro* in Spanish, since Agreement is [+strong] and *pro* is within the domain of Agreement. Such a relationship is not possible in English since Agreement is [-strong].

The presence of subject *pro* in English (non-finite clauses) and in Spanish (non-finite and finite clauses) is seen in OT terms as a difference between the universal CASE and CONTROL rankings and their relative order in the ranking, which is language-specific.

1.4.2.2. Expletives and Optimality Theory

Expletives are also dealt with within OT.⁶⁶ Again there is a change of perspective and principles (PP and MP) are abandoned in favor of constraints (OT). The two main principles at issue when dealing with expletives are the EPP and the full interpretation principle (FI) (for OT both principles contain a hedge). With regards to the EPP, all clauses must have a subject unless (and here is the hedge) their predicates have no arguments and the language lacks overt expletives (which

⁶⁶ The difference between English overt expletive there in subject position in finite clauses and Spanish null/overt expletive *pro* in subject position in finite clauses is explained in terms of the different ranking for each language, as it was explained in the previous section.

is the case of Spanish expletive *pro*).⁶⁷ The FI principle states that there can be no superfluous symbols in a derivation unless (and here is the hedge) those symbols are expletives. Therefore, both principles may not be obeyed under certain circumstances. Under PP, expletives like there delete right before the point at which they are semantically interpreted, but they survive phonetically. Under this analysis, then, we still have superfluous symbols in a derivation (there and expletive *pro*).

If we take the OT constraints to be SUBJECT (the EPP) and FULL INTERPRETATION, as in (58):

(58) a. SUBJECT: all clauses must have a subject⁶⁸

b. FULL INTERPRETATION: there can be no superfluous symbols in a derivation

and if we accept that both, as universal constraints, are present in English as well as in Spanish, the difference between these languages will be located in the way these constraints are ordered in the ranking; that is, both can be violated to satisfy more highly ranked constraint. The question is which one of them will be ranked higher. The rankings are as in (59):

(59) a. English: SUBJECT >> FULL INTERPRETATION

b. Spanish: FULL INTERPRETATION >> SUBJECT

⁶⁷ As we will see later, the lack of overt expletives in Spanish may also be understood as the lack of *pro* altogether in expletive structures, where 3rd agreement plays the role of the subject (Kato 1999).

⁶⁸ Grimshaw and Samek-Lodovici (1995).

In English SUBJECT outranks FULL INTERPRETATION since the presence of uninterpreted elements such as the expletive there is tolerated in order to fulfil other grammatical principles, to comply with the high constraint. In Spanish, the lack of overt expletive elements (or lack of *pro* in these structures, as Kato 1999 defends) is reflected in the hierarchy in (59) where FULL INTERPRETATION outranks SUBJECT, this last one being somehow violated in order for the derivation to include superfluous symbols and, therefore, violating the highest constraint.

As seen from the previous sections, both antisymmetry and optimality try to account for language variation. The way they approach this is different, though, but it basically contains the same underlining principles. In the case of antisymmetry, language variation is explained in terms of different processes and operations applied to a universal word order. Optimality, in turn, accounts for the same phenomenon in terms of a different ranking hierarchy from the set of universal constraints.

1.5. Other Developments in the Theory

Apart from these two different general approaches to the way sentences generate, a series of more local developments of the theory have contributed to the advancement of the analysis of language, also within the generative tradition. Among them, we will focus specifically on three which will be relevant for our study and which cut across the PP theory and the MP: the split inflection hypothesis, the VP-internal subject hypothesis and the pro-drop parameter (now the null-subject parameter). Some of these proposals have been mentioned in previous sections with reference to the position of the subject in the sentence. Since their

reformulation is fundamental for the analysis in chapters two and three and in order to not lose the thread of the argumentation, we will deal with them now in a more detailed way.

1.5.1. Pollock (1989): The Split Inflection Hypothesis

The theory of PP serves as the basis for Pollock's (1989) comparative analysis between English and French.⁶⁹ From this theory, Pollock (1989) makes use of three constructs which act as the framework for his work when analyzing and articulating his proposal: the empty category principle, theta-theory and c-command. At the same time and in view of these constructs, Pollock (1989) proposes a new parameter of variation, the opaqueness/transparency of agreement phrases. This parameter also distinguishes among languages as any other parameter does (null-subject parameter, word-order parameter, etc.).

One of Pollock's (1989) central contributions is the split inflection hypothesis which constitutes the first step towards the parameter of the opacity/transparency of AgrP and its comparative value. This hypothesis states that the inflection node is made up of two different and independent constituents which he calls tense phrase and agreement phrase (TP and AgrP);⁷⁰ a third was added to these in Pollock (1993), mood phrase.⁷¹ The importance of these three nodes lies in their potential to become barriers to certain types of movements. The following tree diagrams illustrate the organization of nodes previous to Pollock (1989) in (60a)

⁶⁹ Pollock (1989) is basing his analysis on previous work by Emonds (1976, 1978, 1985) who had already observed these differences between English and French.

⁷⁰ Pollock (1989) proposes the split inflection hypothesis in order to justify the need for short verb movement both in English and in French, that is, for a double movement from VP position to IP (from VP to Agr and from Agr to T), since direct movement will result in a violation of the ECP, as he demonstrates.

⁷¹ Pollock (1993) argues that the present and past tense morphology associated with "light" verbs like modals be, have and do are realized as indicative mood markers.

and the incorporation of the split inflection hypothesis in (60b):

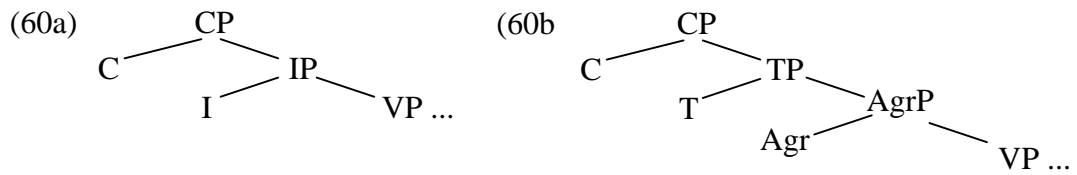

Several linguists (Ouhalla 1990, Chomsky 1991 and Koopman and Sportiche 1985) have modified Pollock's (1989) initial proposal mainly focusing on agreement and the position of the subject, both of which are relevant issues for our analysis.

Ouhalla (1990) states that AgrP should be higher in the tree than Tense, as shown in (61). For this assumption, Ouhalla (1988) draws his conclusions from evidence in languages where Agr and T are morphologically distinct, as in Turkish, for example:

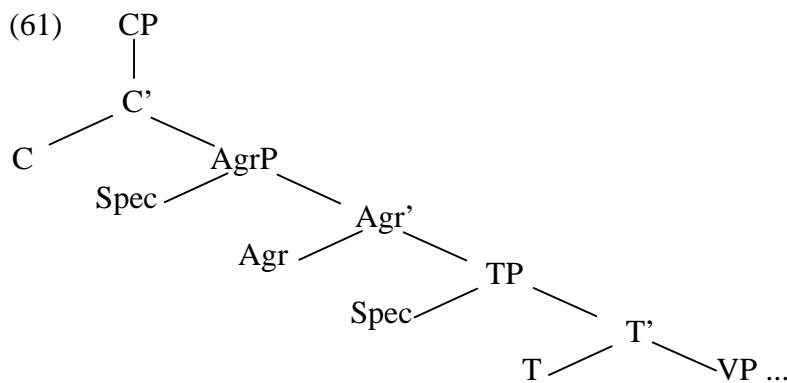

The split of Agr into AgrS and AgrO is proposed by Chomsky (1991). He argues that there are two kinds of verb-NP agreement, one with the subject NP and one with the object NP. Following this assumption and in line with Pollock's (1989) reasoning, two agreement elements appear: subject agreement and object agreement. Regarding the placement of both nodes in the tree diagram, AgrO

should be close to V, while AgrS should be near T.⁷² This is illustrated in (62):

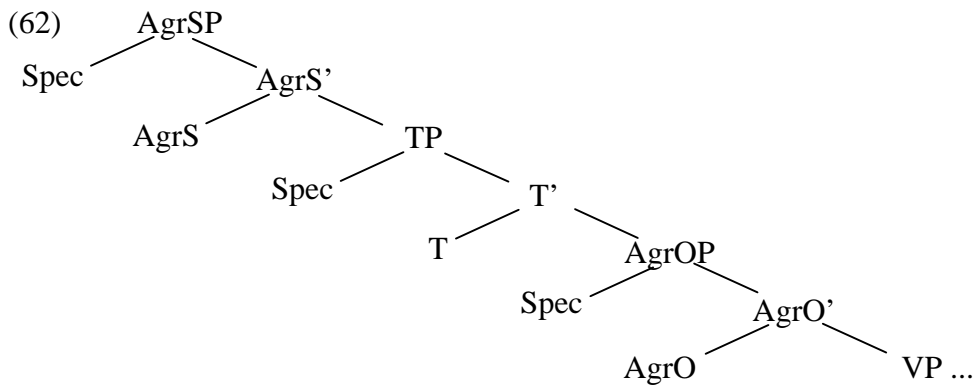

For the placement of the subject in the tree, the VP-internal subject hypothesis proposed by Koopman and Sportiche (1985, 1991) is being followed, as shown in (63):

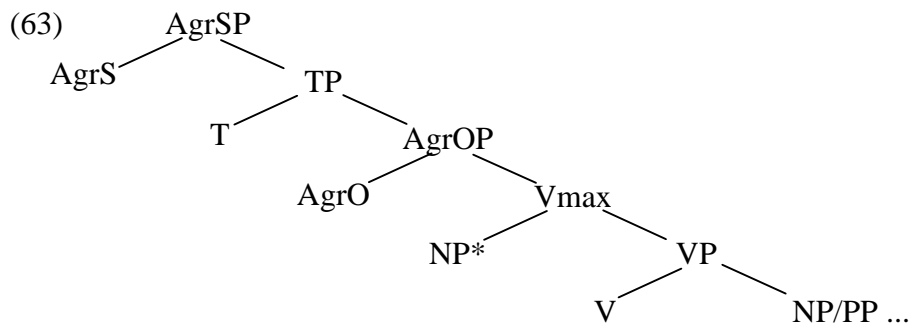

According to these authors, the canonical position of the subject acts as an external argument to the VP. Therefore, NP* is in the subject position of a small clause (Vmax) with the VP predicate; that is, NP* is generated external to VP.⁷³

The entire combined proposal with the new nodes is shown in brackets (64) and the tree diagram (65):

⁷² This split of Agr into two nodes will affect, among others, the analysis of agreement in participle constructions, as defended by Kayne (1989a). See also, in previous sections, the different treatment of Agr nodes in the MP.

(64)

$\left[e \left[\left[\text{MP } M \text{ (Neg P)} \left[\text{AgrSP AgrS} \left[\text{TP } T \left[\text{AgrOP AgrO} \left[\text{VmaxP NP}^* \left[\text{VP (adv) V NP ...} \right] \right] \right] \right] \right] \right] \right]$

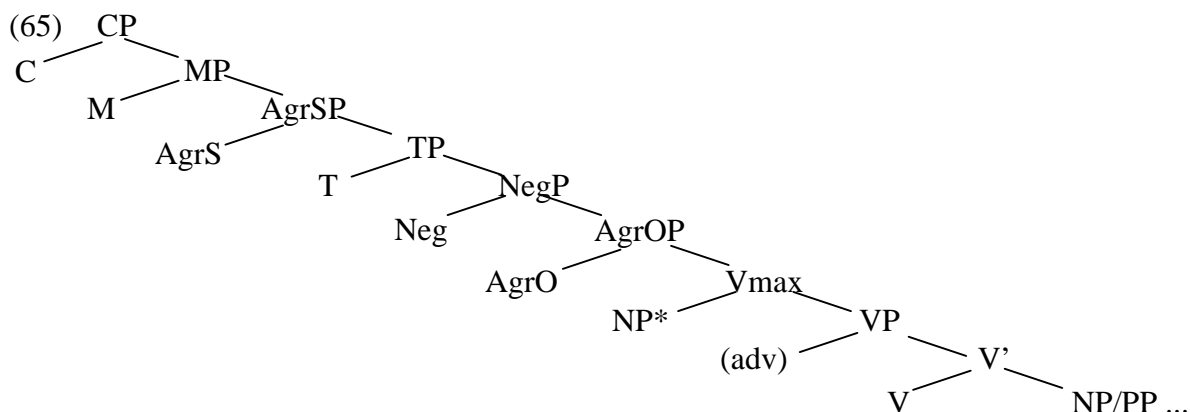

In the elaboration of the brackets in (64) and the tree diagram in (65), which include the three new nodes, a combination of four different proposals is presented. Thus, while it remains faithful to Pollock's (1989) split inflection hypothesis, it also includes Ouhalla's (1990) Agr-T order,⁷⁴ Koopman and Sportiche's (1985) VP-internal subject hypothesis,⁷⁵ and Chomsky's (1991) AgrS-AgrO proposal. We will follow here the arrangement of constituents which is reflected in the tree diagram in (65). Nevertheless, depending on the topic under discussion, and in order to simplify the analysis for the sake of clarity, not all the nodes will be presented in every tree diagram. Those that are not pertinent for the punctual analysis will not be presented.⁷⁶

Since Pollock's (1989) proposal for verb-movement differentiates between

⁷³ Other proposals (Kitagawa 1986, Kuroda 1988, Speas 1986, etc.) differ from Koopman and Sportiche's proposal in that the NP* is generated in the specifier position of the VP headed by the main verb; that is, it is a sister to V'.

⁷⁴ Along with Belletti (1988), who suggests the same conclusion, providing morphological evidence; also Chomsky (1988) and Ouhalla (1988).

⁷⁵ Previously proposed by Zagona (1982) and, for Spanish, by Contreras (1987).

tensed and infinitival clauses, we will deal with them separately. Nevertheless, our focus in this analysis will always be on tensed clauses. As a starting point, we will also extend his analysis to Spanish which is considered a French-type language as opposed to English.⁷⁷

1.5.1.1. Tensed Clauses

Regarding tensed clauses, verb movement is restricted in English to the auxiliary verbs be and have, as shown in (66). For the remainder of lexical verbs, checking theory (Chomsky 1991, Pollock 1993) has to apply.⁷⁸ This lexical restriction is more clearly seen at surface structure when there is an adverb in the sentence as indicated in (66) and previously seen in (12):

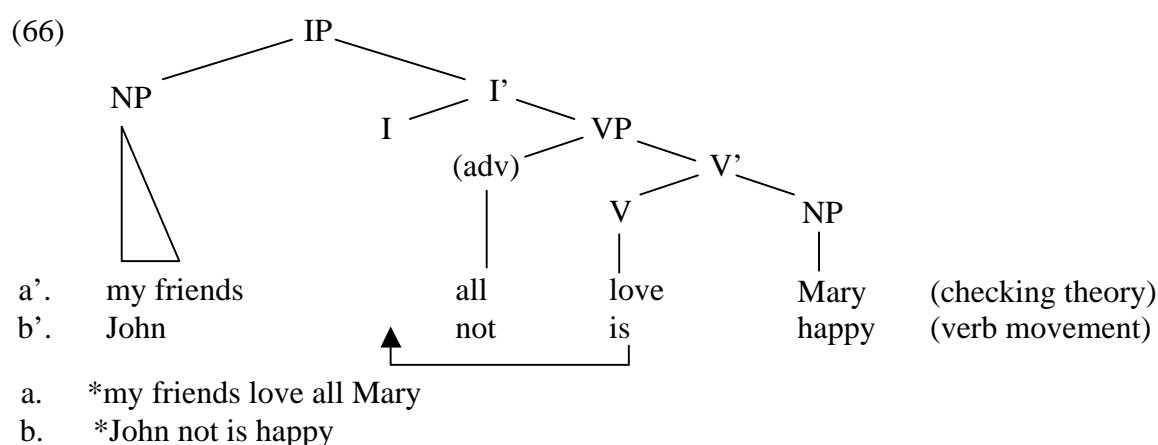

In (66a') above, no verb movement can occur because love is a lexical verb and therefore it appears to the right of the adverb. If movement takes place, the verb appears to the left of the adverb and therefore yields an ungrammatical sentence such as (66a). That is, for lexical verbs in English, only those verbal features that

⁷⁶ See previous section 1.2.2.2. for the minimalist arrangement of constituents that reformulates these proposals and which is the one adopted in chapters two and three.

⁷⁷ See Fernández Fuertes (1996) for an analysis of the consequences of both Pollock's (1989) and the minimalist proposals when applying them systematically to Spanish as a French-type language.

⁷⁸ Even though Pollock (1989) considers lowering rules in these cases, Pollock (1993) later accepts Chomsky's (1991) checking theory and dispenses with lowering movement.

need to be checked rise to IP; the verb itself remains in VP so that no verb movement applies.

Nevertheless, in the case of auxiliary verbs, verb movement takes place and so the verb is found to the left of the negative adverb not in (66b'). This is always the case in French and Spanish, which, unlike English, do not present lexical restrictions as indicated in (67) and previously seen in (13):

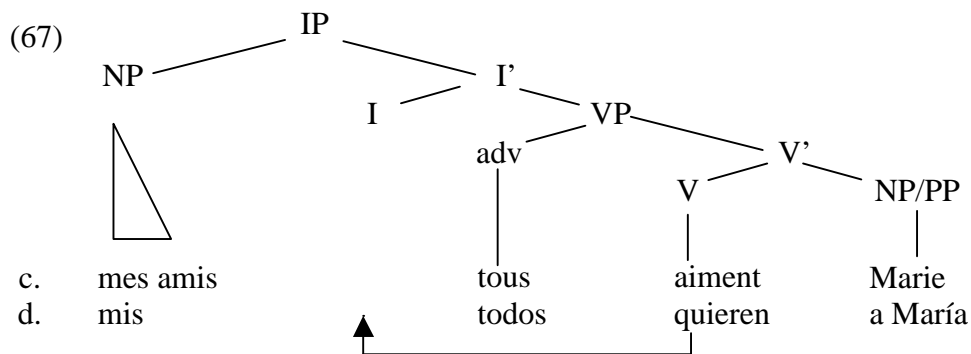

In French and Spanish, both lexical and auxiliary verbs behave like English auxiliary verbs in that they must undergo verb movement.

1.5.1.2. Infinitival Clauses

As far as infinitival clauses are concerned, in this case the same lexical restrictions seem to affect the three languages, so that verb movement affects only auxiliaries. Thus, in the first set of examples (68e,f,g), the verbs speak/parler/hablar appear to the right of the adverb, as in the respective tree diagram in (69):

- (68) e. to hardly speak Italian ... e'. *to speak hardly Italian ...
 f. à peine parler l'italien ... f'. [parler à peine l'italien ...]
 g. apenas hablar italiano ... g'. [hablar apenas italiano ...]

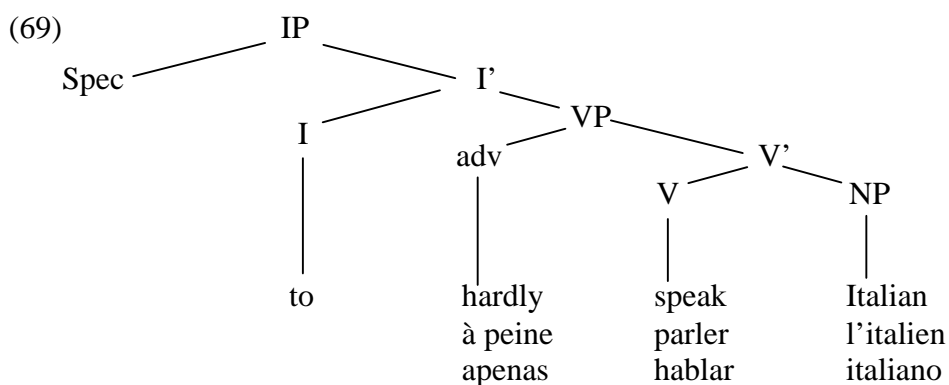

Auxiliaries, on the contrary, can optionally undergo verb movement, hence the double possibilities in this last set of examples with be/être/ser (70h,i,j). The tree diagram which corresponds to these examples is reflected in (71) where the split inflection hypothesis has been included in order to clearly show the double possibility available:

- (70) h. not to be happy ... h'. ?to be not happy ...
 i. ne pas être heureux ... i'. n'être pas heureux ...
 j. no ser feliz ...

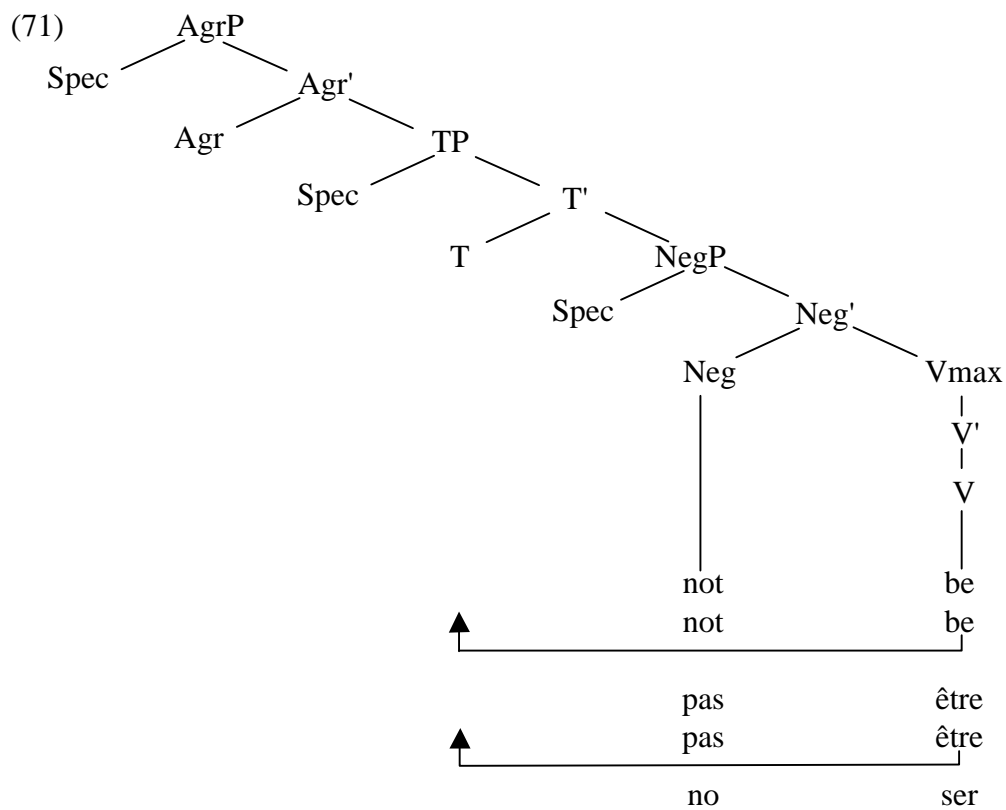

Based on the above, Pollock's (1989) proposal for verb movement could be summed up by using table (II):

Table II: Pollock's (1989) agreement parameter: English, French (... and Spanish)		
verbal typology	WEAK AGREEMENT English	STRONG AGREEMENT ⁷⁹ French and Spanish
tensed clauses (obligatory)	be, have (a) *my friends love all Mary (a') my friends all love Mary (b) *John not is happy (b') John is not happy	all verbs (c) mes amis aiment tous Marie (d) mis amigos quieren todos a M.
infinitival clauses (optional)	be, have (e) to hardly speak Italian ... (e') *to speak hardly Italian ... (h) not to be happy ... (h') ?to be not happy ...	être, avoir/ ser-estar, haber (f) à peine parler l'italien ... (f') [parler à peine l'italien ...] ⁸⁰ (g) apenas hablar italiano ... (g') [hablar apenas italiano ...] (i) ne pas être heureux ... (i') n'être pas heureux ... (j) no ser feliz ...

As we have seen, from the comparison of previous examples of English and French/Spanish, Pollock's (1989) conclusions seem to be accurate in the grouping of both Spanish and French on the one hand and English on the other: in both Spanish and French all verbs in tensed clauses undergo verb movement, and, regarding infinitival clauses, être, avoir/ ser-estar, haber are the only ones which allow such movement. Initially, this analysis seems to work nicely for Spanish, but some problems arise when considering Spanish systematically as a French-style language. Thus, we expect this division to hold up in all cases, but according to examples such as the ones in (72) and (73), the previous assumptions fall short at least partially:

- (72) a. I **have** often **sung** this song (73) a. **she/Mary** has come to the party

⁷⁹ See the next chapter for Contreras' (1991) proposal of the [+/- lexical] dimension of Agr.

- b. j'**ai** souvent **chanté** cette chanson b. **elle/Marie** est venue à la fête
- c. ***he** a menudo **cantado** esta canción c. **pro/María** ha venido a la fiesta

(72) reflects the placement of adverbs in compound verbal constructions. Although one expects the Spanish pattern to mirror the French pattern, no such pairing is achieved. While French and English display similar behavior in that they allow the adverb to be placed between the auxiliary and the verb, such structure is ungrammatical in Spanish. There exist at least two other cases in which Spanish seems to depart from French-type languages. They are both illustrated in (73) and they make reference to the null-subject parameter (only present in Spanish but not in English or in French), as well as to participial agreement (only found in French).⁸¹

A re-definition of Pollock's (1989) proposal is required in order to account for cases such as the ones in (72) and (73). We will try to demonstrate that the presence of other phenomena as well as the new approach provided by the MP as the new development of GB Theory will be required in this attempt to formalize an overall proposal that accounts for the previously mentioned stranded cases.⁸²

1.5.1.3. The Predicate Loc

In spite of all of the aforementioned parametric differences between

⁸⁰ Pollock (1989) explains the constructions in (f') and (g') (Spanish pairing French again) as being derived from a rule that moves the object to the right, adjoining it to VP, so that no verb movement, in fact, takes place: [NP I [[V e adv] NP]].

⁸¹ Unlike the approach adopted here for French, Roberge (1986, 1990) and Authier (1992), among others, consider French a pro-drop language.

⁸² Lasnik (1996) also argues for a re-definition of Pollock's (1989) V-movement analysis to include cases such as the ones in (i)-(iii), where auxiliary raising is accepted in finite clauses, as in (i) but not in the corresponding non-finite ones, imperatives (ii) and infinitivals (iii):

- (i) John is not noisy
(ii) *be not noisy [don't be noisy]

English, Spanish and French, common ground can also be drawn from Pollock's (1989) analysis. Thus, his proposal of Loc (locative) as a predicate assigning theta-role holds up not only for English and French, but also for Spanish, as shown in (74) and (75):

- (74) a. this city has 10 million inhabitants Loc covert Loc
 b. esta ciudad tiene 10 millones de habitantes Loc
 c. cette ville a 10 millions d'habitants Loc
- (75) a. there are 10 million inhabitants in this city overt Loc
 b. hay 10 millones de habitantes en esta ciudad
 c. il y a 10 millions d'habitants dans cette ville

A covert Loc seems to be present in the three languages in the examples in (74), and these are paired with the corresponding examples in (75) where the Loc is overtly expressed. All three languages, English, Spanish and French, seem to follow the same pattern as far as Loc is concerned.⁸³

1.5.1.4. Pollock and the Minimalist Program

Assuming Pollock's (1989) parameter, we have strong and weak inflectional affixes. The [+ finite] choice for I (tensed) is strong and the [- finite] choice (infinitive) is weak. Agr is strong in French (and Spanish) but is weak in English.

(iii) *I believe that to be not a solution

⁸³ This issue will be further developed in chapter three on expletives.

As Chomsky (1995) points out, Pollock's (1989) analysis complies with the "least effort" condition because it crucially relies on the principle that raising is necessary if possible, since shorter derivations are always chosen over longer ones.⁸⁴

Olarrea (1996) also adopts Pollock's (1989) hypothesis. He agrees that the distribution of non-intrinsic categorial features and their strength among functional heads in the lexicon determines the pattern of overt and covert movement for a language. These features are thus the only instance of parametric variation among languages. If the lexicon contains a functional projection (either T or AgrS) with a nominal feature, it will exhibit overt subject movement. When this functional projection has a verbal feature, the language will exhibit overt verb movement. In an attempt to give a minimalist perspective to Pollock's (1989) hypothesis, he explains the classical distinction between verb movement in French and English, i.e., the distinction between V-to-I and I-to-V movement proposed in Emonds (1980) and developed in Pollock (1989), in terms of the different strength of features in Agr, and he also applies minimalist principles of economy. As Pollock (1989) shows, the presence of a [+strong] verbal feature in Agr explains why verbs must raise in French/Spanish. In the case of English, V-related features in Agr are [-strong] therefore, in order to explain why verbs (non-auxiliary verbs) do not raise in English, the economy principle of procrastinate (move as late as possible) is used in the following way. As Pollock (1989) points out, V-to-I movement in English is covert and it is so because it takes place after Spell-Out. The reason for it is to be found, as Olarrea (1996) shows, in the application of economy principles

⁸⁴ Therefore, the least costly derivation is used. Cost is determined by length, but a more subtle implication is that UG principles are less costly than language-specific rules that are contingent upon parameter choices.

that, as we have already mentioned, are at the basis of the minimalist approach. Since we are dealing with [-strong] features in English, these can wait to be checked after Spell-Out, rendering a more economic derivation and thus complying with the minimalist economy principle of procrastinate that ensures that *move* will take place as late as possible. Since these features are [+strong] in French/Spanish, an after-Spell-Out movement will cause the derivation to crash because [+strong] features have to disappear before Spell-Out.⁸⁵

Principles of economy are, therefore, linked to features. Features determine word order and cause movement operations; movement operations must in turn comply with economy principles (also, items move to satisfy their own requirements, the checking of their features, following the principle of greed which takes us back to economy principles). In that sense, the analysis of features is included in the minimalist approach by means of the indirect relationship between features and economy principles. Therefore, Pollock's (1989) hypothesis may also be accounted for in minimalist terms.

1.5.2. The VP-Internal Subject Hypothesis and Parametric Variation

As we have mentioned before in the case of Pollock's (1989) hypothesis, and under the PP framework, the position of subjects has been explained in terms of the VP-internal subject hypothesis (ISH). The ISH claims that subjects are generated in the specifier of the verb phrase ([Spec VP]) as in (76):⁸⁶

⁸⁵ This analysis may also receive an OT treatment in the sense that in Spanish/French violation of procrastinate is permitted in order to comply with a higher principle (overt syntax requirements), while in the case of English, procrastinate is higher in the ranking hierarchy and cannot be violated.

⁸⁶ See Koopman and Sportiche (1991) for an analysis of NP subject generated as sister to VP

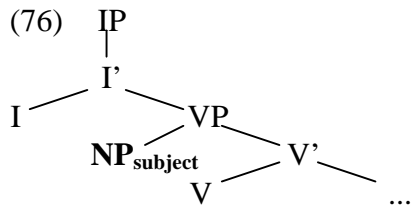

Since V moves to I, either overtly as in Spanish or covertly as in English, preverbal subjects are, therefore, the result of the raising of the subject from its original position within VP to [Spec IP], as (77) reflects:

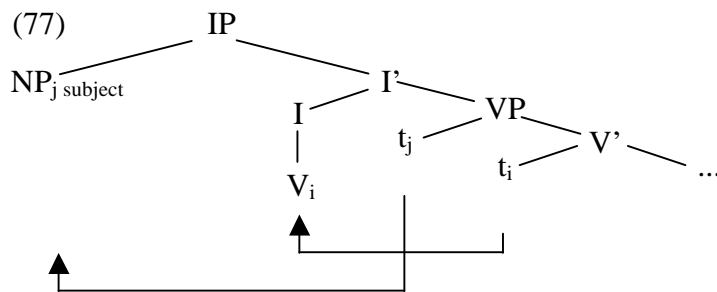

The immediate cause for this hypothesis is Case assignment and in that sense, parametric variation will be explained in terms of the mechanisms of Case assignment. Koopman and Sportiche (1991) propose that nominative Case may be assigned in two different ways: under government or by agreement. First, I assigns Case to an NP that is governed by it, as in (78):

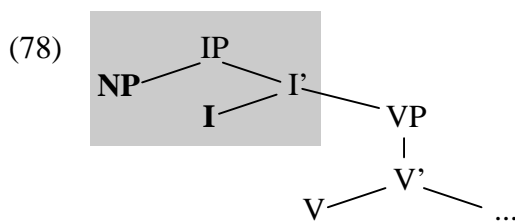

The NP subject in (78) is governed by I under the following definition of government and m-command. A governs B iff: A is a governor; A m-commands B

(that is, iff A does not dominate B and every maximal projection that dominates A also dominates B); and no barrier intervenes between A and B.⁸⁷ Under such a government relationship, I assigns nominative Case to the NP subject located in [Spec IP].⁸⁸

The PP assumption that Case marking requires government is dispensed with in the MP in favor of more local X-bar theoretic relations, now reformulated in terms of *merge*, under the Spec-head agreement approach, as in (79):⁸⁹

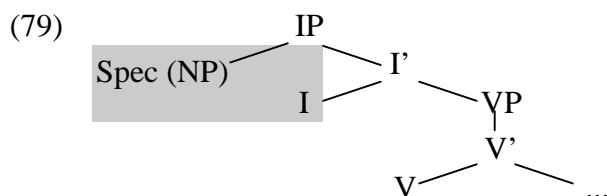

Under a Spec-head agreement relationship, specifier and head share Number, Gender and Person features. The subject NP, then, enters into two kinds of structure relations with a predicate (V): the first is agreement which involves features shared by the NP and the predicate; and the second is Case, manifested in the NP alone. Within IP, where abstract features are located in the structural positions Agr and T, as shown in the tree diagram in (80):

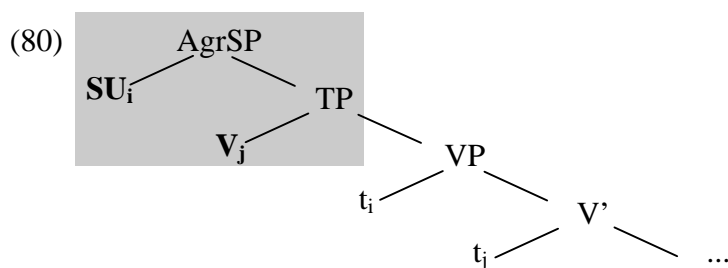

⁸⁷ Maximal projections are barriers to government; governors are heads.

⁸⁸ Notice the contrast in English between subjects of finite clauses which are nominative (he goes to the movies) and those of infinitival clauses which are accusative (they want him to go to the movies). Therefore, in English, nominative Case assignment is associated with finite I.

⁸⁹ Chomsky (1995) and previous work by Koopman (1987) and Kayne (1989b).

Both relations involve Agr in one way or another, either Agr alone, for Agr relations; or the element T or V alone (raising to Agr = IP), for Case relations (Chomsky 1995). Subject-verb agreement is associated with nominative Case and is determined by the relation between subject NP (in [Spec IP]) and I (the head of IP). This relation is uniform at LF but parametrized at Spell-Out before PF; that is, languages vary with respect to the extent to which agreement between specifier and head is morphologically realized. The distinction between the two language-types under analysis is thus reduced to a question of morphology.

In the case of English and Spanish, parametric variation depends on whether or not the internal subject must move to [Spec IP] due to a distinction in the mechanism of structural Case assignment. The different process in languages such as English and Spanish is illustrated in the following examples in (81) and (82):

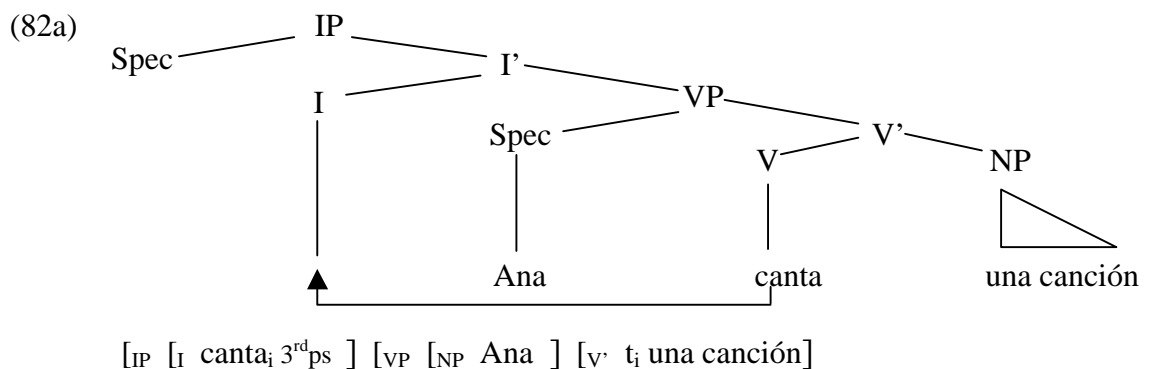
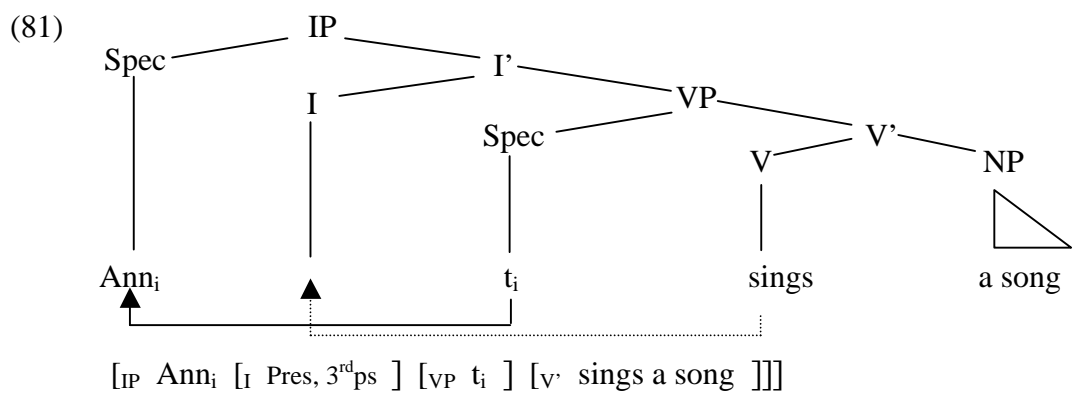

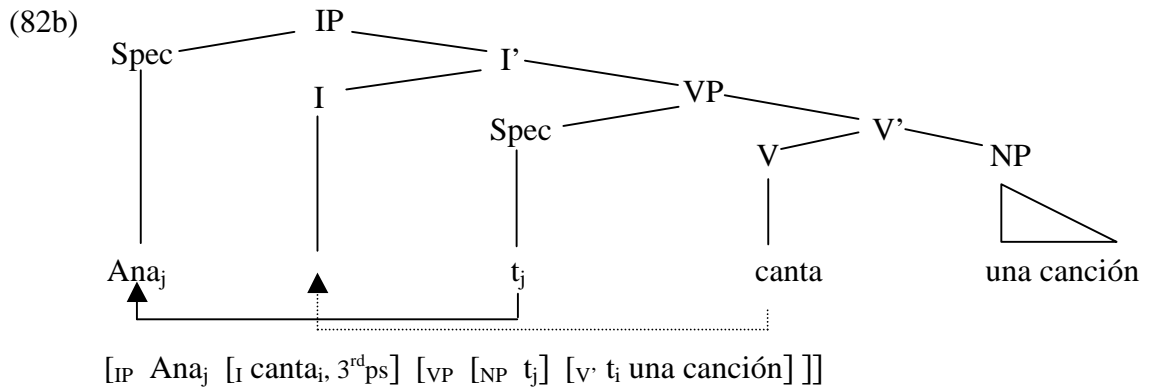

According to the ISH, subjects in any language are generated within [Spec VP]. Also, nominative Case assignment in terms of Spec-head relation between subject NP and I is uniform at LF. The double possibility in Spanish but not in English of preverbal and postverbal subjects leads to a double possibility as well in terms of the subject NP raising from [Spec VP] to [Spec IP] positions. This optional movement for Spanish but obligatory for English will, in turn, affect the mechanism of Case assignment.

The English example in (81) illustrates how NP subjects obligatorily rise to [Spec IP], thereby making all subjects preverbal in English. Under the analysis outlined above, in Spec-head agreement relationships the VP-internal subject raises to [Spec IP] and since it is in a Spec-head relation with I it is assigned nominative Case by I. Recall that verb movement of lexical verbs in English is restricted to feature movement so that I contains features while the lexical verb remains within the VP.

The case of Spanish in the examples in (82) reveals the possibility of preverbal and postverbal subjects in this language, as in (83):

- (83) a. Ana canta [Ana sing-3rdps]
 b. canta Ana [sing-3rdps Ana]

This double possibility reflects that in Spanish, unlike in English, movement of the subject from [Spec VP] to [Spec IP] is optional.⁹⁰ If movement takes place, a preverbal subject appears, as in (83a), whereas, if the subject remains in [Spec VP], the result is a postverbal subject construction, as in (83b). Again, V-movement in Spanish involves the raising of the entire lexical item; hence, in this case, category movement and not feature movement takes place. The different steps are illustrated in the brackets in (84):

- (84) a. [IP [VP [NP Ana] [V' canta]]]
 b. [IP [I canta_i] [VP [NP Ana] [V' t_i]]] verb movement
 c. [IP Ana_j [I canta_i] [VP [NP t_j] [V' t_i]]] subject in [Spec IP]
 └──┬──┘
 Spec-head agreement
 d. [IP [I canta_i] [VP [NP Ana] [V' t_i]]] subject in [Spec VP]

In the case of subject in [Spec VP], subject-verb relation is carried out in terms of Spec-head relation (regarding both agreement and Case). If the subject remains in [Spec VP] then L-marking has to be considered. As opposed to English, I in Spanish is rich enough to be considered lexical;⁹¹ therefore, VP is L-marked, that is, it is transparent to an element contained in it (the subject NP in [Spec VP], and the subject is governed by I.⁹²

⁹⁰ See chapter two for a more detailed analysis of subject positions and movement, where Spanish lacks [Spec IP].

⁹¹ The lexical property of Agr in Spanish will have some bearing in the analysis of weak/strong subject pronouns (including the existence of *pro* and *there*), as we will see in the following chapters.

⁹² Preverbal and postverbal subjects will be dealt with in the next chapter and other proposals will be presented. The optionality of movement in the previous explanation poses problems under a minimalist optic.

1.5.3. The Pro-drop Parameter

One of the most important differences between English and Spanish is captured by means of the so-called pro-drop parameter, Spanish being a pro-drop language and English being non-pro-drop.

The pro-drop parameter is related to Pollock's (1989) parameter of the opacity/transparency of AgrP (IP). This type of relationship is established through the division between languages that have a strong/rich inflection, such as Spanish, and languages that have a weak/poor inflection, such as English.

The analysis of the pro-drop parameter, which was originally perceived in the late 1970's as a constraint that divided languages (especially Romance languages) into two different typological groups, has led to what we could refer to as the new comparative syntax.

The most salient characteristic of pro-drop languages is reflected in what Jaeggli (1981) called the avoid pronoun principle.⁹³ The pro-drop parameter distinguishes between languages that permit null subjects and those that do not. Thus, it groups languages such as English and French, which must have a phonetically realized pronoun, on the one hand, and languages such as Spanish and Italian, which do allow null subjects, on the other. Since it is a weak language as far as inflection is concerned, English does not allow, as a consequence, any licensing of null subjects. Spanish, on the contrary, as a strong inflection language, is a null-subject language which licenses the empty category *pro* in subject position: its recoverability is guaranteed by the rich verbal inflection.⁹⁴

⁹³ For further analysis on the avoid pronoun principle in Spanish see Fernández Soriano (1989).

⁹⁴ Nevertheless, some languages such as Irish, Chinese and Japanese, despite the fact that they do not have rich inflection, allow the presence of null arguments (Jaeggli and Safir 1989). The opposite situation is also found in French, for instance, which, being a [+ strong] language, does not allow null subjects, as will be shown later.

This dichotomy does not however fully explain the case of French and other languages such as German and certain Arab dialects. Even though these are strong inflection languages, they do not have null subjects. It seems clear that morphological richness *per se* is not, at least on its own, a term refined enough to account for the differences among languages. When focusing on French, we are confronted with a peculiar situation where roots are found in the phonetic component: French, having strong inflection, does license null subjects. Nevertheless, when checking theory applies, it cannot check them due to the phonetic convergence of French inflections. This loss of phonetic differentiation or, as one may call it, this loss of inflection in the phonetic form, is what prevents French from having null surface subjects.

Regarding the literature, Perlmutter (1971) was the first to differentiate between two types of languages on the basis of the obligatory presence of the subject in surface structure. Under Perlmutter's analysis, English and French were grouped together.

Rizzi (1986) proposes that for a language to have null subjects, it has to both license them and, at the same time, identify them: recoverability requires identification. Therefore, Spanish has null subjects, since it both licenses (because of its strong Agr) and identifies its subjects (because of its rich morphology), whereas French does not because, even though it licenses them, it cannot identify them.

Jaeggli and Safir's (1989) proposal contends that only languages with homogeneous paradigms allow null subjects: either fully inflected languages, such as Spanish and Italian, or those with no inflection at all, such as Chinese. On the contrary, those languages with a heterogeneous paradigm, with a mixture of pure roots and inflected forms, such as English and French, are not allowed to have null subjects. This principle is referred to in acquisition studies as the principle of morphological uniformity. Thus, as Liceras (1997) states, children would set the null-subject parameter as [+/- null subject] depending on whether they are confronted with verbs with a [+uniform] or a [-uniform] morphological paradigm.

Consequently, the link that could be established between Rizzi's (1986) proposal and Pollock's (1989) [weak/strong] Agr parameter has to be adjusted: weak agreement languages, such as English, can neither license nor identify their subjects and therefore no null subject is accepted. Strong agreement languages, such as French and Spanish, should license and identify their subjects, thus allowing null subjects. Nevertheless, at this point the [+/- phonetic] dimension has to be included and combined with the two previous dimensions, such that only in the case of strong agreement [+phonetic] languages, will null subjects be allowed, as shown in (85):⁹⁵

(85) a. they play the piano

I play the piano

you play the piano

b. (ellos) *pro* **tocan** el piano

(yo) *pro* **toco** el piano

(tú) *pro* **tocas** el piano

c. (ils,) ils **jouent** du piano

(moi,) je **joue** du piano

(toi,) tu **joues** du piano

This analysis of French is based on Authier's (1992) and Roberge's (1986, 1990) proposals concerning present-day French. Roberts (1993) argues in his diachronic analysis of French that Old French allowed null subjects. These null subjects were subject to more restricted conditions than their Modern Italian and

⁹⁵ As previously mentioned, languages such as Chinese or Japanese cannot be analyzed in exactly the same ways in terms of licensing and identification (Huang 1984, Jaeggli and Safir 1989). Regarding the case of subjects in these languages, a different proposal considers them not as empty or null subjects but rather as empty operators whose content could be recovered from the context. Thus, Chinese *pro*, for instance, is licensed by a discourse-bound operator in the specifier of CP and identified by null topics (Liceras and Díaz 1995, 1999).

Spanish counterparts. For instance, null subjects in Old French were more widely attested in root clauses than in embedded clauses. At the beginning of the Old French period, the verbal paradigm had six distinct Person inflections like Spanish, as shown in (86):

- (86) chant chantons
 chantes chantez
 chante (t) chantent

Nevertheless, this paradigm was already reduced to three in spoken Old French. According to Roberts (1993), this phenomenon is the result of two processes: (1) phonetic erosion of final consonants and (2) an operation of analogy which added -e in the first Person singular. Even though he specifically denies suggesting that there is a direct relationship between the identification of *pro* and morphophonemics, we think that phonology may not be totally excluded.

At this point, Roberge's (1986, 1990) and Liceras and Díaz's (1999) proposals can be included, as shown in table (III):⁹⁶

Table III: null-subject parameter: Rizzi (1986), Roberge (1986, 1990), Liceras and Díaz (1995, 1999)			
	ENGLISH	FRENCH	SPANISH
licensing	NO [-strong]	YES in [Spec IP] [+strong]	YES in [Spec IP] [+strong]
identification	NO	YES via subject clitic pronouns	YES via phi-features in Agr
category	overt pronoun	overt pronoun	<i>pro</i>

⁹⁶ Authier (1992) argues as well that French is a pro-drop language on the basis of D.

According to these authors, English (due to its [- strong] feature) does not license nor identify null subjects, while both French and Spanish do. The licensing in both Spanish and French occurs at the level of [Spec IP], as in (87). The difference between French and Spanish lies in the fact that in Spanish identification takes place through the phi-features in Agr, while in French it does so via the subject clitic pronouns.

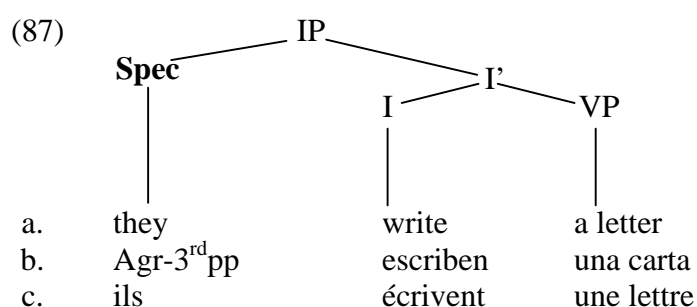

The English examples in (85a) and (87) reveal a weak agreement language both lexically and phonetically: the information provided by the verb fails to discriminate amongst the three sentences so that the subject can only be identified via lexical realization. Notice that the very same verbal form corresponds to three different pronominal subjects: 3rd pp, 1st ps and 2nd ps.⁹⁷ Both French and Spanish, on the contrary, present a lexical variety of endings for each Person. In the case of Spanish, this lexical variety is paired with a phonetic variety. This is what allows for null subjects in Spanish sentences since the Person/Number information can be traced in the verbal endings at both lexical and phonetic levels. The pronouns in parenthesis could be used for emphatic or contrastive purposes, in this way pairing

⁹⁷ The only residual case of verbal endings left in the English paradigm is found in the simple present 3rd ps s, as in (i):
 (i) he/she plays the piano.

the French tonic pronouns (moi, toi ...).⁹⁸

The importance of morphology and specifically the degree of contrastive value, which gives saliency to the various functional categories, has been formalized in Johnson (1990). He proposes a hierarchical arrangement of functional categories, as shown in (88), where Number and Person have their own projections:

(88) PerP NumP TnsP VP

Assuming Johnson's (1990) hierarchy, Hoekstra, Hyams and Becker (1996) propose three language-types according to a variation in the degree of morphosyntactic specification, as indicated in (89):

(89)	language type	Pers	Num	Tense	
	a-type	m	0	Ø	(Spanish, Italian)
	b-type	Ø	m	0	(English, Dutch)
	c-type	Ø	Ø	m	(Japanese)

[m = marked in the morphosyntax; 0 = not marked; Ø = N/A]

In this proposal, the English third Person \bar{s} is a specification of the functional head Number, so that, like Dutch, English is a b-type language.⁹⁹ As these authors maintain, Spanish is an a-type language since it displays Person distinctions as previously shown in (85). Within this analysis, as we have already mentioned, the case of French presents a somewhat different behavior, as reflected in (90):

(90)	parler	
	[je parl]	[nu parlõ]
	[tu parl]	[vu parle]
	[il parl]	[il parl]

⁹⁸ As we will see in the next chapter, all languages have a paradigm of strong pronouns (used for emphatic or contrastive purposes) as well as a paradigm of weak pronouns.

⁹⁹ This idea was first suggested by Kayne (1989b).

As follows from the previous discussion, Spanish emerges as a strongly inflected language with a greater degree of lexical visibility than French, since a different and separate phonetic realization corresponds to each lexical form (verbal inflection in Spanish consists of the combination of three Persons and two Numbers). Thus, as shown in table (V), progressive gradation among the three languages could be established instead of a clear-cut division between English-type *versus* French-type languages, which then complements the distinction proposed by Roberge (1986, 1990) and Liceras and Díaz (1995, 1999):

Table V: comparative agreement features		
English	French	Spanish
WEAK	STRONG	STRONG
[- lexical]	[+ lexical]	[+ lexical]
[- phonetic]	[- phonetic]	[+ phonetic]

Contreras (1991) adds to Pollock's [+/- strong] Agr the [+/- lexical] Agr, Spanish Agr being [+lexical] and English and French being [-lexical]. Nevertheless, at least in the cases under analysis, the [+/- lexical] dimension is not enough and not even completely true as far as the [- lexical] feature attributed to French: French does have lexically distinctive features even though they are not phonetically realized. That is why the [+/- phonetic] feature is included. Thus, although it has to be formalized further, this set of features accurately captures the differences.

Hence, neither the weak/strong dimension nor the [+/- lexical] dimension are enough to capture the important differences between the two [+ strong] Agr languages, Spanish and French. Thus, an explanation will require the interaction of

other processes in order to account for the fact that Spanish is a pro-drop language and French is not.

1.5.4. Recent Accounts of the Pro-drop Parameter (Null-subject Parameter)

Within the MP (Chomsky 1993, 1995), the role played by pronouns and the category *pro* in [+/-null subject] languages is re-analyzed. Under minimalist assumptions, analyses like those of Alexiadou and Anagnostopoulou (1996) and Kato (1999) and Ordóñez and Treviño (1999) consider pronominal agreement as an independent morpheme; that is, verbal endings are considered to be weak pronouns in the same way as unstressed pronouns.¹⁰²

The previous analysis of the null-subject parameter has been treated by different authors. In the case of Alexiadou and Anagnostopoulou (1996), they have tried to accommodate it to the minimalist approach to language.¹⁰³ They propose that agreement morphology in null-subject languages includes a nominal element, following classical tradition in the PP literature. They offer a minimalist account of the properties of null-subject languages in terms of the pronominal properties of I.

In these languages, V-to-AgrS raising is forced by the presence of a [+strong] nominal feature in this inflectional head that forces overt raising of a syntactic element with a nominal feature for the derivation to converge. Since V presents this feature, head movement rather than phrasal movement can satisfy the EPP, i.e. can check the [+strong] nominal feature of the highest inflectional head. Obligatory V-to-I raising in null-subject languages is, therefore, explained and the pronominal properties of inflection in these languages are accounted for. Moreover,

¹⁰² Also Ordóñez (1997).

it is argued that head movement, as in (91), should be considered less costly for the computational system since it does not extend the phrase marker, and is, in this sense, similar to covert movement:

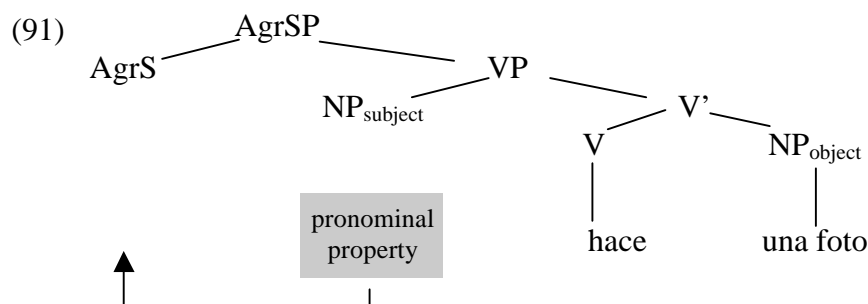

Alexiadou and Anagnostopoulou (1996) claim that the EPP is universally strong since it is a property of sentences (they follow Marantz 1991). On the contrary, Olarrea (1996, 131) states that the EPP, i.e. the nominal feature of AgrS that forces subject raising and with it the checking of its phi-features, is specified as [-strong] in Spanish: V raising is forced by the presence of a categorial verbal feature in AgrS, and this is the strong feature that forces V-to-I movement in null-subject languages.¹⁰⁴

Kato (1999) argues that the distinction between a [+/- null subject] language is located in the distribution of weak pronouns and strong pronouns, as the trees in (92a) and (92b) show respectively:

¹⁰³ As we will see in the following chapter, these authors show that there is empirical evidence to support an analysis of preverbal subjects in null subject languages as clitic-left-dislocated constructions (CLLD).

¹⁰⁴ This difference will have implications on the analysis of SV/VS orders as being the result of the same numeration (as argued by Alexiadou and Anagnostopoulou 1996) or, rather, the product of different numerations (as defended by Olarrea 1996). An analysis of Greek, in the first case, and Arabic, in the second, is provided.

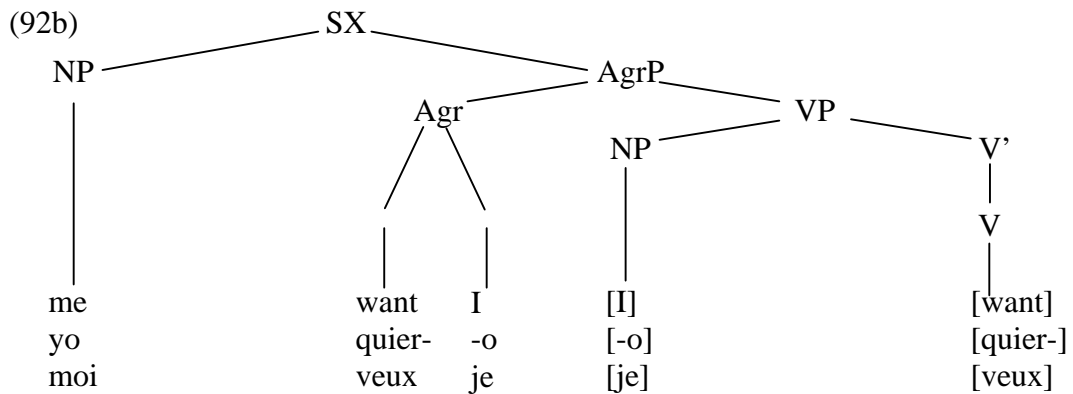
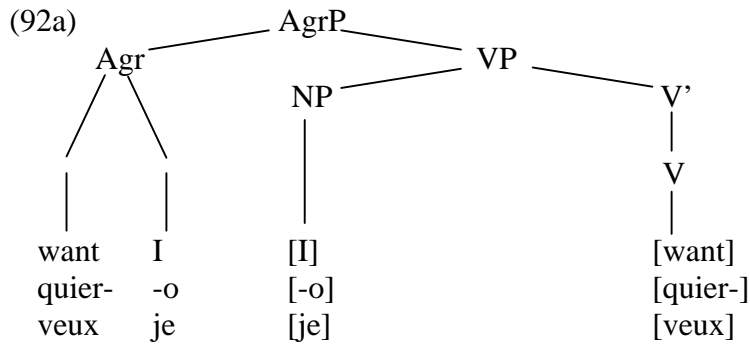

Within the group of weak pronouns, we include nominative Case pronouns in English and French (I, you, he ...; je, tu, il ...) and the null element *pro* in Spanish (that for Kato 1999 and Ordóñez and Treviño 1999 will be pronominal Agr, as we will see). The group of strong pronouns includes the dative/accusative emphatic pronouns in English and French (me, you, him ...; moi, toi, lui ...) and the nominative pronouns in Spanish (yo, tú, él ...), as well as the oblique ones (con él, por ti ...).¹⁰⁵

As in the trees in (92a) and (92b), and for [-null subject] languages or [-pronominal] Agr languages (following Kato's 1999 terminology), weak pronouns merge with a fully inflected verb and may also be doubled by strong pronouns (me, I want ...; moi, je veux ...). This type of duplication is not seen in surface structure

for [+pronominal] Agr languages, since the subject weak pronoun is Agr itself (yo Agr quier-o).

As we have seen in Pollock's (1989) [weak/strong] Agr parameter, the difference in the richness of inflection among the languages under analysis is what is responsible for an implicit Agr in Spanish and French and an explicit Agr in English. As Rizzi (1986) defends, the recuperability of null subjects requires that the subjects be identified, something that is only possible in [strong] Agr languages. That is, the identification of *pro* is possible thanks to a rich inflection. Ordóñez and Treviño (1999) maintain this relationship between inflection and null subjects, but they eliminate Agr as a functional projection. On the contrary, they consider Agr as an argument of the verb, as a clitic that absorbs thematic role and Case (Jelinek 1984 and Taraldsen 1992a, 1992b). In other words, the true argument of the verb is not *pro* but Person Agr.

Kato's (1999) analysis also considers that Agr is not a functional projection. Following Speas (1994), Kato defends that Agr morphemes in null-subject languages have content. Nevertheless, and differing from previous proposals, Kato (1999) proposes the elimination of the empty category *pro* as a D category in favor of a [+pronominal] Agr with the same status as weak pronouns, and, therefore, functioning as the subject in languages such as Spanish. In a verb like the Spanish hablar [to speak] in (93), -o, -s, Ø, -mos, -is, -n will be pronominal Agr, the paradigm of weak pronouns in Spanish:¹⁰⁶

¹⁰⁵ See also Fernández Soriano (1989) and Cardinaletti and Starke (1994).

¹⁰⁶ In the examples in (93), -a- is a thematic vowel, an element of Spanish verbs that is neither part of the root nor of the morphemes.

(93)

habl	-o	I	speak
habl-a	-s	you	speak
habl-a	∅	he/she	speaks
habl-a	-mos	we	speak
habl-á	-is	you	speak
habl-a	-n	they	speak

Kato (1999) terms [+pronominal] Agr the type of agreement that exists in null-subject languages where Agr appears as an independent morpheme in the derivation, with information on Person and Number, in the same way as an NP.

Therefore, Agr does not come as affixed to Verb/Tense; rather, in [+pronominal] Agr languages, that is, in null-subject languages, these independent morphemes combine with verbs as external arguments of V. In this way, Agr morphemes come from the lexicon as items independent from verbs. Verbs in null-subject languages, in their turn, come inflected only for tense.

1.6. The Theory of Word Order in the Literature

Analyses previous to generative grammar approach the relative position of elements in the sentence as part of stylistic and pragmatic processes rather than as a syntactic phenomenon (Contreras 1976, among others). Within the generative framework, word order acquires a different dimension and the focus now is on determining the type of relationship between surface word order and the arrangement of the positions where items are actually generated (previous deep structure). In fact, Kayne (1994) and Chomsky (1995) defend that the basic universal word order is SVO. In most of the cases, generative linguists defend the

idea of a linear order in the arrangement of these positions; the differences between these and surface word order is the result of different transformations and also of the application of certain stylistic rules. While various works deal with such transformations and syntactic processes, the truth is that attempts to conjugate those with more pragmatic, intonational, and stylistic notions have been scarce, at least until very recently.

In considering the relative position of the verb with respect to the subject and the object, the different labels SVO/VSO/SOV proposed by Greenberg (1963) are still used. In Greenberg's (1963) universals of word order, the position of the verb is regarded as an indicator of language type and subjects as operators on verbs. Taking Greenberg (1963) as a starting point and in an attempt to understand relative order as one of the central relations in syntax, Hawkins (1983) offers a typology of a variety of languages. He provides the following information for the languages under analysis here:

- (94) English: (Indo-European: Germanic: West) SVO/v-1;
Pr; NumN, DN, PossN, AN, GN/NG, NRel.
- Spanish: (Indo-European: Romance: West) SVO;
Pr; **NumN/NNum**, DN, **PossN/NPoss**, **an/NA**, NG, NRel;
ES type 9.
- French: (Indo-European: Romance: West) SVO;
Pr; NumN, DN, PossN, an/NA, NG, NRel. ES type 9.

Leaving aside the syntax/pragmatics dichotomy, word-order phenomena have been usually reflected in terms of these six different combinations: SOV,

SVO, VSO, VOS, OVS, and OSV.¹⁰⁷ As in Hawkins' (1983) language index, languages are classified following this typology, the three languages we are dealing with falling into the same pattern, SVO. As shown in (94), the three languages also share other characteristics in terms of the order of demonstrative and noun (DN in 94), and noun plus relative clause (NRel). Though information is mainly focused on items other than the subject, differences appear among the three languages, for example in terms of the numeral-noun order (NumN), the possessive-noun order (PossN) and the adjective-noun order (AN), where Spanish emerges as the most flexible language since it allows two possible orders in each case.

Nevertheless, this typology encounters several problems. The main one is that it is too general and basic, as well as descriptive rather than explanatory in nature. Even if we consider both English, Spanish and French as SVO languages, it is clear that important differences exist among them as far as word order between subject and verb is concerned.¹⁰⁸ Moreover, if instead of comparing different languages, we take only Spanish, we realize that different word-order possibilities are present as well. Thus, both across languages and within the same language, we will find that a more refined treatment of word order is needed. The more than thirty years of research have brought about new ways of dealing with syntax which will affect the treatment of word order and also the certainty that factors other than syntactic ones must be brought into the discussion.

In the case of Spanish, Fernández Ramírez (1951) already pointed out that Spanish has a tendency to postpone the subject and have SV inversion. He distinguishes between two types of inversion: absolute inversion which is not the

¹⁰⁷ In favor of an alternative typology based on two binary parameters OV *versus* VO and SV *versus* VS, see Dryer (1997).

result of the anteposition of other elements; and inversion that is indeed caused by the anteposition of other elements.¹⁰⁹

Contreras (1976) was one of the first to present a generative approach to word order in Spanish. Contreras (1991) defends that subject ordering with respect to VP is free.

Together with these and other related proposals that account for word-order phenomena in terms of different syntactic processes (movement operations in SV/VS occurrences), we will also make reference in our analysis to stylistic processes.

When dealing with word-order phenomena, there are certain factors regarding emphasis and focus that should be taken into consideration as well. In different ways, Hernanz and Brucart (1987) and Zubizarreta (1998) will account for such factors.

Taking as a starting point the functional dichotomy proposed by the School of Prague that divides the sentence into theme (old information) and rheme (new information), Hernanz and Brucart (1987) define two different processes that operate altering the configuration of sentences: thematization and rhematization.¹¹⁰

The relationship between prosody and syntax is the main focus of Zubizarreta's work. Zubizarreta (1998) relies on concepts such as prosodically-motivated movement (p-movement) and nuclear stress rule in order to explain such relationship; moreover, parametric variation will be accounted for by means of the nuclear stress rule.

¹⁰⁸ For some authors (Kayne 1994 and Chomsky 1995, among others) SVO is the basic universal order.

¹⁰⁹ It may be worth pointing out that Fernández Ramírez' (1951) corpus of examples is collected from literary texts.

We will leave this for further sections when dealing with subjects and their different positions in the sentence, involving both syntactic and pragmatic issues.¹¹¹

¹¹⁰ The corresponding terminology in Spanish is *tematización* and *rematización* (Hernanz and Brucart 1987).

¹¹¹ There are many references in the literature for word-order phenomena and informative functions such as theme and rheme, starting with Halliday (1967) and the School of Prague (Beneš 1968, Firbas 1966, Daneš 1974, Shall 1984, Shall et al. 1986). Other works on this topic include, among many others, Hatter (1956), Contreras (1983), Ant (1984), Fernández Soriano (1993), Licerias et al. (1992), Licerias (1994), Ocampo (1989, 1990, 1991), Silva-Corvalán (1984), Bentivoglio (1983) and Delbecque's (1987) statistical analysis.

2. SUBJECTS

Traditionally, both Latin functional grammar and relational grammar have differentiated the notion of logical subject from the notion of grammatical subject. Fernández Soriano and Táboas Baylín (1999) make use of this difference and define these concepts in the following way. Logical subject is associated with a particular semantic value, and, being related to a predicate, it is usually the agent/instigator of the action/event expressed by this predicate. Grammatical subject is associated with a grammatical function and is formally expressed by means of verbal agreement. There is, however, no one to one correspondence between the argument about which something is predicated and the argument that determines the agreement relations.

In this chapter, we will concentrate on overt subjects (preverbal and postverbal) where this correspondence generally holds. However, we will leave existential constructions with impersonal hay and \emptyset subject (either *pro* or default agreement) in Spanish as well as be and overt expletive subject there in English for chapter three. These are a specific type of structures in which the aforementioned correspondence may not be very clear, thus the special nature of their subject

arguments. In both cases, agreement proves to be a crucial factor. As Martínez (1999) defines it, agreement is the relationship between at least two items that is established by means of the repetition, in each of the items, of one of the Gender, Number or Person morphemes.¹¹² The main goal of agreement is to relate and to lexically and syntactically identify the agreeing items.

Before dealing with word order, certain particular issues have to be addressed: the change of perspective regarding subjects from the principles and parameters theory (PP) to the minimalist program (MP); the nature of agreement features; the nature of subjects as either adjuncts or arguments; and the terminological problem regarding the operations included under the general label of subject-verb word order. All these topics relate to the controversial points behind the analysis of subjects and their syntactic behavior.

2.1. Preliminaries

2.1.1. The Principles and Parameters Model, the Minimalist Program and Subjects

Within the core functional categories, Chomsky (1998) distinguishes C (expressing force/mood), T (the tense/event structure) and ν (the light verb head of transitive constructions). The category ν is the one that selects an NP/DP as its external argument (the subject);¹¹³ this argument, as we saw in chapter one, is located in [Spec ν]. Predicates and their arguments are within VP. Arguments overtly raise out of VP into the IP layer for reasons related to checking of Case and

¹¹² Regardless of whether this repetition involves the repetition of the exact phonetic form. For some authors, as we will see, subject function may consist of Person and Number agreement itself.

¹¹³ See Abney (1987) for the DP hypothesis, according to which there are arguments for proposing that those constituents which are standardly referred to as noun phrases are in fact projections of a

phi-features. They will only continue up to the CP layer if they have the appropriate type of interpretation as a topic, focused element, etc. Otherwise, if the argument does not have such an interpretation, it must remain within the IP. We will consider both unmarked subjects (those contained within the IP layer) and also marked subjects (those located in a projection above IP).

As presented in the previous chapter, the VP-internal subject hypothesis (Koopman and Sportiche 1985) resumes parametric variation among languages in terms of the obligatoriness *versus* the optionality of the movement of the internal subject to [Spec IP]. In this sense, and under the PP framework, when comparing languages such as English and Spanish, we are confronted with the following different analyses, as reflected in the examples in (1) and (2) respectively:

- | | | |
|------|--|-----|
| (1) | [_{IP} Martha _i [_I Pres, 3 rd ps] [_{VP} [_{NP} t _i] [_{VP} sings a song]]] | SVO |
| (2a) | [_{IP} [_I Pres, 3 rd ps] [_{VP} canta una canción] [_{NP} Marta]]] | VS |
| (2b) | [_{IP} Marta _i [_I Pres, 3 rd ps] [_{VP} canta una canción] [_{NP} t _i]]] | SVO |

As the examples reflect, in English the only possible order is SVO, that is, only preverbal subjects are allowed; while in Spanish, a double possibility is offered regarding the relative position of the subject with respect to the verb, SV or VS.¹¹⁴

head determiner constituent (determiner phrase). Further refinements of Abney's analysis have been proposed. See Longobardi (1994), among others.

¹¹⁴ We are going to concentrate on subject-verb order, but it is necessary to point out here that in Spanish, when the subject is placed after the verb and an object is present, there are two possible orders. The subject may either precede or follow the object, thus giving way to VSO and VOS orders respectively:

- | | | |
|------|-------------------------|--|
| (i) | canta Marta una canción | [sing-3 rd ps Marta a song] |
| (ii) | canta una canción Marta | [sing-3 rd ps a song Marta] |

See the next section on VOS order *versus* VSO order; also Ordóñez (1997).

The key point that differentiates the examples in (1) and (2) is the mechanism of structural Case assignment.¹¹⁵ Thus, in the English example in (1), inflection (I) assigns Case through agreement and the VP-internal subject must raise to [Spec IP] to satisfy the Case filter, as in (3):¹¹⁶

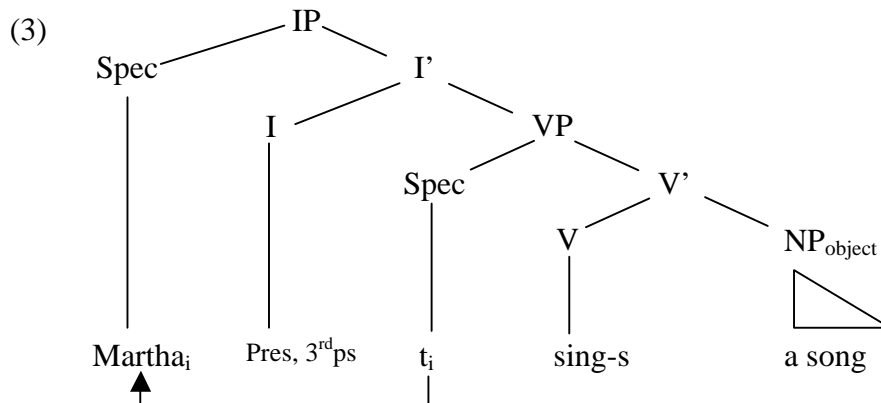

In Spanish, on the other hand, I is rich enough to be considered lexical, VP being L-marked.¹¹⁷ Since the internal subject in [Spec VP] is governed by I, movement of the subject to preverbal position, that is [Spec IP], is then optional. Therefore, in declarative sentences, both VOS/VSO and SVO orders are possible depending on whether movement of the subject to [Spec IP] takes place, rendering the SVO order in (4):

¹¹⁵ Following Chomsky (1986), we can distinguish between structural Case (accusative and nominative), which is assigned solely in terms of S-Structure configuration, from inherent Case (including genitive) which is associated with theta-marking. That is, inherent Case is assigned by alpha to an NP only if alpha theta-marks the NP.

¹¹⁶ The Case filter states that every phonetically realized NP must be assigned (abstract) Case.

¹¹⁷ In the sense that the VP is governed by I and theta-marked by it, too. In order to refer to the special relation that is established between a lexical item and the complement which it governs and theta-marks, Chomsky (1986) introduces the term L-marking: A L-marks B iff A is a lexical category that theta-governs B. In the case of IP, it is said to be defective in that its head is not a word, but only a group of syntactic features [+/- Tense, +/- Agr]; nevertheless, the richness of inflection in Spanish is what may give support to certain lexical properties in various categories (Haegeman 1994).

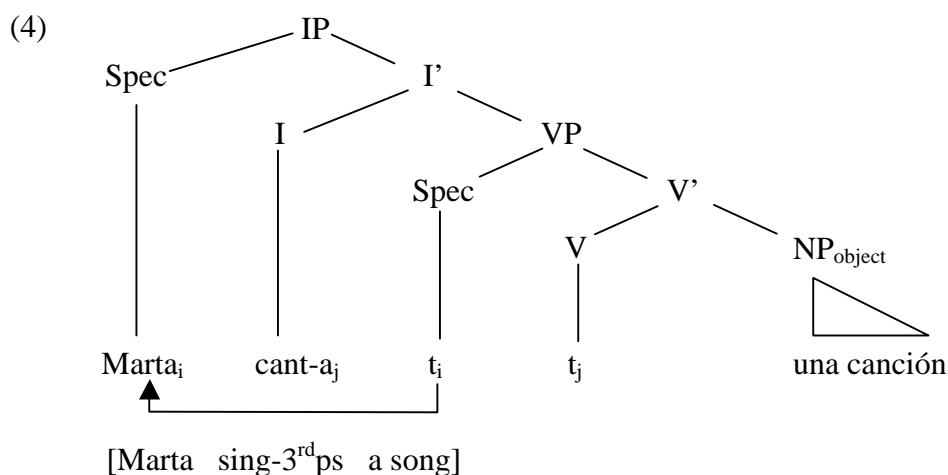

or whether such movement, although optional, does not take place, thus resulting in a VOS/VSO order as in (5):¹¹⁸

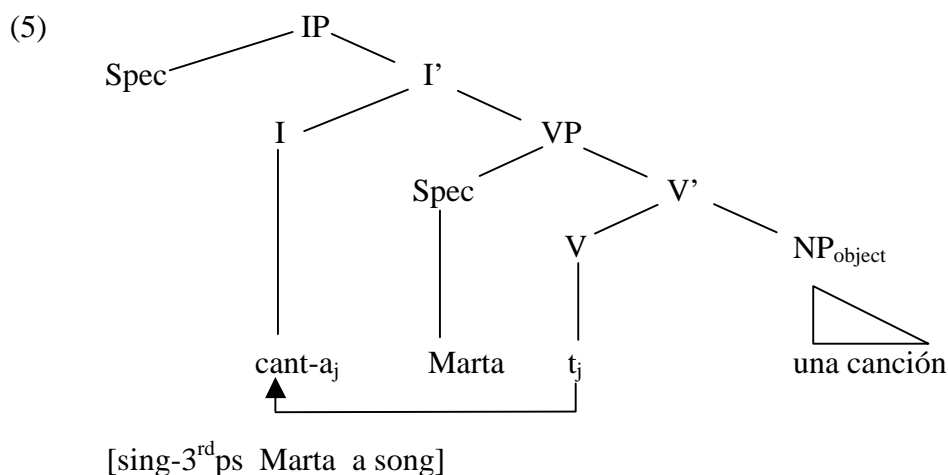

The VP-internal subject hypothesis rests on two assumptions. The first one is that there is parametric variation in the overt syntax, since languages differ with respect to the mechanisms of Case assignment by I (which can either be by agreement or through lexical I). The second assumption is the degree of optionality in the

¹¹⁸ Notice that the subject is generated in preverbal position but Spanish presents V-to-I movement, the result being the postverbal position of the subject. Authors like Contreras (1991) defend that the subject in Spanish is generated as an adjunct unordered with respect to the predicate. We will explore this proposal later.

application of movement rules in certain cases (as the Spanish examples in (4) and (5) reveal).

Under the PP framework, these assumptions pose no problem and are, therefore, commonly accepted. Nevertheless, when adopting a minimalist perspective, such assumptions have to be reviewed, since they do have inappropriate results. As we mentioned in the previous chapter, the MP proposes a system in which parametric variation must be reduced to morphological properties of lexical items and in which movement must be considered legitimate if and only if it is necessary for convergence (the principles of economy operate in this respect).

If we are to account for the different behavior of subjects and their positions in English and in Spanish in minimalist terms, we have to incorporate economy principles as well as all other minimalist concepts in an analysis that embraces both the similarities and differences in English and Spanish, and that captures the related issues of subjects and agreement features. Such an analysis will have to account for the two possibilities present in Spanish without attributing it to the optionality of movement. Within the MP, these three numerations (SVO, VOS, VSO) should be analyzed as arrangements that are independent of each other (none deriving from the other) while having some common universal structure, since we are dealing with a universal SVO order (Kayne 1994, Chomsky 1999).

2.1.2. Agreement Features

There is a clear relationship between verbs and their subjects, and agreement features play a central role in it.¹¹⁹ In order to explain how this relationship is attained and which type of relationship we are being confronted with, certain issues have to be mentioned. We will look at the presence *versus* the existence of Agr, its relationship with other projections and the shared characteristics regarding Agr in any language.

The node I, as its label suggests, dominates all verbal inflection, i.e. including Person and Number properties.¹²⁰ The IP layer contains an EPP feature and a set of Case and phi-features. Concentrating on subject-verb agreement, the inflectional properties of verbs of the languages under analysis are illustrated in (6):

(6)	Juan lee la carta ¹²¹	John reads the letter	Jean lit la lettre
	leo la carta	I read the letter	je lis la lettre
	mis amigos leen la carta	my friends read the letter	mes amis lisent la lettre

In Spanish and French, the verb ending (in bold type) is determined by the Person Number of the subject: I and subject NP agree with respect to Person and Number

¹¹⁹ In the MP, *agree* operation is analyzed in terms of feature movement (*attract*) and matching. In *minimalist inquiries* (Chomsky 1998), matching is identity and, thus, *attract* is dispensed with.

¹²⁰ As previously discussed, and in accordance to Pollock's (1989) split inflection hypothesis, agreement features are to be contained in an independent node, AgrP. This node will then disappear in the MP.

¹²¹ Martínez (1999) points out that agreement in Spanish implies, in cases such as that in (6), the existence of two types of subjects: 1) morphological subject or inflection, that is, the Person/Number information contained in the verbal ending, together with other verbal features and the actual lexical content of the verb (the root); and 2) lexical subject, that is, the NP or pronoun.

features, that is, the EPP feature in IP is checked by the raising of an Agr head to T (Alexiadou and Anagnostopoulou 1998 and Kempchinsky 1999). In English there is little overt agreement. Thus, Spanish is said to have a richer paradigm than English in which Person and Number agreement often do not have any morphological realization.

An interesting case emerges when dealing with Person agreement markers (phi-features), which have direct bearing on the null-subject parameter. In fact, one immediately observes that the possibility of omitting a pronoun subject correlates with the other property of the languages examined, especially when comparing English with Spanish and French, as in (7):

(7)	English	Spanish	French
	1 st ps I speak	(yo) hablo	(moi,) je parle ¹²² [parl]
	2 nd ps you speak	(tú) hablas	(toi,) tu parles [parl]
	3 rd ps he speaks	(él) habla ¹²³	(lui,) il parle [parl]
	1 st pp we speak	(nosotros) hablamos	(nous,) nous parlons
	2 nd pp you speak	(vosotros) habláis	(vous,) vous parlez
	3 rd pp they speak	(ellos) hablan	(ils,) ils parlent [parl]
	2 forms	6 forms	5 forms (3 phonetic)

As we said before, in the case of both Spanish and French, almost every Number/Person combination has a different ending. As a result, the inflectional paradigm distinguishes all six Persons uniquely, especially in Spanish. There is no possibility of confusion: the ending of the verb immediately identifies the subject.

For an analysis on the contrast between the presence and the absence of pronouns in Spanish as a null-subject language, see also Fernández Soriano (1989).

¹²² Subject personal pronouns are not clitics in Spanish but they may be so in French: je is a *pro*-clitic, while moi is not. See Kayne (1975) for an analysis of French weak pronouns as clitics. Also Bosque (1990).

These types of inflectional systems are generally considered to be rich.¹²⁴

In contrast, the English system has only one distinctive form, the third Person singular. All other Persons are unmarked morphologically, resulting in a bare system, (which is also identical to the imperative and the infinitive). The overt agreement properties of English verbs are therefore heavily reduced.

It has traditionally been assumed that the inflectional paradigm of the language correlates with the null-subject parameter (Perlmutter 1971, Taraldsen 1980, Rizzi 1986, and Jaeggli and Safir 1989). Languages that have rich inflection are often null-subject languages.¹²⁵ This correlation is expected. When the verb inflection is rich, the content of the subject can be recovered, and the pronoun supposedly adds no information. In languages which have poor inflection, the verbal f-features (endings) do not suffice to recover the content of the subject and, thus, a pronoun is needed. A rich inflection can identify an empty category in the subject position, as in (8), while a poor inflection fails to do so:

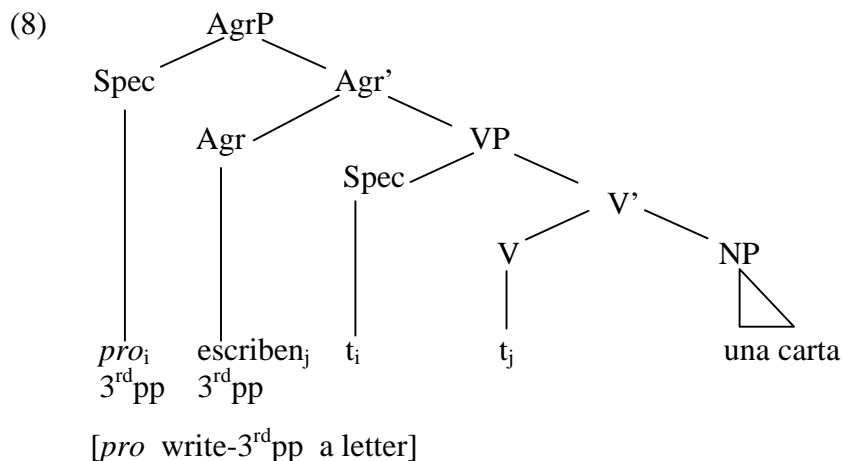

¹²³ Third Person agreement (-a) is considered by some authors as the non-Person (Martínez 1999), default agreement or Ø agreement (Kato 1999). This would be relevant for the analysis of expletives in the following chapter.

¹²⁴ As we will discuss later, under Hoekstra and Hyams (1995) analysis, English, like Dutch, presents Number distinctions, while Spanish, in the same way as Italian, displays Person distinctions.

In other words, the grammatical features of the subject can be recovered from those of I, specifically from Agr, in languages with rich verb inflection. In English, these features are not recoverable because Agr is too poor.

Nevertheless, though the overt realization of agreement for Person and Number is restricted in English, it is assumed that there is abstract agreement, which is often not morphologically realized. Thus, the difference between English, on the one hand, and languages such as Spanish or French, on the other, does not lie in an absence *versus* presence of Agr, but rather in a stronger or weaker morphological realization of Agr.

Agreement is, therefore, a collection of phi-features, and, moreover, when dealing with specifier-head agreement, head (I) and specifier (NP) share Number, Gender and Person features. Languages vary with respect to the extent to which agreement between specifier and head is morphologically realized. Along these lines and following Pollock's (1989) and Chomsky's parametrization of Agr as [+/- strong], Contreras (1991) proposes the [+/- lexical] dimension of Agr to account for the difference that exists between English and French, on the one hand, and Spanish on the other. This double dimension in Agr features gives way to the following hierarchy in (9):

- (9) English [- strong], [- lexical] agreement
 French [+ strong], [- lexical] agreement
 Spanish [+ strong], [+ lexical] agreement

¹²⁵Gilligan (1987) studies a sample of 100 languages from various language families and reports that there are 76 languages with agreement which allow for the subject pronoun to be absent. The

Therefore, this double-dimension agreement groups Spanish differently from French, which is like an English-type language in terms of the [-lexical] feature.

At the same time, these Agr features are used by Contreras (1991) to provide a unified explanation of issues such as 1) the possibility or impossibility of topicalization; 2) the presence or absence of postverbal subjects; 3) the presence or absence of null pronominal subjects; and 4) the nature of preverbal subjects. These derived consequences are going to reflect the different behavior of English and Spanish.¹²⁶

Once the presence of agreement features is recognized, either overtly or covertly, and following Pollock's (1989) split inflection hypothesis, it follows naturally that Tense and Agreement are independent heads; T and Agr head then separate maximal projections.

The specific order between these two projections is an issue that we have to deal with. As we mentioned earlier, while for Pollock the structure is [Spec T Agr VP], for Belletti (1990) Agr precedes T. In an attempt to unify these proposals, Chomsky (1995) proposes the existence of two Agr elements in IP, each a collection of phi-features, one involved in subject agreement and subject Case, the other in object agreement and object Case. As presented in the previous chapter, AgrS and AgrO are redefined in minimalist terms; namely, this double agreement system is substituted by a double-Spec one. AgrO is thus turned into the light verb *v*, while AgrS is blended with T, nominative Case and Tense being both checked in T. The tree diagram in (10) shows the different projections:

remaining 17 languages without agreement allow the subject to be absent.

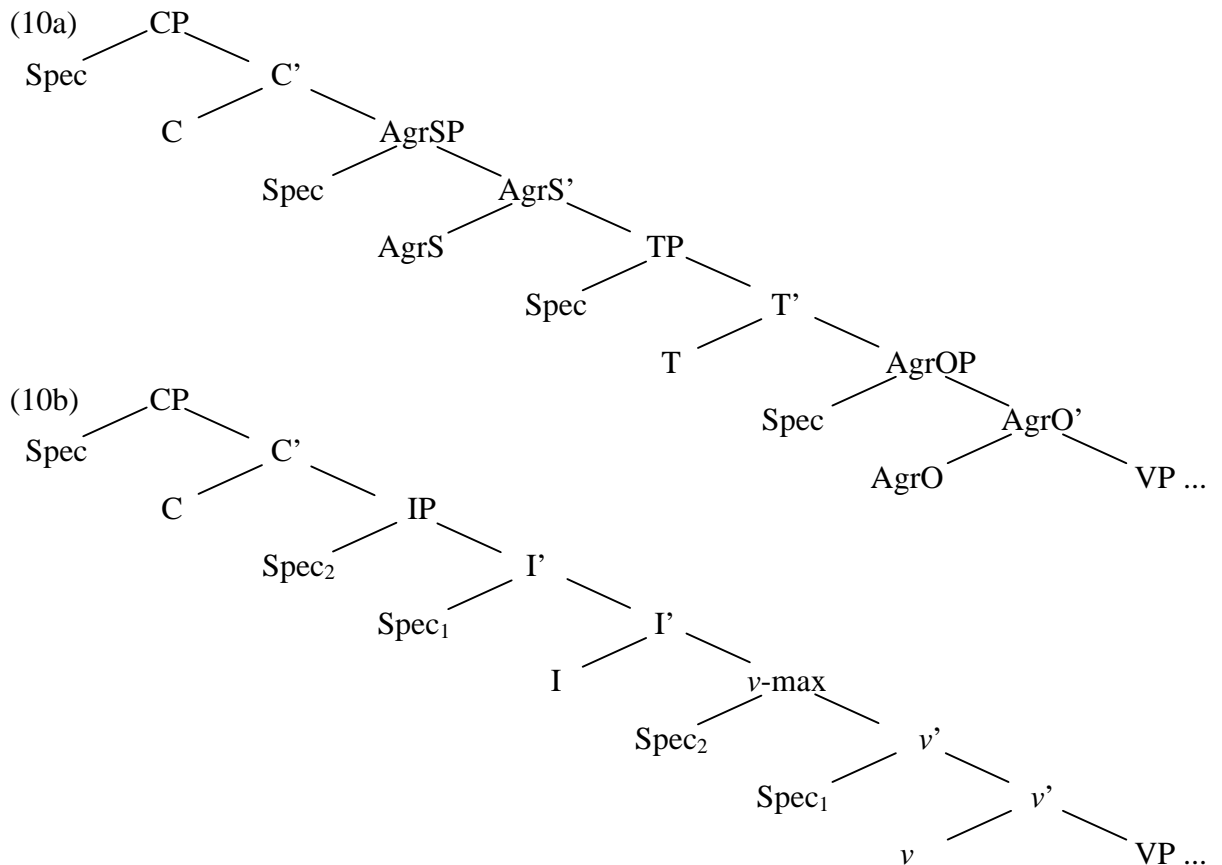

Chomsky (1995) points out that the notations AgrS and AgrO are mnemonics and that there is only one element Agr, a collection of phi-features. The V head of VP fuses with the heads AgrO, T and AgrS, and, at least by LF, V with its affixes has raised to eliminate all traces not c-commanded by their antecedents. What presents parametric variation among languages is the point in the derivation in which an operation takes place, if overtly (before LF) or covertly (after LF), always under economy principles. Thus, unless a language requires the movement to be overt (as is the case in English due to its impoverished subject-verb morphological agreement), it should take place at the least cost, that is, covertly after LF (as is the case in Spanish with a strong AgrS).

¹²⁶ Contreras' analysis does not include French.

When concentrating on AgrS and Tense and the relationship that exists between the two, another double analysis is assumed (parallel to the English/Spanish one regarding SV and VS orders) in terms of the relative position they occupy in the tree diagram. Their relative order will bring about differences as far as word order is concerned. In fact, since Ouhalla's (1991) influential work, it has been widely accepted that there is parametric variation in the order of the inflectional heads of a sentence. This order has direct impact on the word-order possibilities of the subject. Ouhalla (1991) claims that for SVO languages Tense morphemes appear under AgrS morphemes, while the reverse order takes place in the cases of VSO languages such as Arabic, where AgrS morphemes appear inside Tense morphemes. This is reflected in the tree diagrams in (11):

(11) a. VSO languages (Arabic)

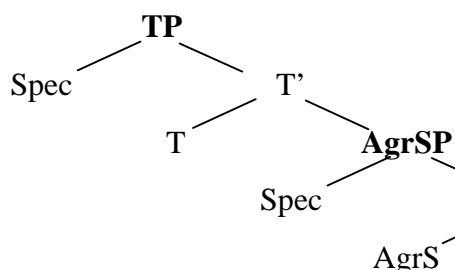

b. SVO languages

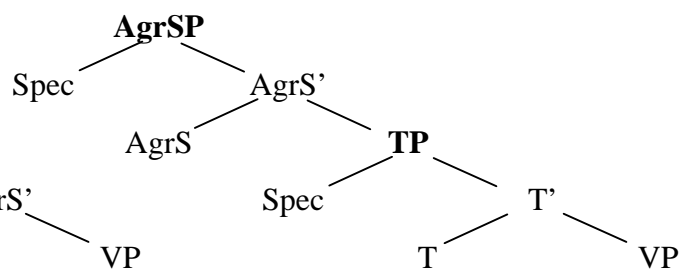

As the organization in the tree diagrams suggests, this difference in the order of inflectional morphemes (Tense and Agr) reflects a basic typological distinction: in SVO languages AgrS is higher than T and in VSO languages, T is higher than AgrS.¹²⁷

¹²⁷ This difference in order of inflectional heads follows the mirror principle (Baker 1985, 1988), according to which morphological derivations must directly reflect syntactic derivations (and *vice versa*). Namely, the verb features (Tense and phi-features markers) in a Spanish form such as that in (i):
 (i) cant-a-ba-mos

Given the fact that the languages under analysis here are all SVO languages, this analysis may pose no problem for us: both English and Spanish, are SVO-type languages, in that respect. Nevertheless, approaches such as this one create a problem for the theory underlying our analysis.

In the MP, as we have said, a verb does not pick up morphological features in the course of the derivation (as it was maintained in the PP theory). Instead, a verb is inserted in the structure fully inflected and its verbal features are matched with those of the functional categories; these features, if the derivation is to converge and not crash, are deleted or erased when checked off. In this sense, morphological derivations need not directly reflect the order of syntactic derivations and that is why, under minimalist premises, there is no parametric difference in the syntax.¹²⁸ Rather, the structure of a sentence, of any sentence, conforms universally to the one in which AgrSP dominates TP as in (12):

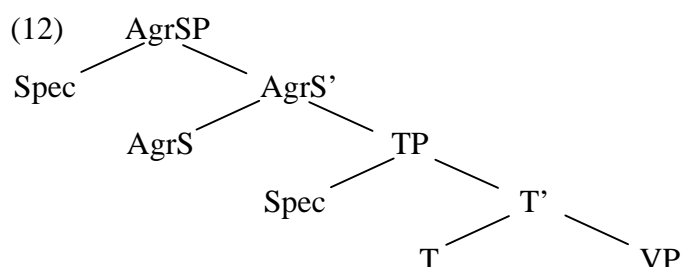

[*sing*-theme vowel-past tense-1stpp]

where Tense markers (-ba-) and phi-features (-mos) contained in V (cantar, [to sing]) are checked in the corresponding nodes that are higher in the tree, first TP, Tense markers coming first and then, higher up, AgrS (with the corresponding phi-features -mos). Following Baker's principle, the order of affixes is the order that would be derived by raising the verb to each dominating functional head in turn and affixing that functional head to the verb. Within checking theory, features are checked in the order in which they were provided to the verb via affixation in the lexicon, the features' innermost affix being checked first. See also Halle and Marantz (1993) for violations of a strict mirror principle. Against the concept of the mirror principle, see Alsina (1999).

¹²⁸ The link between morphological derivations and syntactic derivations is clear, since the features are the ones responsible for movement operations (checking relations) and these features depend on the morphological richness of the language. The idea here is that this link does not necessarily have to be one of total correspondence.

This dispenses with Ouhalla's (1991) parameter. Regardless of the type of language, either SVO or VSO, they share a common diagram, but they do not necessarily share the features.

To summarize, agreement features do exist and their placement in the sequence of projections is fixed. Both assumptions affect any type of language, either SVO (which encompasses among others English, Spanish and French) or VSO (with Arabic as an example). They also apply irrespective of the type of structure we are confronted with, either SVO (which we find in English, Spanish and French) or VS (which is present in Spanish and not in the two other SVO languages).¹²⁹ The existence of agreement is common to them all; what is parametric is the way this is framed in the syntax, in the specific relationship between subjects and verbs in every language.¹³⁰

2.1.2.1 Null-subject Languages and Non-configurational Languages: Pronominal Agreement

As it has been previously said, rich agreement correlates with the possibility of having null subjects and, therefore, with null-subject languages. Nevertheless, these are not the only types of languages that present this characteristic. Various linguists have demonstrated that at least a certain degree of parallelism exists in this respect between null-subject languages and the so-called non-configurational or polysynthetic languages.

¹²⁹ The difference between the SV/VS orders in Spanish and Arabic is that in Arabic subject-verb agreement depends on linear word order, such that preverbal subjects agree with the verb in Person features while postverbal subjects do not. In Spanish, no such difference in terms of agreement relationship is generally found and subjects typically agree with their verbs. There are also cases of loss of agreement in Spanish in raising constructions, sentences with collective subjects and in expletive constructions.

¹³⁰ See the following section for the proposal of Agr as a clitic.

Jelinek (1984) stresses the similarity between these language-types and describes it in the following way: rich agreement, relative freedom of word order and the possibility of having null arguments.

Along similar lines, Baker (1995) proposes a polysynthesis parameter in which the relevant set of morphemes are agreement morphemes (pronominal affixes) and incorporated roots.¹³¹ Rizzi (1982) already pointed out that inflection in null-subject languages can be specified as pronominal. This optional specification, when it occurs, causes I to show properties similar to those of clitic elements, to receive a pronominal interpretation, and finally, to absorb the nominative Case of the verb in order to avoid a Case filter violation. If, on the other hand, I is specified as [-pronominal], its properties would be the same as those of verbal inflection in non-null-subject languages like English.¹³²

According to the polysynthesis parameter, every argument of a head element must be related to a morpheme in the word which contains the head. In this way, the parameter expresses the need for syntactic argument relationships to be expressed morphologically in some languages. This also implies that the theta-criterion is satisfied morphologically rather than syntactically.

The proposals put forth by Jelinek (1984) and Baker (1995), on the one hand, and by Rizzi (1982), on the other, differ only with respect to one basic claim, namely, whether agreement is always pronominal or just optionally specified as such.¹³³ The examples in (13) and (14) show the case of Mohawk, a non-configurational language, and Spanish, a null-subject language.¹³⁴

¹³¹ Jelinek's (1984) non-configurational languages equal non-configurational head-marking languages for Baker (1995).

¹³² See Kato (1999).

¹³³ See also Barbosa (1996, 1997a, 1007b).

¹³⁴ Examples taken from Baker (1995).

- (13) a. Sak **ra-nuhwe'**-s ako-[a]tyad'tawi
 [Sak masc.sing-like-HAB fem-sing-poss-dress]
 [Sak likes her dress]
- b. *pro*_{subject} **Ra-nuhwe'**-s *pro*_{object}
 [∅ masc.sing-like-HAB ∅]
 [he likes it]

- (14) a. Marta **escribe** poemas preciosos
 [Marta write-3rdps poems beautiful]
 [Marta writes beautiful poems]
- b. *pro*_{subject} los **escribe**
 [∅ them write-3rdps]
 [she writes them]

The pronominal specification of rich agreement correlates with the freedom of word order and with the possibility of dropping verbal arguments. The crucial difference between null-subject languages and polysynthetic languages is, therefore, that in null-subject languages, as in (14), this correlation applies only to external arguments, i.e. to subjects. Polysynthetic languages, as in (13), license not only the external argument as a null element, but also any other verbal argument, as a result of the Case and theta-role absorption properties of these languages. In this way, as (13b) shows, not only the subject but also the object are dropped.

[talk-3rdpp-past [about the students] after of that them fight-3rdpp-past with them]
[they talked about students after they got angry with them]

These facts show that a plural DP binds a 3rdpp pronoun or agreement by default.

However, when the plural DP is associated with 1stpp or 2ndpp subject agreement, the binding effects are the opposite. The plural DP associated with 1stpp subject agreement can only be bound with 1stpp in the adjunct clause but not with a 3rdpp, as in (18) and (19):

(18) *[los estudiantes]_i salimos de la reunión después de que los_i acusaran
[[the students] leave-1stpp-past of the meeting after that them accuse-3rdpp-past]
[the students left the meeting after they were accused]

(19) [los estudiantes]_i salimos de la reunión después de que nos_i acusaran
[[the students] leave-1stpp-past of the meeting after that us accuse-3rdpp-past]
[we, the students, left the meeting after we were accused]

Therefore, the examples above point to the conclusion that the appearance of agreement on the verb is crucial in evaluating the possible antecedent for a pronoun. This could only be shown in a language that allows different agreement possibilities for the same DP as shown above. When the DP appears not to be associated with any agreement element, as in the case of the objects los estudiantes [the students] in (16) and (17), it can only bind a default 3rdp pronoun. When the DP is associated with an agreement morpheme, as in the subjects los estudiantes [the students] in (18) and (19), it can only bind a pronoun whose Person specification matches the agreement associated with the DP binder.¹³⁵

¹³⁵ As Ordóñez (1997) points out, the conclusion is rather puzzling for those theories that claim that *pro* and subject DPs might have, in part, the same distribution (e.g. Chomsky 1982 and Rizzi 1986).

2.1.3. Subjects: Adjunct / Argument Dichotomy

The relationship between verbs and subjects is also seen in terms of movement (checking relations) and, in this sense, the nature of the position occupied by subjects is to be discussed.

Among the NP positions in a syntactic representation, we distinguish positions in which arguments are generated and to which grammatical functions such as subject and object are assigned, from those positions that are occupied by adjuncts. The former are called A-positions (argument positions) and the latter A-bar positions (A' or \bar{A} positions; non-argument positions). The distinction between A- and A-bar positions plays a central role in the theory of movement and other modules of grammar.

Adjunction is defined as an operation in which a new node XP2 is created and dominates the original XP1. Adjunction respects phrase structure theory: the new constituent XP2 is headed by X, and the node XP2 created by adjunction is binary branching, etc. The notion of adjunct is functional (relational) not categorial, thus, there is no categorial symbol Spec, but rather a relation specifier-of. The tree diagram in (20) shows the adjunction of ZP to XP, and the one in (21) refers to an argument relationship between XP and YP:

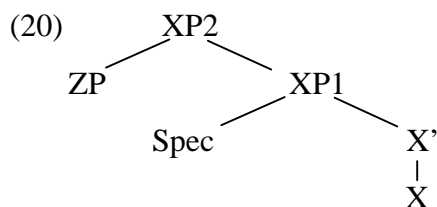

From that perspective, it is harder to express how the different agreement changes affect the binding possibilities of these DPs.

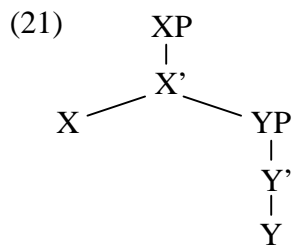

The above seems to suggest that, when opposing subjects and adjuncts, there is a clear distinction between A-positions, in which we find subjects, and A-bar positions where adjuncts are to be placed; each position is defined on clearly-cut terms and states basic differences between the categories. Nevertheless, this is far from being the case and while there used to be a complete separation between A-positions and A-bar positions, there is now a tendency to see at least some kind of connection between these two categories, subject and adjunct.¹³⁶ Chomsky (1995), for example, states that adjuncts like subjects are not complements.

On the argument/adjunct distinction, Contreras (1991) pinpoints two main differences between these categories: 1) their position: arguments occupy only complement and specifier positions and adjuncts never do; and 2) the assignment of theta-roles: theta-roles are assigned only to argument positions. In spite of this, Contreras (1991) also argues that the correlations between theta-positions and argument positions may not be that straight-forward since there are positions that are technically adjuncts (i.e., certain subjects) and yet must be theta-marked.

Along the same lines, Olarrea (1996) claims, as we will see in the next section, that at least one type of preverbal subjects should be analyzed as clitic left-dislocated constructions (CLLD). In that sense, these specific preverbal subjects are base-generated adjuncts to the maximal inflectional projection and, since they

¹³⁶ See Haegeman's (1994) and Haegeman and Guéron's (1999) treatment of this topic.

are adjuncts, they do not occupy an A-position but rather an A-bar position.¹³⁷ Furthermore, these preverbal subjects are coindexed with an empty pronominal which, in this case, is located in argument position. With respect to other types of subjects, this argument position is also the one where postverbal or null subjects are located. As a result, sentences with preverbal subjects and sentences with postverbal subjects are the result of different numerations; apart from the adjunct nature of some preverbal subjects, in the former case there is a *pro* element in the numeration that is absent in the latter.¹³⁸

The adjunct/argument dichotomy is, therefore, crucial for the analysis of subjects. Since not all subjects are located in an argument position, an A-bar NP position also has to be considered.

2.1.3.1. Null-subject Languages and Non-configurational Languages: Subjects as Adjuncts

As in the case of agreement, certain parallelisms are also present between these two groups of languages regarding the status of subjects as adjuncts.

Non-configurational languages, such as Mohawk and Warlpiri, are characterized among other properties by showing rich agreement morphology on the verb. Jelinek (1984) was the first to argue that in non-configurational languages argument NPs have the status of adjuncts. She also notices the similarities between languages like Warlpiri and null-subject languages like Spanish, an analysis that is

¹³⁷ The preverbal slot occupied by preverbal subjects in Spanish will behave as a non-argument position, a non L-related position in early minimalist terms (see also Uribe-Etxebarria 1992 and Vallduví 1992).

¹³⁸ Olarrea (1996) states that not all preverbal subjects are left dislocated; preverbal negative subjects, non-referential quantifiers and contrastive focus phrases must occupy a different position from other preverbal constituents. Following previous work by Uriagereka (1994), Olarrea (1996) maintains that this position is the specifier of a focus phrase.

also supported by Olarrea (1996). In both types of languages, the use of independent pronouns basically indicates emphatic contrastive reference. Also those sentences with an independent pronoun in addition to a pronominal affix (agreement in Romance) or a clitic are the marked constructions.¹³⁹

(22) (YO) sé lo que pasó, (no tú)

[(ME) know-1stps it that happened, (not you)]

Jelinek (1984) claims that, due to the specialized function of independent pronouns as adjuncts in these languages, some verbs that do not allow contrasts in referential emphasis must exclude independent pronouns as adjuncts. As Olarrea (1996) indicates, this is the case of weather verbs in Spanish:

(23) llueve / *él/ella/ello llueve

[∅ rains]

[he/she/it rains]

Since the subject of verbs like llover/to rain is non-referential, an independent pronoun used for emphatic referential contrast cannot be adjoined to AgrSP. This is also predicted by Olarrea's analysis of subjects as CLLD constructions, since the licensing of the subject as an adjunct is constrained by a referentiality condition on both the resumptive pronominal and the dislocated element:

(24) nosotros_i vamos pro_i al cine

[we_i go-1stpp resumptive-pronominal_i to the theatre]

¹³⁹ See last section for marked/unmarked word order. Also see Kato (1999) for weak/strong pronominal paradigms in Spanish.

As Baker (1995) defends, in polysynthetic languages full NPs show all the characteristics of CLLD constructions as described in Cinque (1990), listed here as follows:

1) the dislocated NP is adjoined to IP, as in (25):

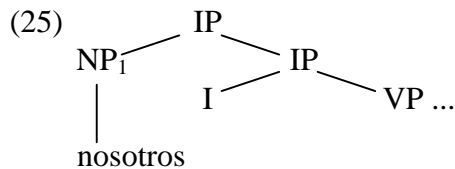

Contrary to the adjunction structure in (25), the English example in (26) shows the movement operation of the subject from [Spec VP] where it is generated:

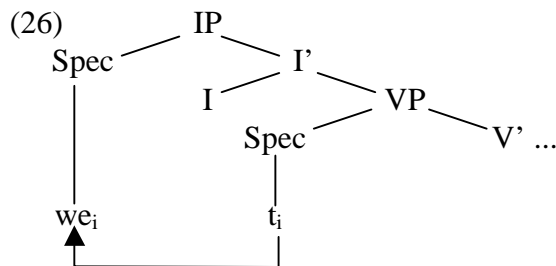

2) the number of CLLD constituents in a sentence is not restricted to one, as in (27):

(27) al cine nosotros vamos todos los fines de semana
 [to the cinema we go every weekend]

3) phrases other than NPs can be dislocated:

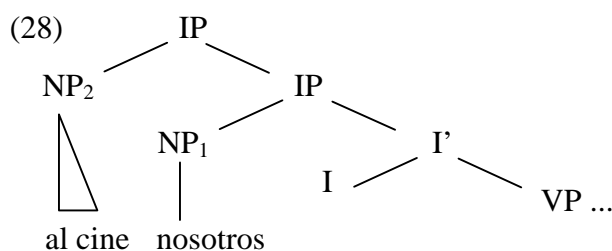

4) the dislocated NP is coindexed with a null pronominal argument *pro* or, following Kato's (1999), [+pronominal] agreement, as in (29):

(29) *nosotros_i va-mos_i pro_i al cine*
 [we go to the cinema]

5) the NP and the pronominal (either *pro* or [+pronominal] agreement) form an A-bar chain since the position of the dislocated NP, being an adjunct, is an A-bar position, that is, a position to which theta roles are not assigned.

6) this chain does not have the properties of movement. In our example, *nosotros* is adjoined to IP, not moved from [Spec VP] to [Spec IP], as shown in (25) *versus* (26).

7) the dislocated NP must be intrinsically referential. In fact, *nosotros* belongs to the Spanish strong pronominal paradigm.

Therefore, the difference between Spanish and Mohawk with respect to subject positions is that while in Spanish subjects may be adjuncts (when they appear in preverbal position), as in (30), in Mohawk they must always appear in adjunct positions, as in (30) and (31a):

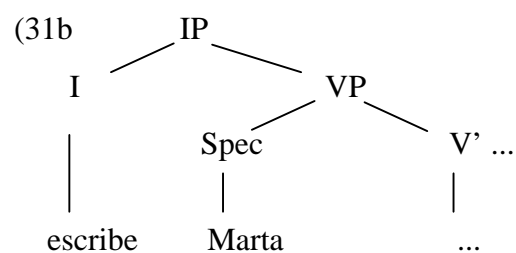
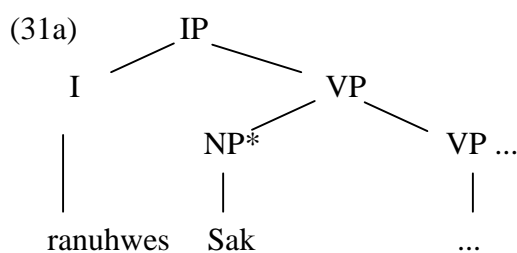
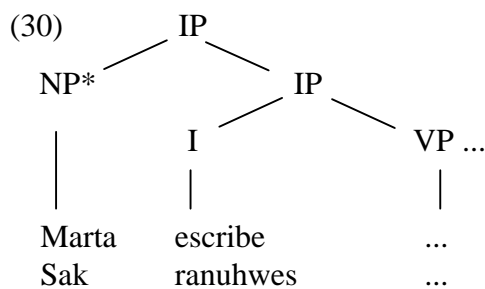

The examples in (30) indicate that preverbal subjects are adjuncts, both in Spanish and in Mohawk. On the contrary, while postverbal subjects in Mohawk are also adjuncts, as in (31a), postverbal subjects in Spanish are arguments, as in (31b). In sections 2.3. and 2.4., we will deal with preverbal and postverbal subjects in a more detailed way.

2.1.3.2. Doubling Structure: DP and Agreement Clitic

Ordóñez (1997) adopts the idea that Person agreement is a clitic and then proposes that the relation between the Agr and the DP is the same kind of relation established between a DP and a clitic: both are instances of clitic doubling. In doing so, Ordóñez (1997) together with Ordóñez and Treviño (1999) adopt the specific proposal about clitic doubling made by Torrego (in progress) and Uriagereka (1995). Torrego has proposed that the clitics (in Ordóñez and Treviño's proposal, Agr) head a DP in the spirit of Postal (1974). This DP is also integrated by the doubling DP, which merges with the head to form what we can call a big DP, as illustrated in (32):



The feature agreement between the doubled DP and the clitic agreement is resolved internally to the big DP, which is in an argumental position in D-structures. Since the clitic is the head of the DP, it will be also the element that absorbs the nominative Case from the tense specification. They will then be transmitted by Spec-head to the doubled DP. Following Alexiadou and Anagnostopoulou (1996),

we could also say that clitic agreement gets Case by incorporating to T. Tense assigns its Case to the big DP by being in a very local relation with the upper Spec of the VP in which the subject argument is situated, as in (33):¹⁴⁰

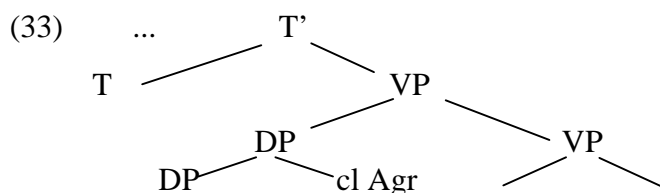

Ordóñez (1997) takes the position that the clitic is the only element that can satisfy theta-role assignment and Case for the subject argument. Thus, he follows the line of thought established by Jelinek (1984) that in some languages the real arguments are the agreement morphemes, which she also takes to be a clitic. This defining property is encoded in the parameter which distinguishes non-polysynthetic languages from polysynthetic ones.¹⁴¹ Along Ordóñez's (1997) lines, there are good reasons to classify Spanish into the first group with respect to the subject agreement. Thus, we start to understand why Spanish does not pattern with canonical SVO (English) or canonical VSO (Irish and Arabic), which is also what Contreras' (1991) and Zubizarreta's (1994) analyses imply.

From Ordóñez and Treviño's (1999) perspective, the DP is the doubling element of a clitic argument, and it is completely optional. Its presence or absence is irrelevant for the discharge of the theta-role or the assignment of nominative Case to subjects. Lexical DPs are licensed by being in a Spec-head relation with the clitic agreement inside the big DP, and they will inherit all their properties in that

¹⁴⁰ For further discussion see Ordóñez (1997).

way. The position of the doubled DP is purely motivated by pragmatic reasons since it plays no role for Case. In Spanish, subjects would have the option of moving to neutral phrase (NeutP) or to focus phrase (FocP) which implies that subjects are always moved out of the VP.

Ordóñez and Treviño (1999) assumed that there is no inflectional projection Agr and that verbs in Spanish move beyond VP to TP/IP in order to incorporate to the subject clitic agreement, as in (34):

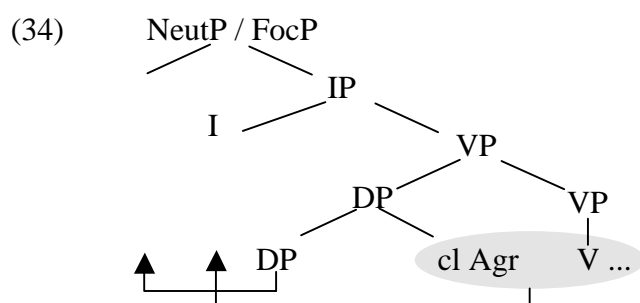

So any movement of the doubling DP subject past the V + T/I + clitic Agr must be driven by considerations of semantic discourse interpretation such as is typical for the case of left dislocations of O_{ds} and O_{is} .¹⁴²

2.1.4. The Issue of Terminology

We will now provide a quick view on the analysis of the different word-order possibilities that are allowed in languages such as English and Spanish regarding subject-verb positions. This will reveal the terminological disagreement

¹⁴¹ Baker (1995) encodes the parameter in a different fashion. He proposes that arguments in these languages have to be coindexed to a morpheme (see his morphological visibility condition), even though the morpheme is not the real argument.

¹⁴² One of the ideas defended by Ordóñez (1997) is that preverbal subjects and preverbal objects have similar syntactic behavior, as we have previously explained.

that exists in the literature regarding word-order phenomena. Depending on the author, the terms may change, as well as their coverage with respect to these phenomena. Hence, it is not only a terminological problem, but also a problem of inclusion *versus* exclusion of different structures under certain labels. We will not try to solve such uncertainty, but only review some of the various positions in order to attain a precise and clear idea of the structures that concern us: subject-verb relations and their various orderings.

2.1.4.1. Rivero (1978, 1980)

For Rivero, a distinction has to be made between topicalization and left-dislocation phenomena. Rivero concentrates mainly on objects, but her analysis also applies to subjects.

Left-dislocated sentences have an NP set off by commas at the beginning of a clause. This NP occupies the topic position TopP. Also a pronoun or another NP appears and it is anaphorically related to the phrase in TopP. The example in (35) shows a left-dislocated object:

(35) **esta película**, no creo que **la** hayan visto

[this movie, not think-1stps that it have-3rdpp seen]

[this movie, I don't think that they have seen it]

Topicalizations have an initial NP set off by commas, as in the case of left dislocation. But, as opposed to left dislocation, a movement operation takes place: the initial NP moves from its original position to CP (complementizer phrase). This

movement creates a gap in the NP original position, so that no clitic pronoun appears in this case, as in (36):¹⁴³

- (36) dinero, no creo que tengan
 [money, not think-1stps that have-3rdpp]
 [money, I don't think they have]

2.1.4.2. Contreras (1976, 1991)

Left dislocation, as it is usually referred to in English terminology, is called topicalization by Contreras (1976).¹⁴⁴ Contreras (1991) states that the comparison of the phenomenon referred to as topicalization, and illustrated by examples such as those in (37), reveals the fact that in Spanish topicalization, as such, does not exist. What we have in Spanish is always left dislocation:¹⁴⁵

- | | | |
|------|--|-----|
| (37) | a. this lesson Mary knows very well | OSV |
| | b. *esta lección María sabe muy bien | OSV |
| | [_{IP} esta lección _i [_{IP} María _k [_{VP} [_{VP} sabe <i>t</i> _i muy bien] <i>t</i> _k]]] | |
| | c. *esta lección sabe María muy bien | OVS |
| | d. *esta lección sabe muy bien María | OVS |

¹⁴³ As we will see, for Olarrea (1996) left-dislocated constructions are not the result of movement but are rather base-generated. The only topicalizations that are the result of movement are those in which the dislocated element is a bare NP; these are the type of examples analyzed by Rivero (1978), as in (36) above.

¹⁴⁴ Again, to what Hernanz and Brucart (1987) refer to as thematization (*tematización*, using the Spanish terminology).

¹⁴⁵ Contreras (1991) does not distinguish between those constructions in which no clitic can appear and other constructions in which the clitic does or may appear. Olarrea (1996) captures this difference by distinguishing between, on the one hand, focus constructions and, on the other, left dislocation (LD) and clitic left dislocation (CLLD) structures, respectively.

Under Contreras' (1991) analysis, both esta lección (O_d) and María (S) are technically adjuncts and, following the revised version of relativized minimality that Contreras proposes, María prevents esta lección from antecedent-governing t_i , since María is a closer governor for t_i than esta lección. Therefore, the empty category principle is violated, thus yielding the sentence ungrammatical.¹⁴⁶

In left-dislocated structures, the preverbal position of the leftmost constituent is never a result of movement but rather a constituent base-generated in that position. To account for the different nature of these structures, Contreras (1991) argues that in examples such as the ones in (38), at least two facts point to this conclusion:

(38) a. dinero, no creo que tengan []

[money, not think-1stps that have-3rdpp]

[money, I don't think they have]

b. dinero, no conozco a nadie que tenga *e* mucho

[money, not know-1stps to nobody that have-3rdps *e* much]

[money, I don't know anybody that has a lot]

(38) c. en cuanto a dinero, no creo que tengan

[as far as money, not think-1stps that have-3rdpp]

[as far as money, I don't think they have]

¹⁴⁶ Contreras (1991) follows Rochemont's (1989) analysis of topicalization as adjunction.

On the one hand, the fact that the gap in (38a) can occur inside a syntactic island, as in (38b), indicates that it is not a trace. On the other hand, the structure allows for the type of introductory material that characterizes left dislocations.¹⁴⁷ Furthermore, Contreras (1991) claims that the absence of a resumptive clitic can be due to the fact that the left-dislocated constituent is endowed, following Suárez (1988), with a nonspecific feature/nature.

Therefore, as opposed to English, Spanish lacks topicalization structures in the sense that in languages like English the left-dislocated element is the result of the application of movement (alpha-move); in Spanish what has been termed as topicalization is thus reanalyzed as adjunction (no movement operation being undertaken/conducted), as in (39):

- (39) las rosas, me encantan esas flores
 [the roses, me love-3rdpp these flowers]
 [roses, I love these flowers]

As Contreras (1991) argues, topicalization with an overt subject is not possible in Spanish. According to him, the same restriction seems to apply to structures with null pronominal subjects, as shown in the following example (40):

- (40) *esa lección sabe muy bien *pro*
 [this lesson know-3rdps very well *pro*]
 [this lesson he knows very well]

¹⁴⁷ In Spanish, phrases such as en cuanto a, por lo que afecta a, hablando de, equivalent to English

Contreras argues that *pro* is technically an adjunct and that it prevents government of the object trace by its antecedent adjoined to IP:

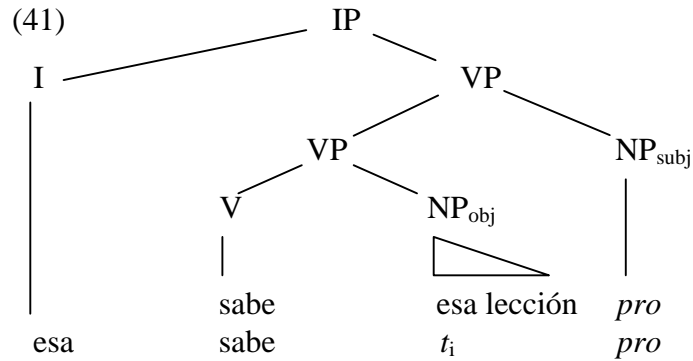

On the contrary, Liceras (personal communication) explains the grammaticality of (40) in terms of emphasis, as reflected in the following example in (42):

- | | | |
|------|--------------------------------|---|
| (42) | ¿ <u>qué</u> sabe muy bien? | ESA lección sabe muy bien <i>pro</i> |
| | | ESA LECCIÓN sabe muy bien <i>pro</i> |
| | [what does he know very well?] | [THIS lesson know-3 rd ps very well <i>pro</i>] |
| | | [THIS LESSON know3rps very well <i>pro</i>] |

The question in (42) for which this sentence constitutes the answer makes it possible to emphasize the object. Emphasis can be placed either in the determiner esa or in the NP esa lección, with contrastive value (i.e. this lesson and not any other).

as for and as far as, function as expressions triggering left-dislocation (Contreras 1983).

2.1.4.3. Hernanz and Brucart (1987)

Hernanz and Brucart (1987) stress the non-existence of terminological agreement to term these phenomena neither in Spanish nor in English. In fact, what they propose is to distinguish between, on the one hand, normal SVO sentences as in (43) and, on the other hand, thematization (*tematización*) and rhematization (*rematización*), illustrated in the examples in (44) and (45):

(43) María detesta las acelgas

[María hate-3rdps the silver-beets]

(44) las acelgas María las detesta (thematization)

(45) LAS ACELGAS detesta María (rhematization, dislocation)

They maintain that pragmatics is reflected in the syntax so that, for the thematization/rhematization division, they make use of the dichotomy between old information (theme) and new information (rheme). They also add to this division the selection processes that are involved in the generation of these structures. These processes dictate the order in which the two constituents will appear in the final structure of the sentence, that is, whether the theme precedes the rheme (a theme/rheme order called objective order) or whether the rheme precedes the theme (a rheme/theme order called subjective order).

In cases such as the one in (44), the theme las acelgas appears in the periphery of the sentence, which is mainly associated with the initial position, but not necessarily. The element theme may be the object as in (44) but also the subject as in (46):

(46) María, lo sabe todo (thematization, theme = subject)

[María, it know-3rdps all]

[María, she knows it all]

In this case, and in order to stress the thematic subject, certain strategies may be used. Following Contreras (1983), they mention the presence of a pause between the subject and the rest of the sentence or the presence of phrases of the type en cuanto a/as for, respecto a/with respect to, as in (47):

(47) en cuanto a María, lo sabe todo

[as for María, it know-3rdps all]

[as for María, she knows it all]

A different intonational pattern can also be used as a strategy to mark the thematic subject element. As opposed to rhematization, which is a structure derived from a movement operation, thematization includes an element, theme, which is generated within theme phrase.¹⁴⁸

The rhematization process is illustrated in (45) with the rheme (las acelgas) placed in a prominent position within the sentence. Not only objects, but also subjects can be rhematized. From the different processes that may carry out this operation Hernanz and Brucart concentrate on dislocation phenomena. Dislocation, which implies movement, is included within the global phenomenon of

¹⁴⁸ Campos and Zampini (1990), in their analysis of objects, argue that left dislocation (Rivero 1980) / thematization (Hernanz and Brucart 1987) does not imply movement when the dislocated

LD structures, such as (48), are equivalent to what Hernanz and Brucart term discursive anaphor. Thematization parallels CLLD structures in (49), and rhematization phenomena are defined in Olarrea's terminology as focus fronting constructions, as in (50).¹⁵⁰

When focusing on the position of the subject as occupying this absolute initial position, Olarrea (1996) defends that Spanish sentences with preverbal subjects have all the characteristic properties of what Cinque (1990) calls clitic left-dislocation constructions (that have neither a pause nor a special intonation), as in (51), where the empty element is the equivalent to lo in (52b) below:

- (51) Juan_i [e]_i fue a la fiesta
 [John [e] went to the party]

He adds that these properties differ in certain important aspects from those of ordinary left dislocation found in English.¹⁵¹

Olarrea (1996) also points out the terminological disagreement in the literature with respect to the classification and description of the properties of left-dislocated structures in Spanish. In any case, and under his terminology (LD,

¹⁴⁹ He makes use of the terminology from Cinque (1990) (LD and CLLD) and from Uriagereka (1992) (focus fronting constructions).

¹⁵⁰ Licerias (personal communication) points out that in examples like that in (50), we may be dealing with two different structures: one that makes use of a special intonation and a pause between the focus-element/rheme and the rest of the sentence, as in (i); and a second one in which no pause appears, as in (ii):

(i) esas flores, compré ayer [these flowers, buy-1stps-past yesterday]
 (ii) ESAS FLORES compré ayer [THESE FLOWERS buy-1stps-past yesterday]

In the first case, no movement operation takes place and no emphasis is used. The second is perhaps the result of movement.

¹⁵¹ Cinque (1981) already pointed out the different treatment that structures such as those in (i) and (ii) should receive:

CLLD) or Hernanz and Brucart's (1987) (discursive anaphor, thematization), these structures are clearly opposed to topicalization/rhematization processes (dislocation, in the case of Hernanz and Brucart 1987).¹⁵²

There exist important differences between LD and CLLD constructions. What follows summarizes the differences between the two constructions taking into consideration pragmatic, stylistic and syntactic issues:

1) both LD and CLLD constructions involve a left-dislocated element, as in (52):

- (52) a. Juan_i , no me acuerdo de él_i
 [John, not me remember-1stps of him]
 [John, I don't remember him]
- b. a Juan_i lo_i vimos en la fiesta
 [to John him see-1stpp-past in the party]
 [John we saw him at the party]

The difference between them is that while LD can only have NPs as dislocated elements, CLLD allow for any phrasal type to be dislocated, such as the PP a Juan in (52b).¹⁵³

-
- (i) María_i , ésa_i , sí que está como una cabra [María, she is nuts indeed]
 (ii) ¿María_i ? lo sabe todo [e]_i [María? it know-3rdps all] [María? she knows it all]

¹⁵² On focus, see Rochemont (1986), Campos (1986) and Campus and Zampini (1990).

¹⁵³ When dealing with subjects, the fact that phrases other than NPs can be clitic left dislocated does not apply. It may be necessary to point out, though, that CPs and some PPs can be preverbal subjects in Spanish:

- (i) [entre Juan y Pedro] arreglarán el coche (PP)
 [[between Juan and Pedro] mend-3rdpp-future the car]
 (ii) [que tú no vayas a terminar la tesis] es increíble (CP)
 [[that you are not going to finish your thesis] is unbelievable]

Nevertheless, we may argue as well that in the cases of (i) and (ii) there is an empty subject and that the structures between square brackets are adjuncts that are located in a position higher than [Spec IP].

2) the dislocated element is co-referent with another element in the sentence as in (53), but while LD requires a phrase or a pronoun (either a clitic or a tonic pronoun), CLLD can only have an empty pronominal (licensed by agreement or by a clitic; since Spanish has no subject clitics, the presence of strong agreement is what licenses the empty resumptive pronoun, as in (51) above):¹⁵⁴

- (53) a. John Coltrane_i , ese saxofonista_i me encanta
 [John Coltrane, this saxophonist me love-3rdps]
 [John Coltrane, I love this saxophonist]
- b. en Juan_i no es posible confiar [e]_i
 [in John not is possible trust-infinitive [e]]
 [it is not possible to trust in John]

So LDs may or may not be constructed with a clitic, while CLLDs require the obligatory presence of a clitic or the corresponding strong agreement (in the case of subjects) in order to license the gap.

3) Topicalizing expressions are possible in LD, as in (54a), but cannot be used in CLLD, as the ungrammaticality in (54b) shows, since there is no pause between the dislocated constituent and the rest of the structure:

- (54) a. en cuanto a Ismael_i , él_i no va a suspender el examen
 [as for Ismael, he not go-3rdps to fail the exam]
 [as for Ismael, he is not going to fail the exam]

¹⁵⁴ The parallelisms between strong Agr and clitics in the Romance Languages have been pointed out in several works since Rizzi (1982).

b. *en cuanto a Juan_i lo_i vi ayer¹⁵⁵

[as for John him see-1stps-past yesterday]

[as for John I saw him yesterday]

4) LD constituents take absolute first position, while CLLD ones can be freely embedded as the ungrammaticality in (55a) *versus* the grammaticality in (55b) shows:¹⁵⁶

(55) a. *todos piensan que Ismael_i , él_i no va a suspender el examen

[all think that Ismael, he not go-3rdps to fail the exam]

[everybody thinks that Ismael, he is not going to fail the exam]

b. todos piensan que de Juan_i no deberíamos hablar [e]

[all think that about John not should-1stpp talk [e]]

[everybody thinks that we should not talk about John]

5) The examples in (52a) and (54a) show that identity of Case and subcategorization between the dislocated element and the co-referential element is not necessary in LD. The example in (56) shows a mismatch between the Case features of the co-referential element (en él), in which the preposition en marks

¹⁵⁵ The ungrammaticality of (54b) contrasts with the grammaticality of (i) where a pause turns the structures into an LD ones:

(i) en cuanto a Juan_i , lo_i vi ayer [as of Juan, him see-1stps-past yesterday]
hablando de Juan_i , lo_i vi ayer [talking about Juan, him see-1stps-past yesterday]
en cuanto al vino_i , te lo_i prohibieron con razón [as far as the wine, no wonder you mustn't take it]

¹⁵⁶ Absolute first position makes reference to the fact that LD constituents cannot be embedded although they can be preceded by topicalizing expressions, as in (54a). Notice also that LD constituents will appear in embedded position in those constructions in Spanish in which a complementizer can be followed by a wh-word:

(i) me pregunto que quién trajo el vino [I wonder that who brought the wine]
[I wonder who brought the wine]
(ii) me pregunto que a Juan_i quién lo_i llamó [I wonder that to John, who him called]
[I wonder who called John]

accusative Case, and those of the dislocated element (Juan) with nominative Case (as opposed to the oblique accusative Case of en Juan):¹⁵⁷

- (56) Juan_i, estaba pensando en él_i en este momento
[Juan, be-past-1stps thinking in him in this moment]
[Juan, I was thinking of him at this moment]

On the contrary, in CLLD, there is an obligatory connectivity (Cinque 1990) between the two items, as in (57) where they both show accusative Case features:

- (57) a nosotros_i no nos_i han dicho nada
[to us not us have-3rdpp said nothing]
[they have not said anything to us]

7) In both constructions more than one constituent can be dislocated, with the difference that LD structures require a conjoined phrase:

- (58) a. en cuanto a María y a su marido_{i+j}, es evidente que él_j le_i pega a ella_i
[as for Mary and her husband, is evident that he her hits to her]
b. a María_i esa película no le_i interesa
[to Mary this movie not her interest-3rdps]
[Mary she is not interested in this movie]

¹⁵⁷ The lack of connectivity in LD structures can be shown by the possibility of having a left-dislocated element that does not agree in Gender and Number with the co-referential element, as in (i):

(i) el ordenador_i, yo odio esas máquinas infernales_i
[the computer, I hate these hideous machines]

8) The types of constituents involved in each construction vary as well. In LD these are adjuncts to CP and in CLLD they are adjuncts to AgrSP, as in (59a) and (59b):

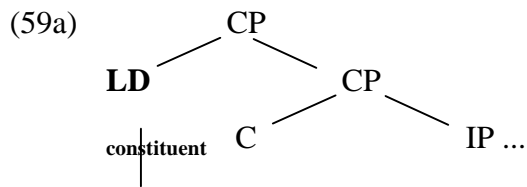

Juan

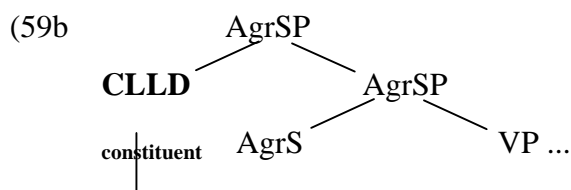

✓

Both LD and CLLD are base-generated (they are adjuncts), so no movement applies.

9) In both cases there is the possibility of a preceding wh-word as in (60):

(60) a. en cuanto a Juan_i, ¿**qué** quiere comer hoy ese chico_i?

[as far as John, what want-3rdps eat today?]

b. ¿a Juan_i **qué** le_i pasa?

[to John what him happen-3rdps?]

[what happens to John?]

But in the case of LD, as shown in (60a), a long pause is required between the constituent and the wh-word, the LD structure being external to the interrogative sentence.¹⁵⁸

10) Constituents from which extraction is not possible are referred to as islands. Regarding island constraints, LD is insensitive both to strong and weak islands, as in (61):

- (61) a. en cuanto a ese trabajo_i, [no puedo [aceptar la idea [de que ya lo_i ha conseguido]]]
 [as for that job, [not can-1stps [accept the idea [of that already it have-3rdps got]]]
 b. María_i, [me pregunto [que quién la_i ha visto]]
 [María, me wonder-1stps that who her have-3rdps seen]

LDs in (61) allow the constituents ese trabajo and María to be coreferential with the clitics lo and la respectively, both located in the lowest clause. In the case of ese trabajo, the corresponding clitic is separated by three barriers from its coreferential LD structure and, therefore, the term strong island is used. Since the NP María in (61b) is separated from its clitic by two barriers, we are dealing with a weak island.

As opposed to LD, CLLD is only insensitive to weak islands, as in (62):

- (62) a. ?ya te he dicho que [el dinero_i [no puedo [aceptar la idea [de que ya lo_i han conseguido]]]]
 [already you have-1stps told that [the money [not can-1stps [accept the idea [of

¹⁵⁸ The assumption in the case of CLLD constituents in interrogatives is that there is covert I-to-C movement in Spanish and that this movement is blocked after Spell-Out if any preverbal adjunct is present (Olarrea 1996).

that already it have-3rdpp got]]]]

[I have already told you that [the money [I can't [accept the idea [that they
have already got it]]]]

- (62) b. a esos espías_i [no sé [cómo se puede saber [quién los_i traicionó]]]
[to these spies not know-1stps how can-3rdps-impersonal know who them
betray-3rdps-past]

In (62a), the CLLD constituent el dinero is more strongly felt to be apart from its corresponding clitic (strong island), while the weak island in (62b) poses no problem for the relationship between the constituent a esos espías and its corresponding clitic los.

2.1.4.5. Zubizarreta (1998, 1999)

Zubizarreta's (1998, 1999) work concentrates on the relationship between syntax and prosody.¹⁵⁹ Within this basic assumption, the notions of theme and focus relate to different grammatical fields and are particularly relevant to the description and analysis of the various possible word orders.

Zubizarreta distinguishes between sentence theme and discourse theme.¹⁶⁰ Sentence theme can be associated to different positions within the sentence, including subject, direct object, indirect object, etc. There exist two types of constructions with peripheral themes located to the left of the sentence: hanging topic, as in (63), which parallels thematic structures as discussed by Hernanz and

¹⁵⁹ On the relationship between intonation and syntax, see also Hatakeyama's (1998) analysis of two types of topicalization in English (topic-topicalization and focus-topicalization).

Brucart (1987) and which may imply a change of theme from the previous context; and left dislocation, as in (64), much in the manner of Rivero (1980):

(63) en cuanto al libro, está encima de la estantería

[as for the book, is on top of the shelf]

(64) el libro, me encantaría leerlo

[the book, me would-1stps love read-infinitive-it]

As it has been traditionally assumed (Chomsky 1971, 1976, Jackendoff 1972, 1978), for Zubizarreta the focus is also the non-presupposed part of the sentence (rheme for Hernanz and Brucart). Prosodic prominence playing a crucial role in the identification of the focus in a sentence, Zubizarreta distinguishes between neutral focus (identified by means of an interrogative context) and contrastive focus.¹⁶¹ Contrastive focus has two main characteristics: 1) it negates the value attributed to a certain variable (this negation may be explicit or implicit); and 2) it assigns an alternative value to this variable.

Zubizarreta stresses the ties between focus and its intonational properties. According to her, from among the different types of tonal accents, the nuclear accent is the one associated with the word being the most prominent one in perceptive terms. Within nuclear accent, we distinguish between neutral accent and emphatic accent. The relationships between neutral accent and focus, and between emphatic accent and focus are expressed by Zubizarreta (1999) in terms of two

¹⁶⁰ The terms in Spanish are *tema oracional* (sentence theme), *tema discursivo* (discourse theme) and *tema vinculante* (hanging topic).

¹⁶¹ See Motta (1996) for a phonetic study of contrastive/neutral focus.

different laws or principles. In the first case, focus/nuclear accent, the marked-Foc constituent must dominate the nuclear accent, as in (65):

- (65) se comió un ratón el gato VOS
[eat-3rdps-past a mouse-O_d the cat-S]

In the second case, focus/emphatic accent, the word carrying emphatic accent must be dominated by all phrases that are marked with the feature Foc (that is, all the phrases that are part of the focus), as in (66):

- (66) JUAN vio a María
[JOHN see-3rdps-past to Mary]
[JOHN saw Mary]

Focus can also be placed in initial position as in (67):¹⁶²

- (67) a. EL GATO se comió un ratón
[THE CAT him eat-3rdps-past a mouse]
[THE CAT ate a mouse]
b. LAS ACELGAS detesta María
[SILVER-BEETS hate-3rdps Mary]

In this case, and as opposed to left-dislocation phenomena, no clitic appears.

¹⁶² Focus fronting in Olarrea's (1996) terminology and dislocation in Hernanz and Brucar's (1987).

Table (I) captures some of the most important terms used by the different authors that have been mentioned:

Table I: word-order terminology			
	this lesson Mary knows well las acelgas María las detesta	las rosas, me encantan <i>esas flores</i>	las acelgas detesta María
Rivero (1978, 1980)	left dislocation (TopP)		topicalization (mov)
Contreras (1976, 1991)	left dislocation in Spanish (adjunction) topicalization in English (mov)		
Hernanz and Brucart (1987)	thematization (ThemeP)	discursive anaphor	dislocation (rhematization) (mov)
Olarrea (1996)	CLLD (AgrSP)	LD (CP)	focus fronting (mov)
Zubizarreta (1998, 1999)	theme		focus

This review on the relative sequence of elements in the sentence not only illustrates the terminological disagreement, but also reveals a crucial point for the analysis of these syntactic/pragmatic processes: the resulting structures may be a product either of movement or of adjunction (base-generated).

The terminology we will be using for our analysis will focus on the notions of pre-verbal and post-verbal subjects as broader terms that refer to the position the subject occupies in the sentence. In the case of pre-verbal subjects in Spanish, we will make use of Cinque's (1990) and Olarrea's (1996) terms: clitic left dislocation (CLLD) and left dislocation (LD) structures. Therefore, the analysis of preverbal subjects in Spanish will be based on adjunction rather than on movement

procedures. For pre-verbal subjects in English, we will take a movement approach. Post-verbal subjects in Spanish are related to movement procedures, both in the case of neutral and marked subjects.

2.2. Subject / Verb *versus* Verb / Subject Orders

When considering the relative order of subject and verb, we are confronted with two possibilities; the subject may precede the verb (SV order) or it may follow it (VS order). While both options are available in the Spanish language, as the examples in (68) reveal, only the SV option is allowed both in English and in French, as in (69):¹⁶³

(68) tus amigos leen la carta

leen la carta tus amigos

(69) your friends read the letter tes amis lisent la lettre

*read the letter your friends *lisent la lettre tes amis

As we have already mentioned, if we add the object to the subject-verb complex, a double possibility is again present in Spanish in the case of VS order. The object may precede the subject, as in VOS order, or it may follow it, thus rendering a VSO order. Therefore, we are confronted with one possibility in English and French, SVO order, while in Spanish we may find both SVO and VSO/VOS orders. Regardless of the different options available in any of these three languages, it is a fact that we are always dealing with what has traditionally been termed SVO-type languages.

Uribe-Etxebarria (1992) points out that in Spanish a quantified subject in postverbal position may have either a wide or a narrow scope, as in (70); but when we are dealing with a preverbal subject, it can only have narrow scope, as in (71):

(70) ¿a quién dices que amaba cada senador? narrow or wide scope; ambiguity
[to whom say-2ndps that love-3rdps-past each senator_{subject}]

(71) ¿a quién dices que **cada senador** amaba? narrow scope; no ambiguity
[to whom say-2ndps that each senator love-3rdps-past]

In (70), if the subject has wide scope, the sentence will be interpreted as follows: every senator can love a different person, the one each senator chooses to love. In (71), the subject can only have narrow scope and so the sentence can be rephrased as follows: all senators love the same person. This option, with the subject having narrow scope, can also apply to the postverbal subject in (71).

English subjects are always preverbal. As May (1985) shows, and as opposed to the Spanish example in (71), English preverbal subjects can have either narrow or wide scope, as in (72):

(72) whom do you say that every senator loved?

Comparing the previous Spanish examples to the English ones in (73), we arrive at an interesting parallelism:¹⁶⁴

¹⁶³ As we note in the following section, the use of postverbal subjects in French is very limited and, in any case, more restricted than in Spanish.

¹⁶⁴ Examples taken from Lasnik and Uriagereka (1988).

- (73) a. someone thinks that Mary solved every problem
 b. someone thinks that **every problem** Mary solved

The example in (73a) reveals an SVO order in the subordinate clause. In this case the direct object every problem can either have a narrow or a wide scope. In (73b), the topicalization of the object applies in the subordinate clause and thus the object is located before the subject. Here there is no ambiguity in every problem which can only have narrow scope; that is, the sentence is interpreted as follows: Mary solved all problems. Even if in (73) we are dealing with the subject preceding or following the direct object (rather than the verb as in (70) and (71)), preverbal subjects in Spanish and topicalization in English have some common properties (i.e. restriction to only narrow scope) and are in a way analogous processes. This implies that, preverbal subjects in Spanish and in English should be treated differently.

In an attempt to capture the differences between English and Spanish, Contreras (1991) defends a different type of analysis for the subject position in SVO orders. In the case of English, the subject must raise to [Spec IP] for Case assignment, thus rendering the unmarked order in (74):

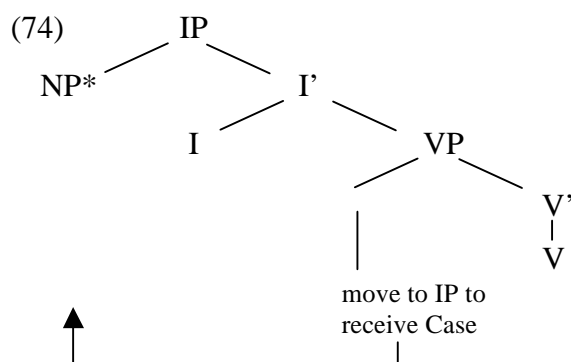

or by base generation (no movement being involved in this case), as in (77):

(77) [IP no sé [CP cómo se puede saber [CP cuánto ganan **esos futbolistas**]]]

[IP **esos futbolistas**_i [IP no sé [CP cómo se puede saber [CP cuánto ganan *pro*_i]]]]

[these football players I don't know how one can know how much they make]

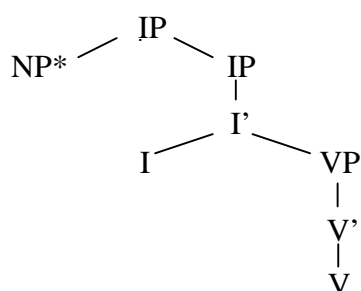

Notice that in any case, both in Spanish and in English, Contreras' (1991) and Zagana's (1982) VP-internal subject hypothesis applies.

Since the subject is placed in IP via adjunction, Spanish VS orders (either VOS or VSO) result therefore from V-to-I movement applied to D-structure; no subject postponing applies. It is rather the verb that moves past the position in which the subject is placed. Here Contreras (1991) follows the proposals by Emonds (1976) and Pollock (1989) according to which V-to-I movement occurs with all verbs in Spanish and French but only with have and be in English.

Taking these previous proposals as the starting point, minimalist approaches to this topic have also accounted for subjects and their order in the sentence.

Olarrea (1996), based on the above-mentioned work by Contreras (1991), considers preverbal subjects as instances of clitic left-dislocation (in the sense of Cinque 1990). This means that in these cases we are not dealing with movement operations but rather with processes of adjunction. As proposed by Chomsky

(1993), the phenomena of agreement and nominative Case in Spanish are manifestations of a structural relation between a functional head and its specifier position. The nominal categorial features of AgrS in Spanish are, following Olarrea (1996), uniformly [-strong] while the verbal categorial features of this inflectional head are [+strong], a characteristic of null-subject languages.¹⁶⁵ It is then a distinction between the different features contained in AgrS, those that are nominal (which are [-strong]), and those that are verbal (which are, as in any null-subject language, [+strong]).

Agreement features, therefore, are going to be the connecting point in the present analysis. But, at the same time, we will need to go beyond the [+/- strong] agreement feature dichotomy in order to provide a unified account of both English and Spanish which includes both their universal features and their peculiarities.

We will focus first on preverbal subjects and then on postverbal subjects.

2.3. Preverbal Subjects

The presence of preverbal subjects renders SV order, irrespective of the language under analysis. In the case of English and Spanish, SV order needs to receive a different treatment in each language, in the sense that, although both languages allow for this type of ordering, the operations involved in each case are different. Therefore, preverbal subjects may have different pragmatic and stylistic characteristics in each language.

¹⁶⁵ Under minimalist assumptions, it will then be possible to explain the phenomenon traditionally called free subject inversion, which is characteristic of null-subject languages, without resorting to the existence of categorial features of non-substantive head specified with two different values for a given language, therefore abandoning the theoretical disjunction in the mechanisms of Case assignment.

2.3.1. Clitic Left-dislocated Constructions and Preverbal Subjects

Some recent analyses of preverbal subjects in Spanish focus on the nature of subjects as adjuncts and their position as left-dislocated items. Left-dislocated structures are constructions in which the leftmost constituent occupies a position of prominence. As for the classification and description of the properties of left-dislocated structures, there have been many different analyses with a variety of terminology, as has been previously pointed out.

The nature of preverbal subjects as instances of left dislocation has been defended by several authors. Among them, Ordóñez (1997) states that preverbal subjects have to be left dislocated and establishes a link between the obligatory left-dislocated nature of subjects and the relatively rich inflectional system of the language (of many Romance languages).¹⁶⁶

By the same token, Olarrea (1996) claims that preverbal subjects are clitic left-dislocated constructions, following Cinque (1990). He analyzes subjects as base-generated adjuncts to the maximal inflectional projection, as in (78):

- (78) [_{AgrSP} María_i [_{AgrSP} [_{AgrS'} sabe_k [_{TP} t_k' [_{VP} pro_i [_{V'} t_k la lección]]]]]
[Mary know-3rdps the lesson]

These adjuncts, as the previous example reveals, are coindexed with an empty pronominal which is in argument position. Preverbal subjects, therefore, do not

¹⁶⁶ Here Ordóñez (1997) follows Taraldsen (1992a, 1992b). His theory also complies with Kayne's (1994) antisymmetry proposal.

occupy an argument position, while the *pro* element in the numeration with which preverbal subjects are coindexed is indeed in an A-position.¹⁶⁷

This conception of preverbal subjects differs greatly from previous analyses such as the one defended by Contreras (1991) that we have previously mentioned. Consider the example in (79):

- (79) [IP esos futbolistas_i [IP no sé [C_P cómo se puede saber [C_P cuánto dinero ganan pro_i]]]]
 [these football players I don't know how one can know how much money they make]

For Olarrea (1996), the deeply embedded subject *pro_i* is not subjacent to the NP that is adjoined to IP (esos futbolistas), since both CPs in (79) are barriers. Therefore, this sentence cannot be the result of movement and the most embedded subject cannot be a trace, as Contreras (1991) defended for one type of adjunction. On the contrary, it has to be a resumptive empty pronominal and the initial phrase has to be left dislocated.¹⁶⁸ Compare the example in (79) with the previous one in (78), repeated here as (80):

- (80) [IP **María_i** [IP sabe_k [VP **t_i** [V' t_k la lección]]]]

Nevertheless, not all preverbal subjects are left dislocated. Olarrea (1996) differentiates among three types of preverbal subjects in Spanish: negative subjects,

¹⁶⁷ As we said before, we adhere to the minimalist *v*-max analysis. Respecting Olarrea's (1996) proposal and other analyses which do not include the *v*-max projection, we do not incorporate this projection here.

¹⁶⁸ As for Case and agreement properties, Olarrea (1996) adopts Taraldsen's (1992a, 1992b) position that agreement, specifically Person agreement, should be considered a clitic and an argument of the verb. As we will see later, this proposal also explains certain mismatches in Person specification.

referential non-negative subjects and non-referential non-negative subjects. The main difference between the three is that only referential non-negative subjects are CLLD constructions and are, therefore, licensed as adjuncts to IP. Thus, preverbal negative subjects, non-referential quantifiers and contrastive focus phrases must occupy a different position from other preverbal constituents. This position is the specifier of a negation phrase ([Spec NegP]) in the case of negative subjects. Other types of preverbal subjects (preverbal non-referential non-negative subjects) are in a focus phrase ([Spec FocP]), following Uriagereka (1994), as focus movement constituents. We will deal with these proposals separately.¹⁶⁹

2.3.2. The Position of Preverbal Subjects

Preverbal subjects in English are located in [Spec IP]; this position is projected in English but not in Spanish. English preverbal subjects move to IP from their base-generated position in [Spec VP], as in (81):

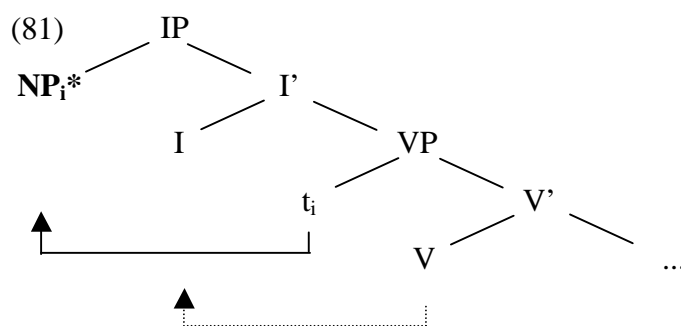

Since verb movement from VP to IP is covert in English (Pollock 1989), it follows that subjects in English are always preverbal.¹⁷⁰

¹⁶⁹ Preverbal negative subjects are not included in our analysis. Olarrea (1996) defends that postverbal subjects and negative subjects occupy the same position.

¹⁷⁰ As we said in chapter one, MI reduces basic operations to *merge* and *agree* which are based on feature matching. The operation that takes place between V and IP is a *set-merge* one (Chomsky 1998, 1999).

The case of Spanish is somewhat different in that [Spec IP] is no projected (Contreras 1991) and preverbal subjects are analyzed as adjuncts. Both Contreras (1991, 1994) and Olarrea (1996) agree on the basic idea that preverbal subjects as clitic left-dislocated constructions are base-generated adjuncts to the maximal inflectional projection. As a consequence, preverbal subjects do not occupy an A-position. They are adjuncts to IP.¹⁷¹ Nevertheless, the theoretical framework they use is different and, therefore, they provide different analyses.

By using negation, Contreras shows that in Spanish the subject never occupies [Spec AgrSP]. Laka (1990) and Bosque (1992) defend that what differentiates English from Spanish is the relative order of the functional heads with respect to negation. In Spanish, NegP dominates AgrSP, while in English NegP dominates TP, as illustrated in (82) (for both authors, preverbal subjects occupy the canonical [Spec AgrSP]):

- (82) a. English: [CP [AgrSP [NegP [TP [VP ...]]]]]
 b. Spanish: [CP [NegP [AgrSP [TP [VP ...]]]]]

Based on this distinction but departing from Laka and Bosque's interpretation, Contreras (1994) argues then that the contrast in (83) shows that the subject never occupies [Spec AgrSP] in Spanish since preverbal subjects precede negation:

- (83) a. creo que María no ha trabajado hoy
 [believe-1stps that Mary not have-3rdps worked today]

¹⁷¹ This analysis predicts the different distribution of preverbal subjects and empty pronominal subjects in Spanish, as will be shown later.

[I believe that Mary has not worked today]

b. *creo que María ha no trabajado hoy

[believe-1stps that Mary have-3rdps not worked today]

In (83a) the subject follows the complementizer and precedes negation. The sentence is grammatical. But if negation follows the Aux in AgrSP, the sentence is ungrammatical. It can be claimed that, at least in negative sentences, the preverbal subject is not in [Spec AgrSP] but rather higher in the structure.

Contreras (1991, 1994) also defends that AgrS (I) in Spanish is [+lexical], and therefore projects no specifier, according to Fukui and Speas' (1986) proposal. Subjects are generated as VP-internal adjuncts whose order is not specified with respect to the predicate.¹⁷² The internal subject receives nominative Case under government by I, since I L-marks the higher VP. As we said before, Spanish SVO order is then the result of adjunction to IP. This adjunction of the NP subject to IP can be produced either by movement, as in (84a), or by base-generation, as in the case of long movement of the subject in (84b) (Contreras 1991):

(84) a. [_{IP} María_i [_{IP} sabe_k [_{VP} [_{VP} t_k la lección] t_i]]]]

b. [_{IP} esos futbolistas_i [_{IP} no sé [_{CP} cómo se puede saber [_{CP} cuánto dinero ganan pro_i]]]]]

Contreras (1991) also assumes that, in any case, adjuncts are licensed at S-structure only if they are canonically governed. If not, they are licensed at LF.¹⁷³

¹⁷² This is one of the main differences between Contreras' (1991, 1994) and Olarrea's (1996) analyses.

¹⁷³ In this way, he correctly predicts several contrasts between languages like English, whose I is [-lexical], and Spanish, whose I is [+lexical]. In English topicalization is possible, while it is impossible in Spanish; Spanish shows postverbal subjects while English lacks them; English does

Olarrea's (1996) analysis differs in certain points from that of Contreras (1991, 1994). Olarrea assumes, along with Kayne (1994) and Chomsky (1995), that VP-internal subjects are universally generated as left specifiers of the verbal projection. The basic order is then SVO. This contrasts with Contreras' (1991) analysis, in which the subject is generated as a Spec whose ordering with respect to VP is free, depending on whether, once V moves to I, the subject remains inside the VP (VS) or adjoins to IP (SV).

Nevertheless, some common ground can be found between the two for the basic theoretical framework on V-to-I raising and on negation. Olarrea (1996) also agrees with Emonds (1976), Pollock (1989) and Chomsky (1991), among others, in that languages like English and Spanish differ with respect to V-to-I raising. Standard Spanish has an obligatory rule of overt verb raising that characterizes null-subject languages, while English only raises auxiliary verbs.¹⁷⁴

2.3.2.1. A Unified Account of Preverbal Items and their Positions: Subjects and Objects

The treatment that is given to subjects and objects in a standard analysis has always been non-unified (Ordóñez 1997 and Ordóñez and Treviño 1999). Consider the examples in (85):

not allow null empty subjects, and both languages show “contrasting ranges of closed domain facts” that receive a satisfactory explanation under the close domain condition, i.e., the contrast between (i) and (ii):

- | | | |
|------|---------------------------|-------------------------------|
| (i) | *¿qué lección María sabe? | [what lesson does Mary know?] |
| (ii) | la lección que María sabe | [the lesson that Mary knows] |

¹⁷⁴ As for negation, Olarrea (1996) also defends different ordering in the placement of NegP in English and in Spanish, as well as the fact that preverbal subjects in Spanish do not occupy [Spec AgrSP]. He also adds another argument supporting this fact, with the analysis of interrogative sentences and the approach defended by Arnaiz (1992), Bok-Bennema (1992), Goodall (1991, 1993), Ordóñez (1997), Suñer (1994) and Toribio (1993), among others, that there is no overt I-to-C movement in Spanish. The placement of adverbs is another extra argument used by Olarrea (1996) to back up this idea. (Based on previous work by Bok-Bennema (1992) and Zubizarreta (1994))

- (85) a. **Juan** le dio las llaves a Pedro
 [Juan him give the keys to Pedro]
- b. **las llaves** se las dio a Pedro
 [the keys him them give to Pedro]
- c. **a Pedro** le dio las llaves
 [to Pedro him give the keys]

It has been assumed that in Romance preverbal subjects such as those in (85a) occupy a functional projection, that of [Spec IP], in which Case and agreement are satisfied (Rizzi 1990, Motapanyane 1988, Cardinaletti 1996, Belletti 1990). On the other hand, preverbal objects such as those in (85b) and (85c) are taken to occupy a more external position corresponding to that of a topic.

Thus, sentences with preverbal subjects received the analysis in (86) in which subjects are in [Spec IP], while preverbal O_d s and O_i s received a different analysis as in (87):¹⁷⁵

- (86) [IP [SpecIP Juan] le dio las llaves] SVO
 [Juan him give-3rdps-past the keys]
 [Juan gave him the keys]
- (87) a. [[Topic XP O_d/O_i] [IP *pro* V]] O *pro* V
 las llaves / a Pedro [*pro* le dio]
 [the keys / to Peter [*pro* him give-3rdps-past]]

¹⁷⁵ Given an articulated theory of inflectional projections as in Pollock (1989), this projection would be denominated AgrS. See Belletti (1990). We will continue using the term IP except when the denomination AgrS becomes relevant.

b. [[_{Topic} XP O_d/O_i] [IP [DP subject] V]] OSV

las llaves / a Pedro [Juan le dio]

[the keys / to Peter [John him give-3rdps-past]]

In the case of objects, the IP projection is always present too, either occupied by *pro*, as indicated in (87a), or by a lexical DP subject, as indicated in (87b).

The standard analysis, therefore, leads to a dual characterization depending on which type of preverbal items we are dealing with, that is, whether preverbal subjects or preverbal objects are involved.

Ordóñez (1997) proposes a uniform analysis for all preverbal arguments, independently of their nature, on account of two facts:

- 1) the assumption that there is a null *pro* in IP with a preverbal O_d or O_i conflicts with some facts of ellipsis and extraction of quantificational elements. The conclusion that *pro* cannot be postulated in the preverbal subject position leads naturally, in turn, to the elimination of the idea that there is a preverbal projection that is exclusive for subjects altogether;
- 2) overt preverbal subjects share certain important similarities with preverbal O_ds and O_is regarding constraints on quantificational interpretation.

Ordóñez (1997) proposes the elimination of [Spec IP] as a projection that is exclusive for subjects, something that Contreras had already defended with the elimination of [Spec IP] for subjects in Spanish. Instead, Olarrea analyzes O_ds, O_is and subjects as occupying the same topic position as in (88):

(88) [[_{TopP} XP (subject/O_d/O_i) Top] V ...]

Therefore, the new topic phrase will be the one in which we are to locate the three arguments in (85) above.

A quick look at some cases of ellipsis will illustrate Ordóñez's (1997) approach. Spanish exhibits ellipsis phenomena that differ in several ways from English VP ellipsis. Bruccart (1987) shows that certain discourse polarity particles such as sí ([yes]), no ([not]), también ([too]), and tampoco ([neither]) license ellipsis. The elements that can stand as remnants of this kind of ellipsis include not only preverbal subjects but also preverbal direct and indirect objects, as can be seen in (89):¹⁷⁶

- (89) a. él le dio unos libros a Pía y **Pepe** también [le dio unos libros a Pía]
 [he her gave some books to Pía and Pepe too [her gave some books to Pía]]
- b. unos libros le dio Juan a Pía y **unos cuadros** también [le dio Juan a Pía]
 [some books her gave John to Pía and some pictures too [her gave John to Pía]]
- c. a Pía le dio Juan unos libros y **a Sara** también [le dio Juan unos libros]
 [to Pía her gave John some books and to Sara too [her gave John some books]]

In the three examples, the elided material is enclosed in square brackets and the remnants are indicated in bold type. In (89a), it is the subject NP/DP Pepe that is the remnant, while in (89b) and (89c) unos cuadros and a Sara are both objects, O_d/NP and O_i/PP respectively.

Furthermore, all the remnants of this type of ellipsis can be easily subordinated, as in (90):

¹⁷⁶ The term remnant is taken from Reinhart (1991) and it makes reference to the element that appears on the other side of the conjunction.

- (90) a. Juan le dio unos libros a Pía y me parece que **Pepe** también [le dio unos libros a Pía]
 [John her gave some books to Pía and me think-3rdps that Peter too [her gave some books to Pía]]
- b. a Pía le dio Juan unos libros y me parece que **a Sara** también [le dio Juan unos libros]
 [to Pía her gave John some books and me think-3rdps that to Sara too [her gave John some books]]

Both in (90a) and (90b), the remnants Pepe and a Sara are within the subordinated structure introduced by me parece que.

Under the dual hypothesis in which preverbal subjects occupy a more external position than preverbal O_ds and O_is, Ordóñez (1997) predicts that it would not be easy to capture the parallelism shown by all remnants in the former examples. As reflected in (91), two different types of remnants must be postulated:

- (91) a. [S no/también/tampoco/sí]
- b. [O_d/O_i [*pro* no/también/tampoco/sí]]

Thus, there would be one constituent remnant with preverbal subjects, that is, the subject itself, as in (91a), and two constituent remnants for preverbal objects and *pro*, as in (91b). If this were true, in cases like (91b) and (92a), we may consider it possible to substitute *pro* in IP for an overt subject. Nevertheless, the following example (92b) shows that this prediction is incorrect:

- (92) a. a ti los policías te van a detener, pero me parece que a María el detective
 no la va a detener
 [to you the policemen you go-3rdps to arrest, but me think-3rdps that
 to Mary the detective not her go-3rdps to arrest]

- b. ?? a ti los policías te van a detener, pero me parece que **a María el detective**
no [la va a detener]

Under this analysis, remnants containing a preverbal O_i do not admit a preverbal overt subject without rendering the sentence at least partially incorrect.

Ordóñez's (1997) main proposal in this respect is, therefore, the elimination of the idea that there is a preverbal projection exclusive for subjects and the postulation of a common focus phrase (FocP) for all preverbal arguments.

2.3.3. Preverbal Subjects: Restrictions and Chains

As we have seen, preverbal subjects in Spanish ought to be analyzed in terms of adjunction as CLLD constructions. The preverbal subject in a non-argument position is coindexed with a pronoun in argument position. The relationship that is established between them is considered to be a chain relationship. A chain is then, following Chomsky (1998), a set of occurrences of an item in a constructed syntactic structure.

Cinque (1990) defines a chain as a discontinuous syntactic representation of an argument that is formed not only by movement but also by a mechanism that relates two base-generated positions. The chain condition is defined by Baker (1996) as follows:

- (93) X and Y constitute a chain only if:
- (i) X c-commands Y
 - (ii) X and Y are coindexed
 - (iii) there is no barrier countering Y but not X
 - (iv) X and Y are non distinct in morphosyntactic features

Following Cinque's connectivity, for a predication chain to be licensed, the dislocated phrase and the resumptive pronoun must share certain features or properties. The first feature that the elements in this type of chain must share is their referentiality. Since empty pronominals are referential, the dislocated phrase must also be referential. Olarrea (1996) argues along the lines established by Cinque (1990) and Chomsky (1995) that the functional category D is the locus of specificity, and that there is a strict correlation between specificity and referentiality. This implies that bare NPs are never licensed as preverbal subjects in Spanish, since bare NPs lack a referential index, as defended by Suñer (1982):¹⁷⁷

- (94) a. llegaron alumnos [arrive-3rdpp students]
 b. *alumnos llegaron [students arrive-3rdpp]

As the examples in (94) reveal, while a bare NP as postverbal subject is grammatically correct, a bare NP as preverbal subject renders the sentence ungrammatical.

This very same property accounts for the impossibility of having a non-referential quantifier in a CLLD construction, as in examples (95):

- (95) a. a alguien vi / *a alguien lo vi
 [to someone see-1stps-past] [to somebody him see-1stps-past]
 [I saw someone]

¹⁷⁷ See Contreras (1994) for an analysis of the distribution of bare NPs in postverbal position in Spanish. Olarrea (1996) points out that only conjoined bare NPs can, under certain conditions, appear as preverbal subjects:

- (i) jóvenes y viejos bailaron en la fiesta [young and old dance-3rdpp at the party]

b. algo haré	/	*algo lo haré
[something do-1 st ps-past]		[something it do-1 st ps-past]
c. a nadie vi	/	*a nadie lo vi
[to nobody see-1 st ps-past]		[to nobody him see-1 st ps-past]
d. nada haré	/	*nada lo haré
[nothing do-1 st ps-past]		[nothing it do-1 st ps-past]

The presence of the clitic is what renders these constructions ungrammatical. Thus, while left dislocation is possible and the non-referential quantifier functioning as an object can occupy preverbal position, no resumptive pronoun can be used. On the contrary, referential quantifiers can co-occur with a clitic if they do receive a referential (specific-partitive) interpretation, as in (96):

- (96) a. a todos los estudiantes los vi en la asamblea
 [to all the students them see-1stps-past at the meeting]
- b. a ninguno de ellos lo perdonarán
 [to none of them him forgive-3rdpp-future]
 [they will forgive none of them]

The same restrictions in the specific/non-specific nature of left-dislocated constituents apply in the case of subjects. Thus, a non-specific quantifier subject cannot be left dislocated, unless it receives a strong interpretation (in the sense of partitive/specific), as illustrated in (97):

Olarrea assumes that the presence of the conjunction imposes a specific reading on the preverbal

- (97) alguien le trajo un regalo a María
[someone her bring-3rd ps-past a present to Mary]

In the previous sentence, the interpretation of the subject is clearly partitive and specific: alguien has a partitive reading in that it semantically implies a certain person, one person in a group of people. This contrasts with examples such as the one in (98):

- (98) le dió un regalo a María alguien
[her give-3rd ps-past a present to Mary someone_{subject}]

The partitive reading is not necessarily the case when the quantifier is postverbal. In postverbal position, alguien can receive a non-specific interpretation (one person or another) and, therefore, a different situation appears.

If a predication chain is to be licensed, apart from the specificity/referentiality restrictions, other factors have to be taken into account. We have seen that in order to license the dislocated element in CLLD constructions, that is, in order for it to be interpreted in Spanish, it has to share the inherent referential properties of the resumptive pronoun. But we cannot forget that it has to share not only those, but also Case and Number features.¹⁷⁸

2.3.3.1. Lack of Agreement: The Matching of Person Features

In Spanish, the dislocated element in a CLLD construction must match not only the definiteness and Case features of the resumptive pronoun, but also its

NP.

Number features. Essentially, Person features need not be matched.¹⁷⁹ This accounts for the cases of Person agreement exemplified in (99a):

- (99) a. las mujeres denunci**amos** las injusticias
 | |
 3rdpp 1stpp
- b. las mujeres denunci**an** las injusticias
 | |
 3rdpp 3rdpp

The expected agreement between subject and verb will be the one in (99b). Nevertheless, cases such as the one in (99a) are grammatically correct, too, even if a case of subject-verb disagreement or Person agreement loss may appear.¹⁸⁰ Again the generic reference of the subject plays a very important role here.

According to Hurtado (1985) and Fernández Soriano (1989), constructions with subject NPs may trigger agreement in the first, second or third Person when they refer to a group that may include the first or the second Person:

- (100) los estudiantes de lingüística **tenemos** que ser pacientes
 tenéis
 tienen
- [the students of linguistics have-1stpp that be patient-plural]
 have-2ndpp
 have-3rdpp
- [the students of linguistics have to be patient]

Under the left dislocation analysis we could claim that the preverbal subject los estudiantes de lingüística is adjoined to the highest inflectional projection and

¹⁷⁸ See the issue of agreement in section 2.1.2.

¹⁷⁹ Hurtado (1985) and Fernández Soriano (1989) already accounted for this fact. Example (99a) is taken from Hurtado (1985).

¹⁸⁰ Hernanz and Brucart (1987) have also dealt with this issue.

coindexed with an empty resumptive pronoun in argument position. This empty *pro* dictates agreement with the verb. Evidence from the existence of an empty pronominal that agrees with the verb comes from cases in which an anaphor is present. In these cases, the anaphoric element has to agree in Person Number and Gender with the features of *pro* and not with those of the left-dislocated constituent:

- (101) los estudiantes tenemos un alto concepto de nosotros mismos
 tenéis vosotros mismos
 tienen sí mismos
 [the students have-1stpp a high opinion of ourselves]
 have-2ndpp yourselves
 have-3rdpp themselves

Similar evidence can be found in control structures where the null-subject pronoun, rather than the preverbal NP, is the controller:

- (102) los estudiantes queremos [PRO suicidarnos]
 queréis [PRO suicidaros]
 quieren [PRO suicidarse]
 [the students want-1stpp [PRO to-commit-suicide-ourselves]]
 want-2ndpp [PRO to-commit-suicide-yourselves]
 want-3rdpp [PRO to-commit-suicide-themselves]
 [the students want [to commit suicide]]

The lack of Person agreement in the previous examples cannot be found when the preverbal subject is singular:

- (103) el estudiante de lingüística *tengo que ser paciente
 *tienes
 tiene
 [the student of linguistics have-1stps that be patient]
 have-2ndps that be patient
 have-3rdps that be patient
 [the student of linguistics has to be patient]

Because this ungrammaticality occurs only with subjects that may receive a collective interpretation, Olarrea (1996) assumes that this is due to discourse factors and that the predication relation between left-dislocated subject and the pronominal is restricted to matching of Gender and Case features.

Nevertheless, languages that allow CLLD constructions will not necessarily present cases of Person agreement loss. This is the case of Italian, in which the dislocated element must match the features of the resumptive pronoun in Case, definiteness, Person and Number. In Italian, an example that corresponds to the one in (99a) is ungrammatical:

- (104) *le donne denunziamo le ingiustizie
[the women denounce-1stpp the injustice]

2.3.4. Left-dislocated Subjects and the Null-subject Parameter

Alexiadou and Anagnostopoulou (1996), among others, also claim that in null-subject languages preverbal subjects are CLLD constructions and they use examples from Greek to illustrate this point. In fact, there are common characteristics between Greek and Spanish (Olarrea 1996): both allow for multiple dislocation; in both languages, preverbal subjects have a strong (partitive/specific) interpretation, while postverbal subjects receive a weak, existential interpretation; and a CLLD constituent, as a preverbal subject, is ruled out in interrogative sentences in both languages.

Aside from the previous familiar arguments in favor of the CLLD nature of subjects, Alexiadou and Anagnostopoulou (1996) also claim that relative clauses cannot undergo extraposition in null-subject languages, as the examples in (105a)

and (105b) show for Spanish and Greek respectively; while they can in English, as in (105c) (as observed by Cinque 1983, Barbosa 1997, among others):

- (105) a. *un hombre **vino** que quería hablar contigo¹⁸¹
un hombre que quería hablar contigo **vino**
- b. ?*o anthropos **irthe** ithele na sou milisee
o anthropos bou ithele na sou milisee **irthe**
- c. a man **came** that wanted to talk to you
a man that wanted to talk to you **came**

Nevertheless, as in (106), extraposition in English is blocked when the head of the relative clause is a definite NP):

- (106) *the man came that wanted to talk to you¹⁸²

These authors then show that there is empirical evidence which supports an analysis of preverbal subjects in null-subject languages as CLLD constructions. They also propose that agreement morphology in null-subject languages includes a nominal element according to classical tradition in the PP literature. They offer a standard minimalist account of the properties of null-subject languages as follows. In these languages, V-to-AgrS raising is forced by the presence of a [+strong] nominal feature in this inflectional head that forces overt raising of a syntactic element with a nominal feature in order for the derivation to converge, as in (107):

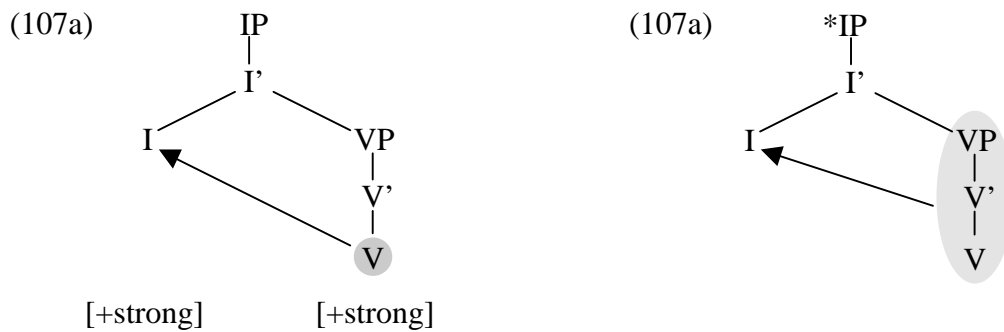

Since V presents this feature, head movement in (107a) and not phrasal movement in (107b) can satisfy the EPP, i.e. can break the [+strong] nominal feature of the highest inflectional head. Obligatory V-to-I raising in null-subject languages is, therefore, explained and the pronominal properties of I in these languages is accounted for. Moreover, it is argued that head movement should be considered less costly for the computational system since it does not expand the phrase marker, that is, since it does not create new structure, and is, in this sense, similar to covert movement.

2.3.4.1. Preverbal Subjects and Interrogative Sentences: *Pro* and Lexical NPs

If we assume that Spanish preverbal subjects are CLLD constructions, the question that arises is why preverbal subjects are not allowed in Spanish interrogatives unless the *wh*-phrase is generated in [Spec CP]. Olarrea (1996) speculates that IP-adjuncts (i.e. preverbal subjects) block covert I-to-C movement. As a result, preverbal subjects are not allowed in Spanish when there is a fronted *wh*-phrase in [Spec CP]:

¹⁸¹ Notice that the structure in (105a) could be accepted if we place a pause after *vino* (Liceras,

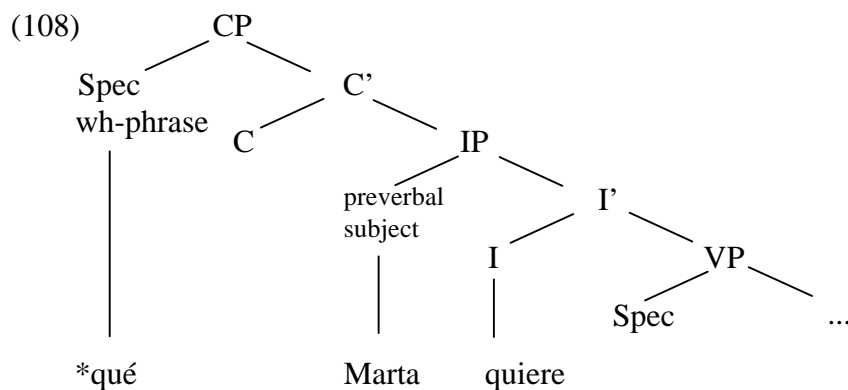

A representation such as the one in (108) would be ungrammatical, therefore, since the preverbal subject (Marta) is blocking I-to-C movement. I cannot raise covertly to C and the required configuration for the satisfaction of the wh-criterion is not met. The derivation will crash at LF due to the presence of a preverbal adjunct, independently of the argumental/non-argumental status of the wh-phrase.¹⁸³

Interrogative sentences oppose relative ones in this respect. The presence of left-dislocated constituents (preverbal subjects, for instance) is grammatical in the case of relative clauses, since they do not present I-to-C movement.

This proposal also predicts that the wh-elements which are base-generated need not be licensed by covert I-to-C and therefore will allow the presence of preverbal subjects in affirmative sentences. At the same time, the analysis of preverbal subjects as base-generated adjuncts to the maximal inflectional projection coindexed with an empty pronominal in argument position correctly predicts the different distribution of preverbal subjects and empty pronominal subjects in Spanish in interrogative sentences. Consider the examples in (109):

personal communication).

¹⁸² Example taken from Olarrea (1996, 128).

¹⁸³ Suñer's (1994) and Olarrea's (1996) analyses contrast in slightly different ways with that of Torrego (1984). For Torrego, VSO order in Spanish is derived from a basic SVO order by a rule of V-fronting, so that the verb moves to a position higher than IP.

(109) a. ¿qué *pro* quieres?

[what *pro* want-2ndps]

[what do you want?]

b. *¿qué Juan quiere?

[what Juan want-3rdps]

[what does Juan want?]

While an empty subject in an interrogative sentence is allowed, as (109a) shows, the presence of a preverbal subject (Juan) in (109b) renders the sentence ungrammatical, as has been previously said.

If we analyze both the preverbal subject and *pro* as occupying the same position, i.e., the canonical position [Spec AgrSP], an accurate account for the contrast present in the previous examples (109a) and (109b) would still need to be given. The contrast is directly derived from the fact that empty subjects are in [Spec VP] prior to Spell-Out and by the fact that preverbal subjects and empty pronominals never occupy the same position in Spanish. The tree diagram in (110) captures the position of preverbal subjects and empty subjects that we have been discussing:¹⁸⁴

¹⁸⁴ As Olarrea (1996) points out, this is true only of what is referred to as standard Spanish, as opposed to Caribbean Spanish. In the latter, the presence of a pronominal element that precedes the verb in an interrogative is perfectly grammatical, as the example in (i) shows:

(i) ¿qué tú quieres?

This type of structure may not be exclusive only of interrogative sentences in this variety of Spanish, but may appear in others such as exclamations, for instance. For further information, see Toribio (1993) and references therein.

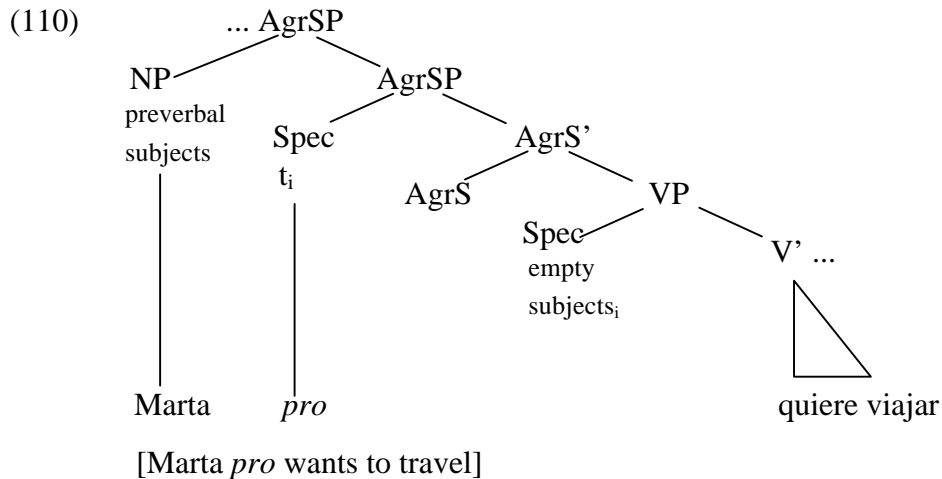

Preverbal subjects and empty subjects never occupy the same position in Spanish and this is how the contrast in the previous examples (109a) and (109b) is explained: empty subjects rather than preverbal ones are accepted in interrogative clauses.

2.4. Postverbal Subjects

Spanish, unlike English, allows postverbal subjects in declarative sentences, as shown in the following examples in (111) taken from Contreras (1991):¹⁸⁵

(111) sabe la lección María

*knows the lesson Mary

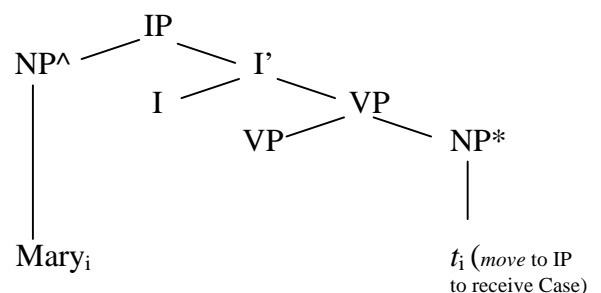
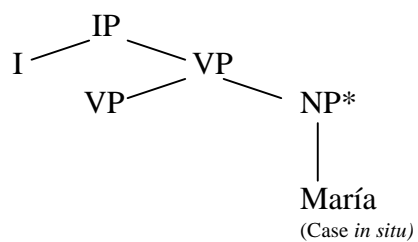

¹⁸⁵ The cases of postverbal subjects in English are very much restricted to certain contexts, especially linked to a poetic use of the language, like in (i), or to certain varieties of English, as the examples in (ii) from a dialect of Belfast English:

- (i) in a distant grave lies his beloved lady (Greenbaum and Quirk 1990)
- (ii) leave you now (Henry 1995)
- arrive you before 6 o'clock (Henry 1995)

In both cases, in Spanish and in English, we are confronted with a VOS order, but while this is acceptable in Spanish, it is not so in English.¹⁸⁶

As has been frequently pointed out, left-dislocation processes may trigger SV inversion, that is, the postponing of the subject. Olarrea (1996) distinguishes three of these processes and groups them into two categories depending on whether a clitic is not present at all or whether it is or may be present. Consider the examples in (112)-(115):

- (112) las rosas, me encantan esas flores (LD + NP)
 [the roses, me love-3rdpp those flowers]
 [roses, I love those flowers]
- (113) Juan, lo vimos a él en la fiesta (LD + clitic)
 [Juan, him see-1stpp-past to him in the party]

 [Juan, we saw him at the party]
- (114) las flores las compré ayer (CLLD)
 [the flowers them buy-1stps-past yesterday]
 [I bought the flowers yesterday]
- (115) ESAS FLORES quiere María (focus construction, emphasis)
 [those flowers want-3rdps María]
 [María wants those flowers]

In the case of (i), the anteposition of the locative in a distant grave is what triggers SV inversion. The cases in (ii), as Henry (1995) claims, are also very restricted to imperatives of unaccusative predicates.

Thus, he opposes left dislocation (LD) and clitic left dislocation (CLLD) to focus constructions.¹⁸⁷ On the one hand, LD may or may not be constructed with a clitic, as in (112) *versus* (113);¹⁸⁸ CLLD, though, requires the obligatory presence of a clitic (or, as we have seen, the corresponding empty category) to license the gap, as reflected in (114). On the other hand, focus constructions do not license a clitic, as exemplified in (115).

In the case of focus constructions, the leftmost phrase constitutes the melodic peak of the sentence, represented here by capitalization, as seen in (115). As the ungrammatical examples in (116) and (117) indicate, there are two characteristics that must be observed: 1) the presence of the dislocated phrase estos anillos must trigger subject-verb inversion (SV inversion), something that does not take place in (116):

(116) *ESTOS ANILLOS María quiere OSV
 [those rings María want-3rdps]

And 2) the dislocated constituent must prevent the licensing of a resumptive pronoun, so that los in (117) is not possible:

(117) *ESTOS ANILLOS los quiere María
 [those rings them want-3rdps María]

¹⁸⁶ See the next section for an approach to the relative position of postverbal subjects with respect to objects (VOS *versus* VSO orders).

¹⁸⁷ What Olarrea (1996) terms focus constructions parallels what Hernanz and Brucart (1987) refer to as rhematization/dislocation (*rematización/dislocación*).

¹⁸⁸ As we have said before, in LD either a clitic or an NP must be present in the sentence and these must be co-referent with the left-dislocated element: las rosas/esas flores in (112) and Juan/lo ... a él in (113).

If both these characteristics are not observed, the result is, therefore, ungrammatical.

A strict correlation then exists between emphasis and the obligatory inversion of SV, unless of course the element in focus is the subject.

In the previous examples, the focused element was always the object of the sentence. But these are not the only elements that trigger SV inversion. Piera (1987), for example, analyzes similar constructions in which an adverb or an adverbial expression occupies the leftmost position and triggers the inversion of the subject:

- (118) TEMPRANO salía Julia de casa
POR LA NOCHE
EN ESTA CIUDAD
CANSADA
[soon leave-3rdps-past Julia of house]
by the night
in this city
tired
[Julia used to leave the house soon / at night / in this city / tired]
- (119) LIMPIA COMO UNA PATENA tenía Julia la casa
[clean as a new pin have-3rdps-past Julia the house]
[Julia's house was always clean as a new pin]
- (120) CANTANDO EN LA DUCHA estaba Julia cuando llegué
[singing in the shower was Julia when arrive-1stps-past]
[Julia was singing in the shower when I arrived]

As the examples in (118)-(120) demonstrate, adverbial phrases and even certain types of adjective phrases and non-finite verbal phrases cause the subject to be placed after the verb (salía Julia, tenía Julia, estaba Julia). Furthermore, as

examples in (121)-(123) reveal, these preposed adverbs are in complementary distribution with a preposed subject:

(121) *TEMPRANO Julia salía de casa
*POR LA NOCHE
*EN ESTA CIUDAD
*CANSADA

(122) *LIMPIA COMO UNA PATENA Julia tenía la casa

(123) *CANTANDO EN LA DUCHA Julia estaba cuando llegué

So that, if the inversion of the subject and the verb is not carried out, the resulting sentences are not grammatical.

Hernanz and Brucart (1987) argue that apart from emphasis there are other factors that contribute to sentences having postverbal subjects. An example would be the presence of certain adverbials in initial position, the lexical nature of the verb and also the length of the NP subject. With regards to the last one, and in normal circumstances, the postposition of the subject is preferred when the NP subject is longer than usual. This sensitivity to the heaviness of the subject is seen in the examples in (124):

(124) a. María ha llamado

[María has phoned]

b. ha llamado María

[has phoned María_{subject}]

c. ?la propietaria del coche robado ayer en pleno centro de Barcelona ha llamado

[the owner of the car stolen yesterday in downtown Barcelona has phoned]

- d. ha llamado la propietaria del coche robado ayer en pleno centro de Barcelona
 [has phoned the owner of the car stolen yesterday in downtown Barcelona]

The examples in (125) show postverbal subjects and their relative order with direct objects:

- | | | |
|----------|--|-----|
| (125) a. | ¿cuándo compró manzanas el hermano de Luis?
el chico que vino | VOS |
| | [when buy-3 rd ps-past apples the brother of Luis / the boy that came]
[when did Luis' brother / the boy who came buy apples?] | |
| b. ? | ¿cuándo compró el hermano de Luis manzanas? | VSO |
| c. *? | ¿cuándo compró el chico que vino manzanas? | VSO |

As the examples in (125) suggest, sentences start to degrade when the subject is made heavier, especially with relative clauses. In these cases, when the subject is too long, the VOS order as in (125a) is preferred to the VSO order in (125b) and (125c). The postverbal subject is maintained but since it is heavier than the object, the subject is placed at the end of the sentence.

As we have seen, focus constructions oppose LD and CLLD constructions in the triggering of SV inversion and also in the presence of a clitic. Table (II) summarizes some of the main differences between the two constructions:

Table II: focus constructions <i>versus</i> LD and CLLD constructions	
FOCUS CONSTRUCTIONS	LEFT DISLOCATION (LD and CLLD)
obligatory absence of a clitic	possible or obligatory presence of a clitic ¹⁸⁹
inversion of the subject	--
only one constituent is fronted (whether it is the subject or any other constituent)	more than one constituent can be left dislocated
the focus element is interpreted as a quantifier ¹⁹⁰	--
they are the result of syntactic movement to [Spec FocP]	they are base-generated adjuncts
they do not obey either strong or weak islands	they obey islands, at least weak ones

2.4.1. Perspectives on VS Order as a Product of Different Processes

Since the earliest analyses of subject inversion in Romance, it has been assumed that either subjects are moved to a postverbal position in which they appear adjoined to the right edge of the VP, or verbs are moved to a position that is higher than the one occupied by the subject. This was the view taken by Kayne (1972) in his analysis of stylistic inversion, Kayne and Pollock (1978), and Rizzi (1982). This perspective was subsequently adopted by Suñer (1994) and Torrego (1984) for Spanish.

Also, as table (II) in the previous section indicates, recent proposals within the MP consider the presence of the FocP projection to capture the cases of VS order.

Therefore, there are at least two different approaches to the nature of subject-verb inversion in declarative sentences: 1) movement of the verb and not of

¹⁸⁹ For an analysis that claims that left dislocations are characterized for not being able to license a clitic, thus paralleling focus constructions, see Zubizarreta (1998). According to Olarrea (1996), such an analysis contradicts the data.

¹⁹⁰ For further analysis on this issue, see Hernanz and Brucart (1987) and Cinque (1990).

the subject; and 2) movement of the verb and of the subject. On the one hand, having Emonds' (1978) and Pollock's (1989) proposals as theoretical background about verb movement, and Koopman and Sportiche's (1991) VP-internal subject hypothesis, VSO order is analyzed as derived by head movement of the verb past the position of the subject. For Torrego (1984) VSO order in Spanish is derived from a basic SVO order by a rule of V-fronting. Contreras (1991) also claims that in Spanish overt V-to-I movement causes VS order since the subject may remain in its base-generated position at [Spec VP], as exemplified in (126):

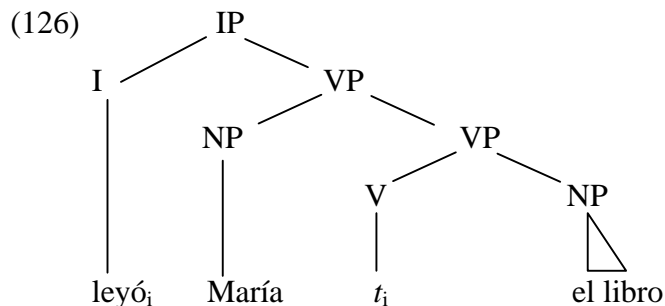

Therefore, we have a double characterization for the subject: if it moves, then SV order appears; if it does not move, the result is a VS order structure.

On the other hand, and within the movement of the subject as the one that explains VS order, there are two more ways of capturing this type of order: right adjunction of the subject and leftward movement of the subject.¹⁹¹ Traditionally, the various analyses of subject inversion have been using the argument of right adjunction in different ways in order to explain that the subject follows the verb.

¹⁹¹ Remember that the right adjunction hypothesis is banned in the MP, more specifically in antisymmetric approaches. According to Kayne (1994), no right-adjunction is generated in syntactic trees.

This is a common phenomenon in a number of Romance languages, as the examples in (127) and (128) indicate in the case of Spanish and Italian:

(127) ayer compró el diccionario un chico

[yesterday buy-3rdps-past the dictionary a boy]

[yesterday a boy bought the dictionary]

(128) ieri ha comprato il dizionario un ragazzo

Suñer (1994) and Torrego (1984), following Rizzi's (1982) analysis of subject inversion in Italian, propose that VS order is obtained by having the subject right-adjoined to the VP as in (129):

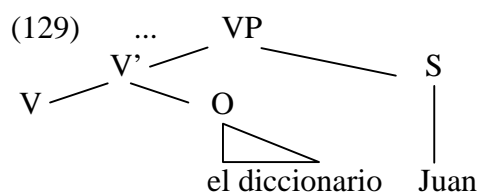

As Ordóñez (1997) manifests, theoretically, there was little reason to question this analysis before two subsequent advances in linguistic theory: the proliferation of inflectional projections (Pollock 1989) and the subject VP internal hypothesis (Kitagawa 1986, Koopman and Sportiche 1991). After all, before the VP internal hypothesis subjects were considered to be base generated in the specifier of IP. Thus, they could only end up post-verbally by movement of the subject to the right, leaving a dummy empty category in the specifier of IP.

Yet, even after these advances made alternatives available, linguists have continued to assume variations of this right adjunction hypothesis. One

representative version is the idea that post-verbal subjects in Romance are in [Spec VP], which branches to the right.¹⁹²

With the MP, the problem with an analysis of VS order in terms of V-movement or in terms of right adjunction is twofold: 1) movement cannot be optional and it has to be motivated; and 2) right adjunction is banned in Kayne's (1994) antisymmetry. Under these premises, the previous explanation by Torrego (1984) and others will not then be possible.

Following minimalist premises and a subject-movement analysis to explain VS order, authors like Olarrea (1996) and Ordóñez (1997) propose two new projections: neutral phrase (NeutP) and focus phrase (FocP). These projections capture the fact that postverbal subjects in Spanish can be neutral (NeutP), apart from being focused (FocP). If the subject is being focused, it moves to a focus position.¹⁹³ Postverbal subjects are not possible in English and generally not possible in French, so SV order is the only one possible.¹⁹⁴ Nevertheless, subjects in these languages can also be focused and thus occupy FocP position.

The obvious difference that exists in the presence *versus* absence of this type of constructions in languages like English and the Romance languages does not make all Romance languages behave in the same way. Even within the wide group of Romance languages, differences arise when dealing with subject-verb inversion. Thus, if we compare Spanish to other Romance languages such as

¹⁹² This proposal has been accepted by Friedemann (1995), among others, for the analysis of French, as in (i):

(i) [VP [V] S]

¹⁹³ In earlier versions, Ordóñez (1994) claimed that VOS order in Spanish is the result of object scrambling. Therefore, the object raises to a position from which it will asymmetrically c-command the subject in [Spec VP]. As with other proposals, we are confronted here with the problem of the optionality and the motivation of movement, as minimalist requirements.

¹⁹⁴ Ordóñez's (1997) analysis holds true mainly for Italian and Catalan. He admits French to be more delicate in the case of postverbal subjects. See Friedemann (1995), Kampers-Manhe (1997) and Ordóñez (1997).

French or Italian, we realize that Spanish allows wider possibilities of distribution for postverbal subjects than these languages.

To explain the contrast between postverbal subjects in Spanish and French or Italian, Ordóñez (1997) defends that French and Italian, contrary to Spanish, lack a neutral phrase position between TP and VP, as in (130):

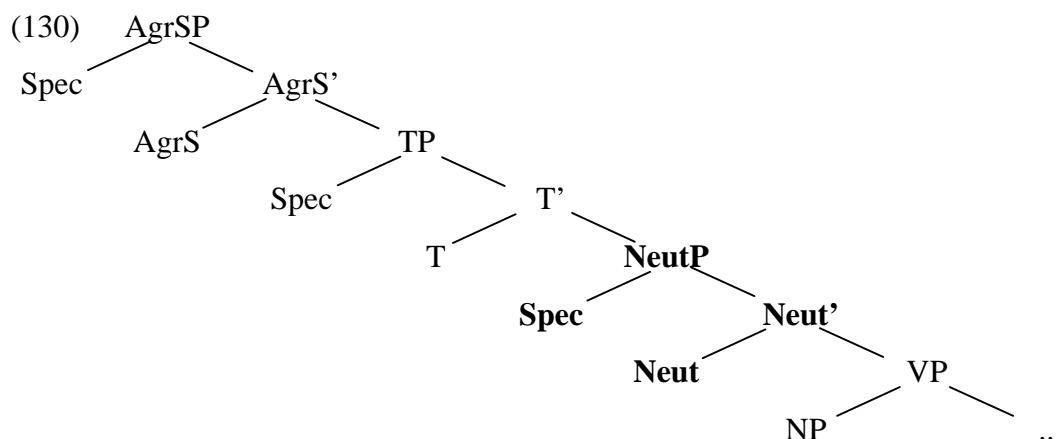

In Spanish, postverbal subjects move to an extra inflectional projection called neutral phrase (NeutP). The verb, in its turn, passes this extra position by head movement, thereby yielding the VSO order.

On the contrary, French and Italian lack this inflectional projection NeutP and thus subjects cannot end up in a post-verbal position by simple head movement of the verb to a higher position past NeutP, as is the case in Spanish.

Focus constructions are the result of movement of the focus element to [Spec FocP]. As argued in Uriagereka (1992) and Ordóñez (1997), the FocP projection corresponds to an intermediate projection between CP and AgrSP, as in (131):

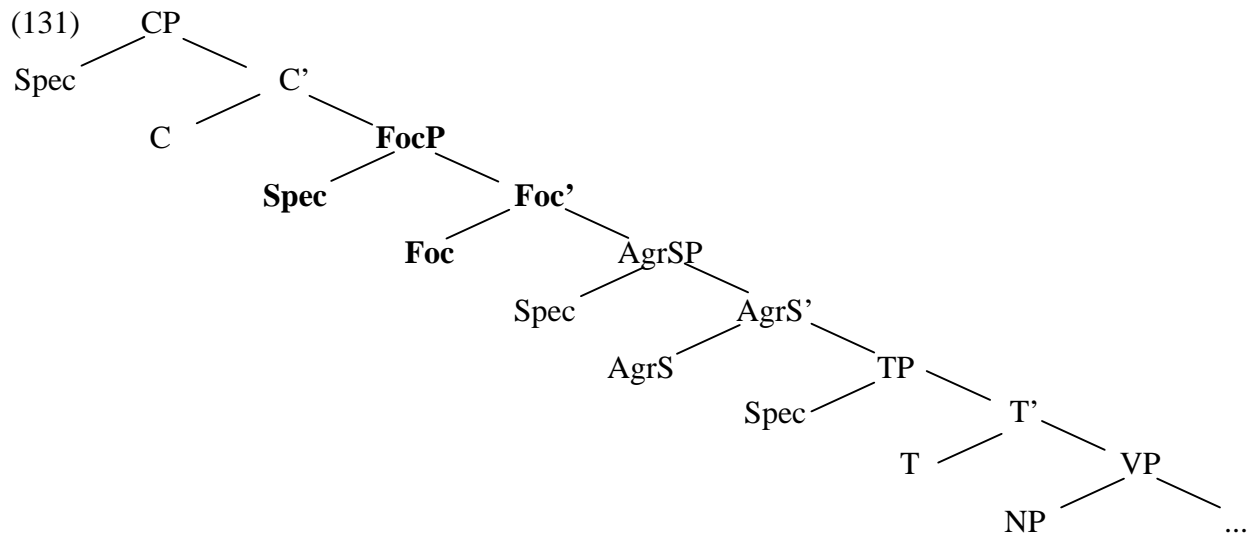

So, when focused, subjects in Spanish, French or English must move overtly to [Spec FocP]. In Spanish, focused subjects end up post-verbally by movement of the subject to a focus position followed by movement of the VP to the left, past this position. VP movement is accounted for in a way parallel to light predicate raising (Larson 1988), or under the VP-shell analysis (Chomsky 1995).¹⁹⁵

This analysis permits us to draw a parallelism between the restrictions on this extra leftward step and other leftward operations within the same language or across languages, thus complying to antisymmetry requirements.¹⁹⁶

2.4.2. A Note on Postverbal Subjects in Declaratives and Interrogatives

As we have seen, Spanish allows subjects to appear postverbally in declarative sentences, which is contrary to English where only preverbal subjects are allowed. In interrogative sentences, the same situation is found, as the examples in (132) and (133) show:

¹⁹⁵ The VP-shell analysis claims that the VP constituent (which includes both the verb and the object) raises to IP, leaving the subject in its base-generated position.

- (132) ¿a dónde va tu hermano? VS where is your brother going? SV
- (133) ¿qué es todo este lío? VS what is all this mess? VS

In interrogative sentences, subjects must occupy a postverbal position in Spanish, while they are still found preverbally with lexical verbs in English; VS order is only attested in interrogative sentences with be (Pollock 1989).¹⁹⁷

According to Ordóñez (1997), there should be a common analysis of this type of inversion in Spanish in declaratives and the inversion resulting from interrogatives, since the two constructions show exactly the same constraints. These constraints affect the restricted positions of subjects which, for instance, are not allowed between the auxiliary and the main verb, as the examples in (134) reveal as opposed to the ungrammaticality of those in (135):

- (134) a. la había visto la madre de Juan
 [her had seen the mother of Juan]
 [Juan's mother had seen her]
- b. ¿a quién había visto la madre de Juan?
 [to whom had seen the mother of Juan]
 [to whom had Juan's mother seen?]
- (135) a. *la había la madre de Juan visto
 b. *¿a quién había la madre de Juan visto?

¹⁹⁶ We should keep in mind that antisymmetry approaches banned right movement or right adjunction.

¹⁹⁷ This section does not constitute a thorough analysis on interrogative constructions. For Spanish, see Torrego (1984), Rizzi (1991), Toribio (1993), Suñer (1994) and Ordóñez (1997). For English, see Kayne (1984), Lasnik and Saito (1984), Chomsky (1986), Pollock (1989), Watanabe (1992b) and Rizzi (1991, 1995).

Another factor that should be taken into account is that there exists a parallelism between wh-phrases (and operators/quantifiers in general) and preverbal focus constituents (Olarrea 1996).¹⁹⁸ This parallelism may also account for the fact that only one constituent can be fronted. The position to which focus constituents move ([Spec FocP]) cannot license the presence of a clitic in the same way that a wh-phrase in [Spec CP] cannot license a direct object clitic in Spanish interrogatives, as (136) reveals:

- (136) a. ¿qué detesta María?
 [what hate-3rdps María]
- b. *¿qué las detesta María?
 [what them-fem hate-3rdps María]
- c. ¿a quién le diste un regalo?¹⁹⁹
 [to whom him give-2ndps-past a present]

The case of focus and interrogative constructions shows that it is clearly unsatisfactory to have two analyses for constructions that are otherwise alike

The presence of these two factors in declarative and interrogative sentences with regards to subjects (their position and the presence of clitics) is what justifies at least mentioning these constructions. Analyses such as the ones by Rizzi (1991), Contreras (1989, 1991), Olarrea (1996) and Ordóñez (1997) will each provide a different perspective on this topic and they will all shed some light on the various aspects involved.

¹⁹⁸ Aside from the subject, all preverbal focus constituents trigger subject-verb inversion.

¹⁹⁹ Clitic doubling of indirect objects is compulsory with pronouns in Spanish while being optional with NP indirect objects. Non-animate direct objects do not require clitic doubling, though.

Rizzi (1991) claims that in interrogative sentences V-movement to the left is obligatory in terms of the wh-criterion, which he formulates as in (137):

(137) wh-criterion:

- a wh-operator must be in a Spec-head configuration with an X [+wh]
- an X [+wh] must be in a Spec-head configuration with a wh-operator

The carrier of the wh-feature is, following Rizzi, the verbal inflection.²⁰⁰ Therefore, I moves overtly to C in order to enter into a Spec-head agreement with the wh-item in [Spec CP], as in (138):²⁰¹

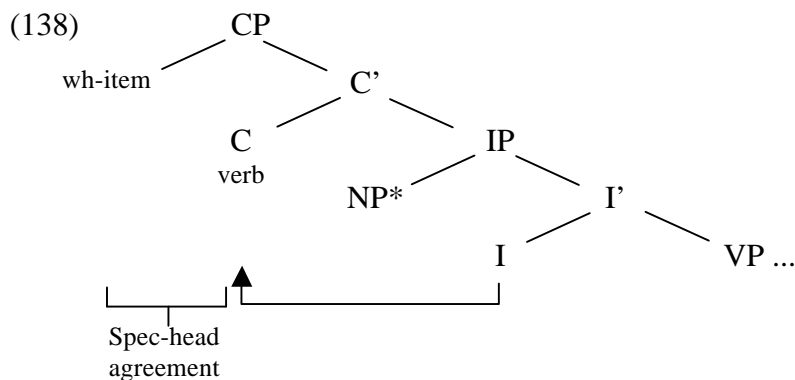

Contreras (1991), as we have seen, suggests two possible analyses for SV/VS order in declarative sentences, assuming that in the case of declarative sentences we are dealing with a declarative default value. This contrasts with interrogatives where no default value appears and only VS order is grammatical. The following tree diagram representation in (139) suggests, in the line of Rizzi (1991), that interrogatives require coindexation between C and I:

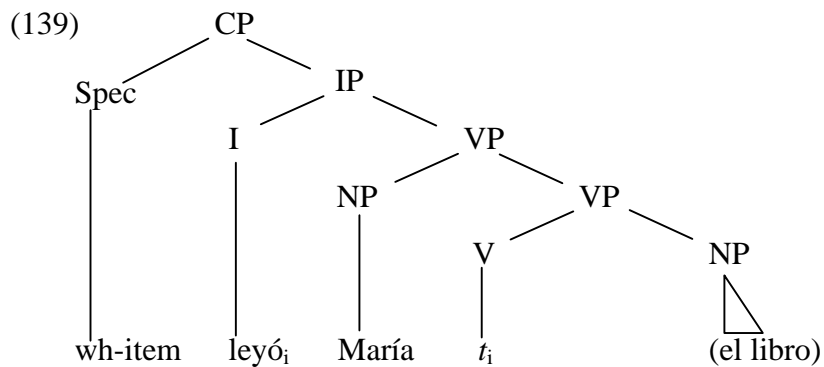

Since there is no sign in Spanish of overt movement from I to C, this coindexation must take place at LF. Suñer (1994) reaches the same conclusion that I-to-C movement in Spanish is not overt.

Olarrea (1996) provides a unified explanation in minimalist terms of VS order both in declaratives and in interrogatives. His proposal is based on the existence of covert I-to-C movement in Spanish interrogatives, in line with Contreras (1991) and Suñer (1994). As the example in (140) shows, subjects move covertly to [Spec IP] in declaratives and in interrogatives; in interrogatives the verb moves covertly as well to C to check [wh] features:

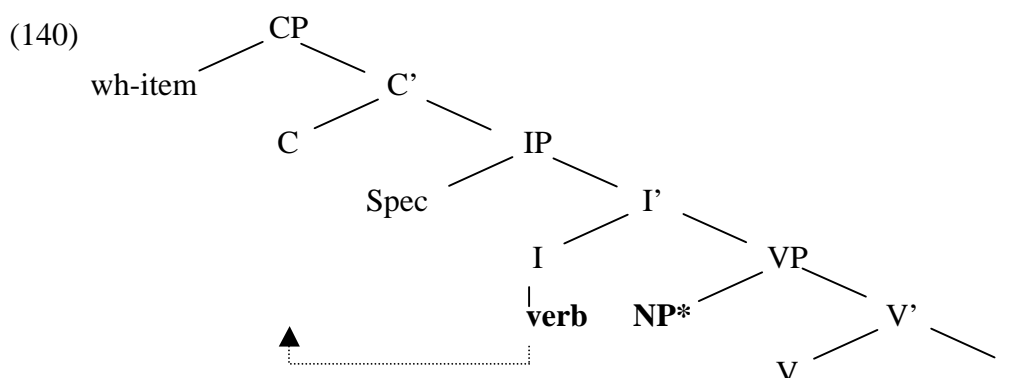

²⁰⁰ In MP approaches, [wh] feature is referred to as the [Q] feature.

²⁰¹ See also Torrego (1984), Goodall (1991, 1993) and Toribio (1993).

At the same time, he claims that left-dislocated constituents, as in (141), block I-to-C movement and that is why preverbal subjects in interrogative constructions are ungrammatical:²⁰²

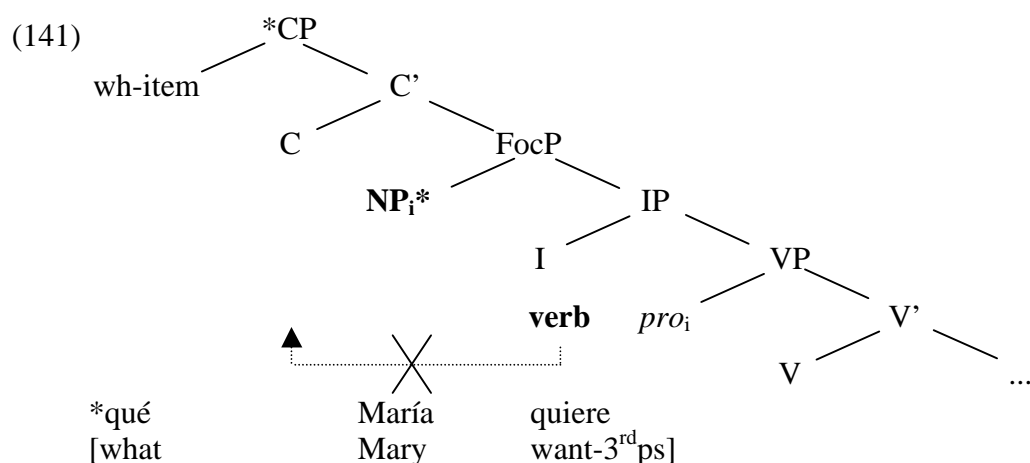

Therefore, SV order is banned in interrogatives while VS order is grammatical in both interrogative and declarative constructions.²⁰³

The same conclusions are reached by Ordóñez (1997), who defends that Spanish lacks overt V-to-C and also has as a point of departure the fact that in Spanish there is an obligatory subject-verb inversion in interrogatives. Nevertheless, in this case the matching of [wh] features is not between the wh-item and verbal inflection, but rather between the wh-item and an empty complementizer in C. The examples in (142) and (143) show the cases of Spanish and English:

²⁰² In the case of relative clauses, the presence of left-dislocated constituents, that is, the presence of preverbal subjects, is grammatical, since I-to-C movement is not present.

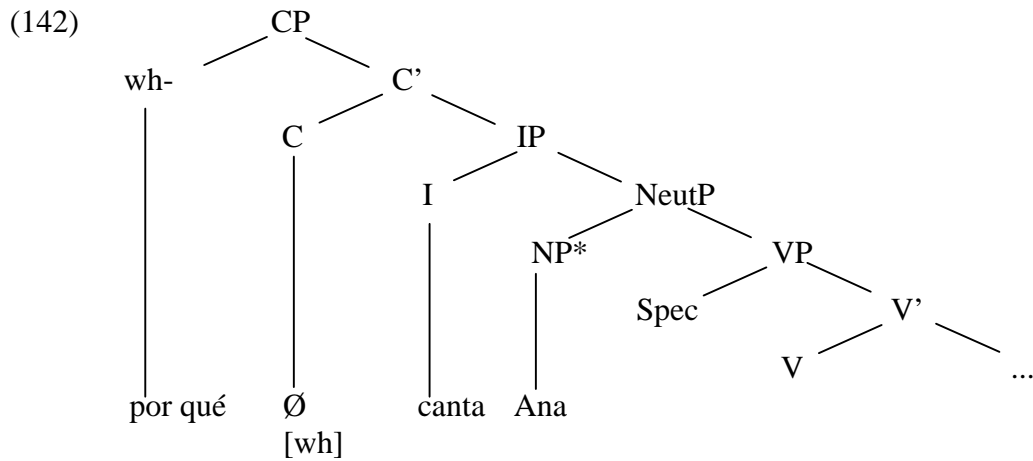

[why Ø-(does) sing-3rdps Ana]

[why does Ana sing?]

As in (142), C in Spanish is \emptyset , the verb raises overtly to IP and the subject, as in a declarative sentence, moves to NeutP. In English, C is lexically filled by do which contains [wh] features, the verb moves covertly to IP to check features, and the subject occupies [Spec IP] position, as in (143):

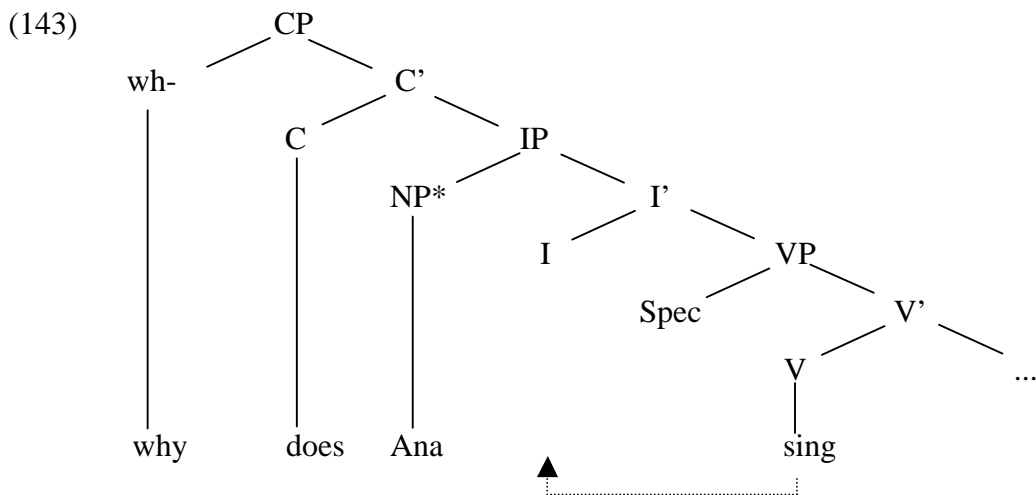

As we mentioned before, postverbal subjects in Spanish and French/Italian do not present the same distribution. Thus, while postverbal subjects in declaratives

²⁰³ Olarrea (1996) also states that wh-elements that are base-generated need not be licensed by

are common in Spanish, they do not usually occur in French.²⁰⁴ In interrogative sentences in French, the VOS order is rather marginal, as reported in Friedemann (1995) with examples such as the one in (144):

- (144) a. *à qui donnera le livre ton ami?
[to whom give-3rdps-future the book your friend]
[to whom will your friend give the book?]
- b. à qui ton ami donnera le livre?
[to whom your friend give-3rdps-future the book]

The most important difference between Spanish and French/Italian is found in the elements that follow the postverbal subject. Nevertheless, it will still be the case that in French and Italian, VS order seems to be quite restricted. Table (III) provides a summary of the elements following the postverbal subjects:²⁰⁵

covert I-to-C movement and, therefore, will allow the presence of preverbal subjects.

²⁰⁴ For inversion in French, see Kayne (1972), Rizzi and Roberts (1989), Korzen (1992) and Ringqvist (1997).

²⁰⁵ For the complete analysis, see Ordóñez (1997). While this author concentrates on Spanish, on the one hand, and Italian, Catalan and French on the other, in table (III) we only deal with Spanish and French. English, as has been previously said, entirely lacks this type of structure.

Table III: elements that follow postverbal subjects		
ORDERS	SPANISH	FRENCH
V S DP (object)	Ok ¿cuándo ha escrito Juan la carta? ¿a quién va a dar a tu amigo la carta?	* *quand a écrit Jean la lettre? *à qui donnera ton ami la lettre? ²⁰⁶
V S PP (complement)	Ok el día en que hablará Juan con María	?? ??quand changera cette fille d'avis? ²⁰⁷
V S PP (locative)	Ok ¿qué hace tu hermano en la vida? [¿a qué se dedica?]	Ok que fait ton frère dans la vie? ²⁰⁸
V S Adj	Ok se hace usted viejo los vio Rita borrachos	* *quand deviendra ce comédien célèbre? ²⁰⁹
V S Adv (de- adjectival)	Ok camina usted lento este año trabaja Paco duro en su tesis	* *quand a risqué cet étudiant gros? ²¹⁰
V S Infinitive	Ok ¿con quién podrá Cecilia ir a J.H.?	* *que pouvait ta mère faire? ²¹¹
V S CP	Ok ¿con quién dice María que saldrá Juan?	? to ok ?avec qui a prétendu Marie que sortirait Jean? ²¹²

The examples in this table reveal that, in fact, Spanish, contrary to French, allows a wider distribution of subjects also in the case of interrogative sentences.

2.4.3. Postverbal Subjects and Focus: VSO / VOS Structures

Pragmatically, the VSO and the VOS orders differ with respect to their interaction with focus.²¹³ Zubizarreta (1995) points out that the VSO order can be

²⁰⁶ The first example is taken from Zubizarreta (1994) and second from Friedemann (1995). [when has written John the letter?] [to whom will give your friend the letter?].

²⁰⁷ The first example is taken from Kayne (1986) [the day when speak-3rdps-future John with Mary] and the second from Kayne (1972) [when will change this girl of opinion?].

²⁰⁸ Example taken from Kayne (1972) [what does your brother in life?].

²⁰⁹ Example taken from Kayne (1972) [you-make you old; you are getting old] [them saw Rita drunk; Rita saw them drunk] [when turn-3rdps-future this comedian famous?].

²¹⁰ [walk you slow; you walk slowly] [this year work Paco hard on his thesis; this year Paco is working hard on his thesis] [how much has risked this student much?].

²¹¹ [with whom can-3rdps-future Cecilia go to J.H.?] [what can-3rdps-past your mother do?].

²¹² Example taken from Kayne and Pollock (1978) [with whom has pretended Mary that go-3rdps-future out John; with whom has Mary pretended that John will go out?].

associated with a number of different focus structures. The specific structure depends on which element receives the main sentence stress. If the object receives the main sentence stress, the assertion could be the object and the subject together as in (145):²¹⁴

(145) ¿a quién le prestó **Juan el diccionario**?

[to whom him lend-3rdps-past Juan the dictionary]

[to whom did Juan lend the dictionary?]

If the subject receives the main sentence stress, the object gets downstressed. In this case the subject will be the only assertion, as in (146):

(146) ¿a quién le prestó **Juan** el diccionario?

[to whom did Juan lend the dictionary?]

To better see the discourse properties of the VSO order, the question-answer test will be used. For a question such as (147) -in which the subject is introduced in the discourse- an answer with a VSO order as in (148a) will be considered inappropriate. Only a response such as (148b), with the SVO order, is possible. It can be concluded that subjects in the VSO order must not be presupposed:

(147) ¿qué compró Juan?

[what did Juan buy?]

²¹³ Focus is all possible material that might be part of the assertion, as opposed to that material which is already presupposed.

²¹⁴ The main sentence stress appears in bold type and the possible assertion is underlined.

(148) answer a: *ayer compró Juan un libro VSO
[yesterday bought Juan a book]

answer b: ayer, Juan compró un libro SVO
[yesterday, Juan bought a book]

On the other hand, the VSO order can be an answer to a “what happened” type question as in (149). This fact is evidence that the subject in the VSO must be included in the assertion:

(149) ¿qué pasó ayer? Ayer ganó Juan **la lotería**²¹⁵
[what happened yesterday? Yesterday won Juan the lottery]

Note that the subject need not receive the main sentence stress, and therefore it need not be understood as the only focus in these VSO orders.²¹⁶

In the VOS order, the subject receives the main sentence stress, and it can be the only understood focus of the sentence, as in (150):

(150) ¿a quién le prestó el diccionario **Juan**?

This can be shown because VOS order can only be an answer to a question about the subject, as in (151). It cannot be the answer to a question like “what happened” as in (152):

²¹⁵ As Ordóñez (1997) points out, in the context of an answer to a question the VSO and the VOS orders seem to require an initial XP before the verb. So the order XP VSO sounds more natural than the VSO order. The VSO order might also be preceded by the conjunction que [that]:

(i) ¿qué pasó? [what happened?]
(ii) answer: *compró Juan un perro [bought Juan a dog]
answer: que compró Juan un perro [that bought Juan a dog]

²¹⁶ For cases with ellipsis, see Ordóñez (1997).

- (151) ¿quién ganó la lotería ayer? ayer ganó la lotería **Juan**
 [who won the lottery yesterday?] [yesterday won the lottery Juan]
- (152) ¿qué pasó ayer? *que ayer ganó la lotería **Juan**
 [what happened yesterday?] [that yesterday won the lottery Juan]

Thus, it can be concluded that in the VOS order in Spanish, contrary to the VSO order, the subject must receive the main sentence stress and be narrowly focused.²¹⁷

There are two prosodic structures that are associated with the VSO order: a more neutral one in which the object receives the main sentence stress and a marked one in which the subject receives the main sentence stress (see also Zubizarreta 1998). It follows that post-verbal subjects in Spanish can end up in the VSO order without the main sentence stress. Thus, subjects can be neutral in Spanish apart from being focused as in the VOS order.²¹⁸

2.4.4. Fully Referential NPs *versus* Pronouns as Postverbal Subjects

An interesting point remains in the case of postverbal subjects. As Ordóñez (1997) discusses, there seems to be a difference between fully referential NPs and pronouns as postverbal subjects. Unlike fully referential NPs, unstressed post-

²¹⁷ It is important to not confuse the VOS order discussed here with a VOS pattern in which the subject is downstressed and there is an intonational break before the subject. In the case of the latter, the answer in (i) becomes appropriate in a context in which Juan is presupposed in the discourse:

(i) ¿qué pasó ayer? que ayer no ganó **la lotería** // Juan
 [what happened yesterday?] [that yesterday not won the lottery // Juan]

²¹⁸ French is more delicate in this respect. The pragmatics of stylistic inversion are complicated given that French is not a null-subject language, and the inversion needs a trigger such as wh-movement or the subjunctive mood. Focus, however, seems to play a crucial role in the subjunctive constructions studied by Kampers-Manhe (1997).

verbal subject pronouns are restricted to the VSO order as can be seen by the contrast in (153) and (154):²¹⁹

(153) a. ¿qué les compró él a sus hermanos? VSO

[what them bought he to his brothers?]

b. *¿qué les compró a sus hermanos él? VOS

[what them bought to his brothers he?]

(154) a. ¿qué le compraron ellos a él? VSO

[what him bought they to him?]

b. *¿qué le compraron a él ellos? VOS

[what him bought to him they?]

The ungrammatical example where the subject pronoun follows the complement contrasts with the example where the post-verbal subject in the VOS order is a full NP. Observe the contrast between (153) and (154) and the examples in (155):

(155) a. ¿qué le compraron a él los estudiantes?

[what him bought to him the students?]

b. ¿qué le compró a él el profesor?

[what him bought to him the professor?]

In order to obtain the VOS order in these cases, the pronouns must be heavily stressed, and an intonational break must appear before the pronoun as in (156a) and

²¹⁹ Pronouns which are morphologically complex like nos-otros ([we]), vos-otros ([you-plural]) do not trigger the effects that are observed by the mono-morphemic ones. Under Cardinaletti and Starke's (1994) approach, these pronouns pattern with what they call strong pronouns, which are not subject to the distributional restriction that the mono-morphemic ones are subject to:

(i) ¿qué les comprasteis a sus hermanos vosotros?
[what cl-bought for his siblings (O_I) you-plural (S)"]

(156b). A subject pronoun might also appear in this order when coordinated with another NP, as in (156c):

(156) a. ¿qué les compró a sus hermanos // ÉL?

[what them bought to his brothers HE?]

b. ¿qué le compraron a él // ELLOS?

[what him bought to him THEY?]

c. ¿qué les compraron a sus hermanos él y su hermana?

[what them bought to their brothers he and his sister?]

The data in (153) and (154) suggest that post-verbal subject pronouns in Spanish must necessarily be scrambled to the left.²²⁰ It has been noted in the literature that the distribution of unstressed pronouns can be different from the distribution of full NPs or stressed pronouns.

2.5. A Comparison of SV / VS Orders: A Summary

Under minimalist terms, Olarrea (1996) accounts for both VS and SV orders in Spanish in a unified way. The verbal features of T and AgrS in Spanish are [+strong] and thus force the overt raising of the verb. The nominal categorial features of AgrS, on the other hand, are [-strong].²²¹ Subjects are generated in

[what did you buy for his siblings?]

²²⁰ The term scrambling makes reference to the movement of an element within a clausal domain.

²²¹ Olarrea (1996) does not deal with the value of the N-related feature of T in Spanish or with the possibility of this functional head projecting a specifier position. He concentrates on the nominal features of AgrS which are [-strong], and on the fact that, in consequence, the VP-internal subject will check its features at LF. Independently of the strength of the features of T, and due to the fact that the subject raises to AgrS covertly, the result is always the postverbal position of the thematic subject in the overt syntax, since V raises to AgrS. Together with Jonas and Bobaljik (1993), he assumes that Spanish does not project a specifier in TP.

[Spec VP] and will raise covertly to the position in which their inflectional features are checked, [Spec AgrSP]. The tree in (157) reflects this process:

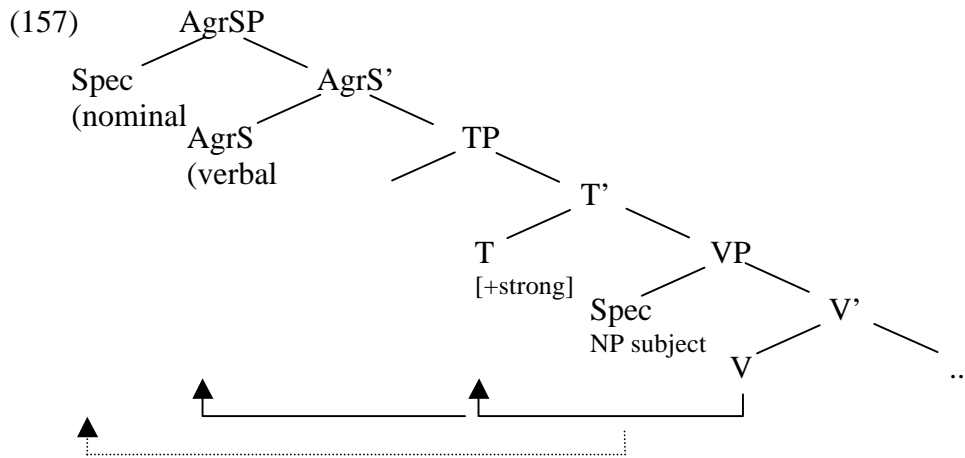

A VS sentence is thus the result of V adjunction to AgrS, via cyclic adjunction to the intermediate functional heads. This movement is the product of the [+strong] verbal categorial features of AgrS. This strong feature attracts the categorial feature of the verbal head. Movement is overt and takes place before any further structure is created by a new application of *merge*.²²² Before Spell-Out, then, the representation of a VS sentence in Spanish is as in (158):

(158) [_{AgrSP} [_{AgrS'} sabe_k [_{TP} t_k' [_{VP} María [_{V'} t_k la lección]]]]]

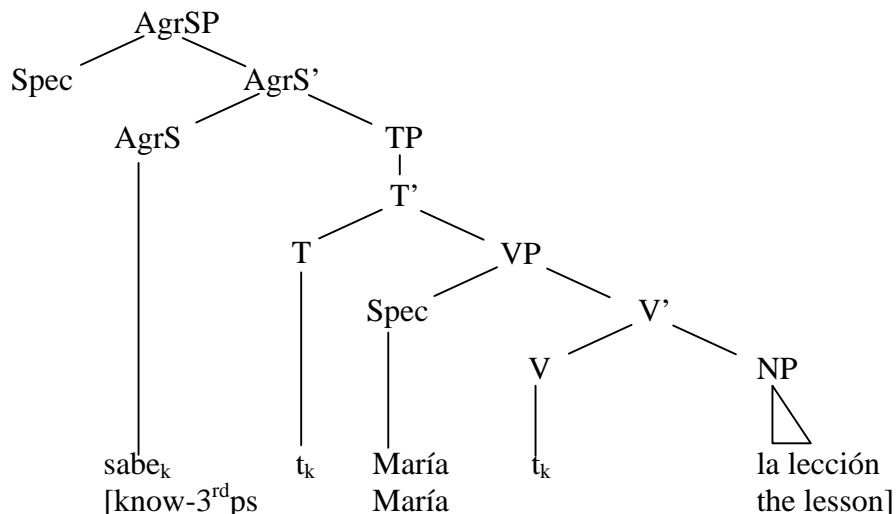

In the overt syntax, the verb will always precede the thematic subject. At LF, the subject -or rather, its formal features FF (S), following Chomsky (1995)- will raise to [Spec AgrSP] attracted by the nominal categorial feature of AgrS, a feature that Olarrea (1996) assumes to be specified as [-strong]. This movement at LF is the result of the principle of procrastinate which rules out overt movement of the subject when there is no [+strong] nominal features that attract it. Movement at LF is more economical than overt movement. The resulting LF configuration is, then, as in (159):

(159) [_{AgrSP} [_{AgrS'} sabe_k [_{TP} t_k' [_{VP} María [_{V'} t_k la lección]]]]]]

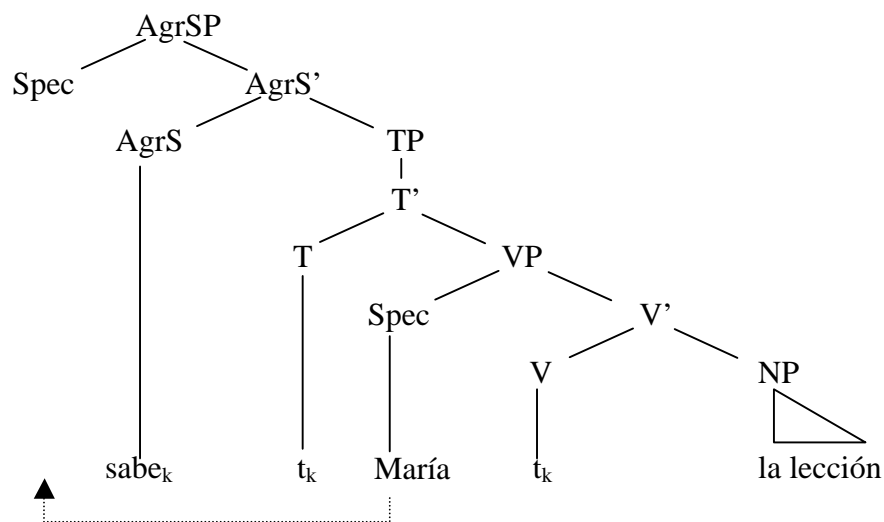

In example (159), both the subject and the verb are in the checking domain of the AgrS head, and the phi-features of both the subject and the verb can be checked. If these features are identical the derivation converges and agreement is obtained.

²²² Recall that the presence of a [+strong] feature cancels the derivation.

In the SV order, the thematic subject is a null referential pronoun *pro* that follows the verb in the overt syntax, as shown in (160).²²³ This null resumptive pronoun is coindexed at LF with a NP base-generated as an AgrSP adjunct. This position is broadly L-related, i.e., a non-argument position. Before Spell-Out, then, an SVO sentence in Spanish presents the following configuration:

(160) [_{AgrSP} María_i [_{AgrSP} [_{AgrS'} sabe_k [_{TP} [_{T'} t_k [_{VP} *pro*_i [_{V'} t_k la lección]]]]]]]]

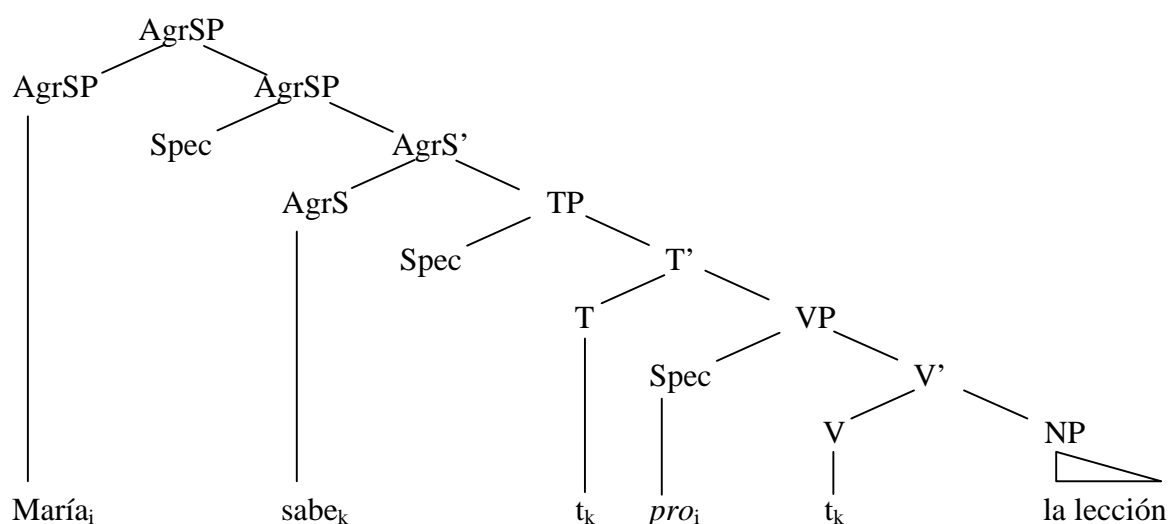

At LF, the thematic null pronominal raises to [Spec AgrSP] to check the [-strong] nominal feature of AgrS. At this level of representation, the left-dislocated subject and the null pronominal are coindexed. The thematic null pronominal and the verb are in the checking domain of AgrS and agreement is between the verb and the pronominal subject, as in (161):

²²³ Remember that, according to Olarrea (1996), preverbal subjects in Spanish are not the result of movement, but are rather left dislocated and coindexed with an argumental empty resumptive

(161) [_{AgrSP} María_i [_{AgrSP} [_{AgrS'} sabe_k [_{TP} [_{T'} t_k [_{VP} pro_i [_{V'} t_k la lección]]]]]]]]]

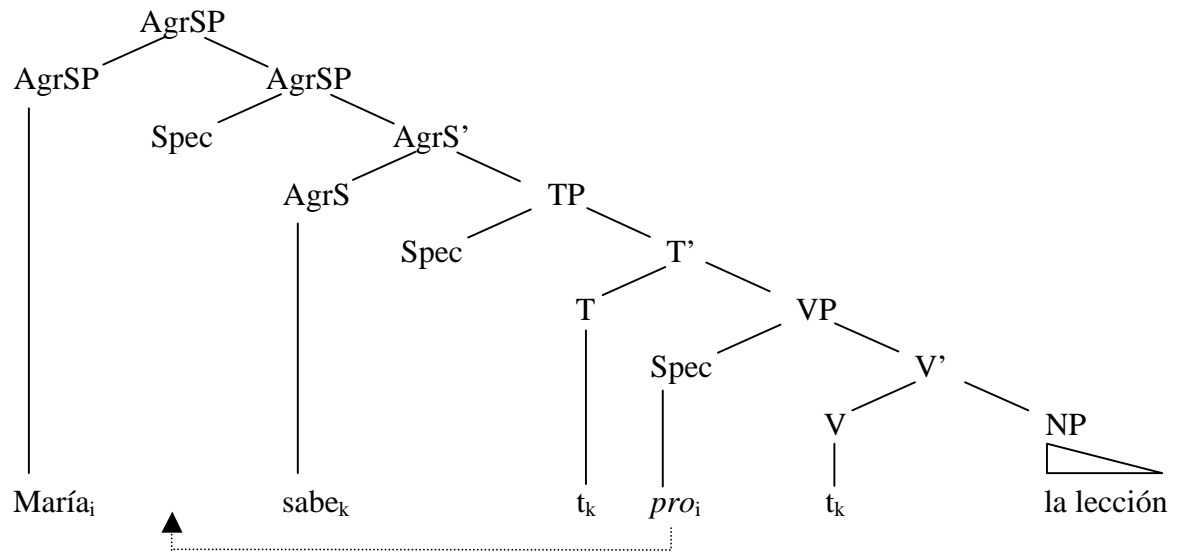

In both the VS and SV orders, the configurations in which agreement and nominative Case are checked are the same Spec-head configurations, as shown in the following abstract sentence structure in (162):

(162) a. before Spell-Out

VS order: [_{AgrSP} [_{AgrS'} V+T [_{TP} [_{T'} t_T [_{VP} NP [_{V'} t_V]]]]]]]]]

SV order: [_{AgrSP} NP_i [_{AgrSP} [_{AgrS'} V+T [_{TP} [_{T'} t_T [_{VP} pro_i [_{V'} t_V]]]]]]]]]

b. after Spell-Out

VS order: [_{AgrSP} [_{AgrS'} V+T [_{TP} [_{T'} t_T [_{VP} NP [_{V'} t_V]]]]]]]]]

SV order: [_{AgrSP} NP_i [_{AgrSP} [_{AgrS'} V+T [_{TP} [_{T'} t_T [_{VP} pro_i [_{V'} t_V]]]]]]]]]

pronoun that dictates the agreement with the verb and checks the nominal categorial feature of AgrS and nominative Case by Spec-head agreement at LF.

Subject agreement is checked in a Spec-head relation between the subject NP or *pro*, and the complex [_{AgrS} V+T]. The preverbal NP in the SV order gets interpreted at LF by coindexation with the thematic *pro*. Both elements, the adjoined NP and the null pronominal, must share their phi-features (this feature-sharing is constrained in certain ways, which accounts for the possibility of loss of Person agreement).

There are differences in the analysis of Case and theta-theory. Olarrea (1996) argues in favor of distinguishing SV and VS orders in Spanish as the derivational result of two different numerations: in the SV order an empty pronominal argument *pro* is present, while it is absent in the VS order. As an alternative to Olarrea's (1996) analysis, Alexiadou and Anagnostopoulou (1996) propose that SV and VS orders in null-subject languages are the derivational result of the same numeration. Since V-to-I movement can satisfy the EPP, the formal features of the subject (FF, S) do not raise covertly in either case, SV or VS constructions. In order to account for that, it also has to be assumed that verbal morphology is [+Case]. According to Alexiadou and Anagnostopoulou (1996), then, the differences between both orders correspond merely to a difference between two possibilities: merging the subject within the verbal projection or merging it as an adjunct to AgrSP, both possibilities being non-distinct with respect to the economic metric. Nevertheless, the two analyses are very similar since they both defend that preverbal subjects are CLLD constructions.

From the previous analysis, subjects in Spanish occupy then a more external position than they do in English. Both English and Spanish subjects are generated in [Spec VP]: English preverbal NPs or pronouns, Spanish preverbal *pro* and Spanish postverbal NPs. Nevertheless, while English subjects raise to [Spec IP]

overtly, Spanish subjects remain in [Spec VP]. At the same time, if we concentrate on Spanish preverbal subjects (adjuncts) and English preverbal ones (arguments), it is Spanish subjects that are placed in a more external position, as adjuncts to IP.

Evidence to support this idea could be drawn from the behavior of complementizerless dependent clauses in both languages, as Ordóñez (1997) points out:

(163) Jane regrets Melissa is not home

(164) *Jane siente Melissa no esté en casa

Jane siente que Melissa no esté en casa

As the examples in (163) and (164) reveal, complementizers can be dropped in English clauses while such an operation would render the sentence ungrammatical in Spanish.²²⁴

With regards to preverbal subjects, these are not allowed in complementizer dependent clauses in Spanish. See (165) as opposed to the previous example in English:²²⁵

(165) *lamento Carmen no esté contenta

[regret-1stps Carmen not is happy]

[I regret Carmen is not happy]

On the contrary, postverbal subjects in the same circumstances are perfectly grammatical:

(166) lamento no esté contenta Carmen

²²⁴ Notice that certain dialects of Spanish also allow this kind of complementizer deletion (see Torrego 1982).

²²⁵ Examples (165) and (166) are taken from Torrego (1982).

[regret-1stps no is happy Carmen]

[I regret Carmen is not happy]

At this point and when comparing English and Spanish, Ordóñez (1997) makes a very interesting observation by establishing a connection between the ungrammaticality of the following sentences in (167) and (168):

(167) *lamento [_{TopP} Carmen_i [_{IP} pro_i no esté contenta]]

(168) *Jane regrets [_{TopP} yesterday [_{IP} Melissa went to her house]]

The ungrammaticality of (167) in Spanish is caused by the presence of a preverbal subject and the absence of the complementizer *que*. In (168) it is the peripheral time adjunct *yesterday* what renders the sentence ungrammatical in English. It follows from these examples that the adjunct *yesterday* in English and the preverbal subject in Spanish would occupy more peripheral positions, which could not be licensed in this type of construction. Thus, the following correspondences between English and Spanish can be established: preverbal subjects in English correspond to *pro* in Spanish just as lexical subjects in Spanish correspond to adjuncts in English.

The tree diagrams in (169) illustrate the case of Spanish preverbal subjects in neutral constructions (adjunct IP) and in focus constructions (FocP):

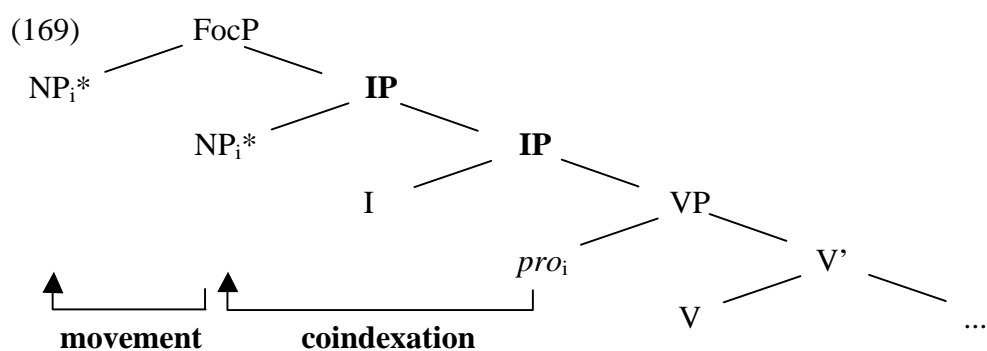

Since Spanish presents overt V-to-I movement, the SV order appears in neutral constructions with the subject NP adjoined to IP and therefore in a higher position than V, and also in marked constructions where the subject NP moves to FocP.

The corresponding representation for English preverbal subjects is shown in (170):

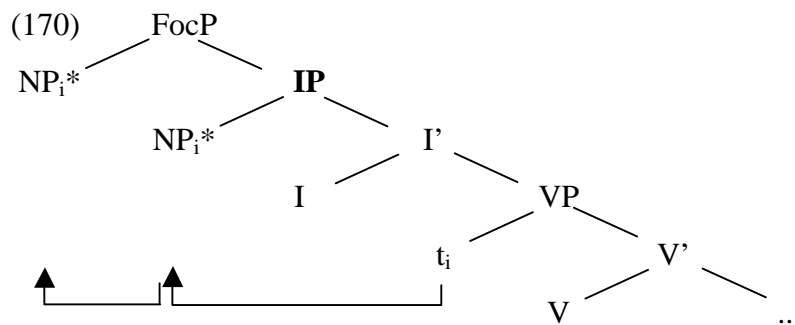

English has covert V-to-I movement so that only verbal features are moved to IP to be checked. The overt movement of the verb to [Spec IP] in neutral constructions and further up to FocP in focus ones renders SV order. This will always be the case in English, since postverbal subjects are not possible.

Postverbal subjects in Spanish in neutral and marked constructions are presented in (171):

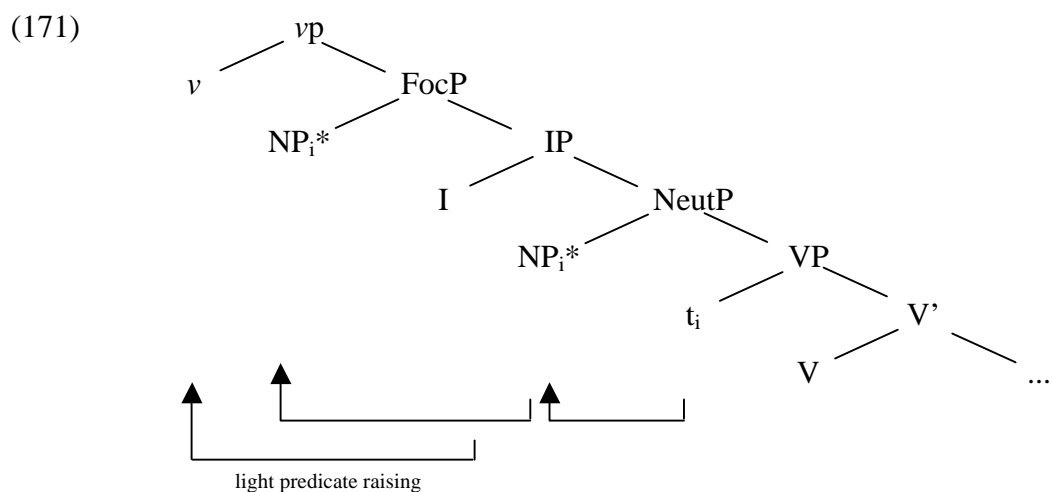

Postverbal subjects located in [Spec VP] move to NeutP, a projection that is between IP and VP. Therefore, when overt V-to-I movement takes place VS order appears. If the subject NP* receives focus, then it raises to FocP; this movement is followed by raising I to a position higher than FocP in the manner of light predicate raising (Larson 1988, Chomsky 1995).

The following table provides a summary of the main differences found between preverbal and postverbal subjects with the information drawn from the previous sections:²²⁶

Table IV: characterization of subjects			
preverbal subjects		postverbal subjects	
Spanish	English	Spanish	English
adjuncts real argument: <i>pro</i>	arguments	arguments	--
process of adjunction	movement	movement	--
position: adjunct to IP <i>pro</i> in [Spec VP]	from [Spec VP] to [Spec IP]	from [Spec VP] to NeutP	--
argument <i>pro</i> never higher than [Spec VP]	argument higher than [Spec VP]	argument higher than [Spec VP]	--

As table (IV) suggests, there is an interesting parallelism between preverbal subjects in English and postverbal subjects in Spanish. The basic assumption is that

²²⁶ Uribe-Etxebarria (1992) analyzes the different implications between preverbal and postverbal subjects in terms of scope ambiguity. Also Bentivoglio and Weber (1986) and Ocampo (1989) deal with the frequency of SV and VS orders in Spanish.

Spanish lacks [Spec IP], as opposed to English. The main characteristics of subjects are the following:

- 1) Spanish preverbal subjects are adjuncts, the real argument being the resumptive *pro*; English preverbal subjects as well as Spanish postverbal subjects are arguments.
- 2) The process involved in the generation of Spanish preverbal subjects is adjunction, while again in the case of both English preverbal subjects and Spanish postverbal subjects there is movement.
- 3) The position occupied by Spanish preverbal subjects is double and there is a relationship of coindexation between the elements in both positions: adjunct to IP for the preverbal subject and [Spec VP] for *pro*. English preverbal subjects and Spanish postverbal subjects move from [Spec VP] to [Spec IP] in the case of English and to NeutP in the case of Spanish.
- 4) From the characteristics mentioned above, it follows that the real argument in Spanish preverbal constructions (*pro*) is never placed higher than [Spec VP], while both in the case of English preverbal subjects and Spanish postverbal subjects, subject arguments are always found in a position higher than [Spec VP].

3. EXPLETIVES

3.1. Introduction: Expletives and Subjects

3.1.1. Outline

The treatment of the position of subjects and word order which was dealt with in the previous chapter has consequences for the analysis of expletive constructions. We will specifically deal with the type of English and Spanish/French expletive constructions exemplified in (1):²²⁷

(1) there is a man in the room

pro hay un hombre en la habitación

il y a un homme dans la chambre

²²⁷ Our study focuses on English and Spanish expletive constructions. French is included when it sheds some light on the analysis, although the analysis of it will not be as thorough. As a Romance language, French is supposed to show the same characteristics as Spanish, thus opposing English. There are also several analyses (Kayne 1981, Pollock 1982, Safir 1982, Travis 1984) that equate French to English expletive constructions as being subject to the same restrictions. Nevertheless, as Belletti (1987) points out, the French *il* construction is much more productive than the English *there* construction.

The main issues that arise with these structures affect the concept of subject. As we have seen, the extended projection principle (EPP) requires that a category occupies [Spec IP/VP]. Following Chomsky (1998), two options are available: either move the subject in [Spec VP] or merge there (as in expletive constructions), as in (2):²²⁸

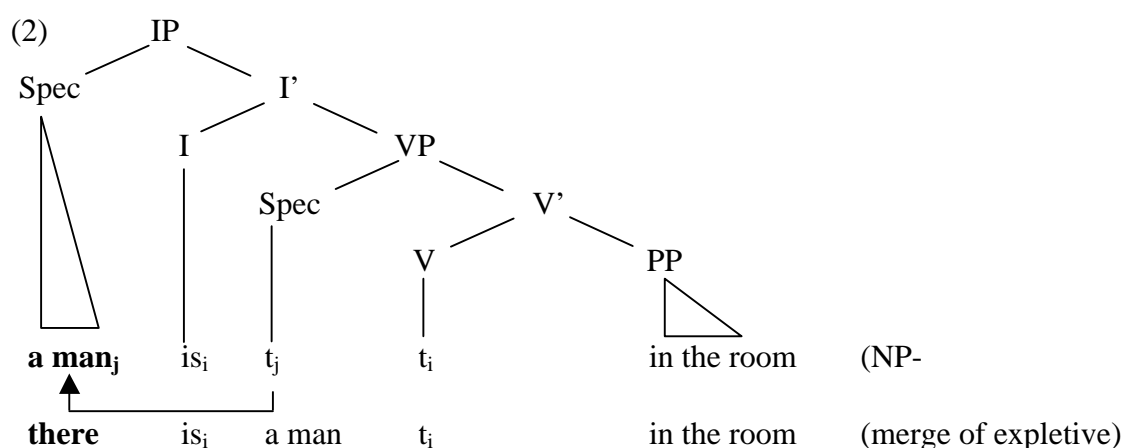

The choice depends on whether or not an expletive is available in the initial lexical array.

These constructions may then be viewed as structures that contain two potential subjects: a preverbal subject (the expletive element that serves as a syntactic place holder, there in English, *pro* in Spanish) and a postverbal subject (the NP that carries the semantic content of the sentence).²²⁹ A special type of relationship is, therefore, established between these two elements, a relationship that is not exempted from conflicting requirements and that will give rise to

²²⁸ Since V in expletive constructions is not transitive, a *v*-max projection should not be present (*v*-max substitutes AgrO). Nevertheless, for some authors, the existential NP (eNP) is analyzed as an object.

²²⁹ Following minimalist assumptions, Agreement node allows for a double specifier structure. As we will see, this type of structure provides an explanation of the so-called double subject constructions, as well as the different agreement relationships that are established within them.

different analyses, depending on the nature that a particular linguist attributes to both the expletive element and the existential NP. In any case, what seems clear is that expletive constructions do not have the semantic properties of overt-subject constructions (Chomsky 1999).

The complexity of this type of structure has not gone unnoticed in generative grammar and has received, in fact, different treatment in minimalist and pre-minimalist accounts. On the one hand, there is the nature of expletive elements themselves (*there*, *pro*, *il*) and the relationship they maintain with the existential NPs (eNPs) both in semantic and syntactic terms. On the other hand, and from a comparative perspective, there is the agreement between the verb and the subject/eNP complex, as well as the organization of the different features that are included in this type of constructions (existential, locative, etc.).

Pollock's (1989) analysis of auxiliary verbs and the predicate Loc (locative), together with Travis' (1984) insight on pleonastic elements and Belletti's (1988) proposal on unaccusatives licensing Case, provide the working basis for the minimalist approach to expletives. Based on these proposals, minimalist analyses unify and redefine certain properties of expletive constructions and provide an analysis that adapts itself to pre-minimalist approaches and to minimalist maxims themselves.

Following the framework of the minimalist program (MP), and more specifically one of the economy principles proposed by Chomsky (1993), Lasnik (1995) offers an analysis of expletive constructions which concentrates on two main ideas: the driving force for the movement of the expletive's associate (the eNP) and the licensing of the associate's Case.

A third idea to be considered is how agreement is achieved in these constructions, which is not as straightforward an issue as it may initially seem. Cardinaletti's (1997) nominative agreement hypothesis, Sobin's (1997) virus theory, Schütze's (1999) singular agreement and Kato's (1999) [+pronominal] agreement (Agr), among other proposals, are reviewed in this regard. Our analysis will then focus on two main issues: Case and agreement properties.²³⁰

Expletive elements like there have no semantic significance, which raises important questions about how the semantic and the syntactic component interact. From a syntactic perspective, our comparative analysis of there constructions focuses on issues such as agreement features, the question of Case, etc. From a semantic point of view, we will include Chomsky's principle of full interpretation and the choosing of lexical forms for each interpretation (including the presence of doublets), among other questions.

As background for our analysis, we will first present a very general typology of pleonastic elements, providing as clear a distinction as possible between there and it constructions in English, as well as between expletive there (including the locative features it is endowed with) and adjunct there. Once this is achieved, we will concentrate on the construction there is-are itself. In order to attain a complete analysis of there constructions, we will examine their behavior as far as V-movement and their status regarding Case and agreement. More specifically, we will concentrate on how each language presents different patterns, even though common ground can also be found.

²³⁰ Within the MP, movement in there constructions is directly related to Case and economy principles.

3.1.2. Pleonastic Elements

3.1.2.1. An Expletive Typology

Pleonastic elements or expletives are elements in NP positions which are not arguments and to which no theta-role is assigned. They are usually referred to as dummy elements that fill NP positions since they have no semantic significance. A central claim on pleonastics, made particularly by GB theory, is that they occur only in clausal subject position (Chomsky 1981). This position is projected syntactically and not thematically, and must therefore be filled when it has no semantic relevance, (a part of the EPP). The only NPs which can appear in non-thematic positions (subject position) are those which can have no semantic relation, as it in (3a), or are assigned one by some other verb, as in (3b) where he receives the thematic role from the verb leave:

- (3) a. it seems that he has left
b. he seems to have left

The examples in (4) illustrate the different cases of English, Spanish and French expletive constructions respectively.²³¹

- (4a) the dog/**it** is Victor's
it is raining outside
it surprises me that he is coming to visit us

²³¹ Sánchez-Lefebvre (2000), in her analysis of French, equates English there is/are constructions and French c'est / ce sont in sentences such as those in (i):

- (i) there is a dog in the garden there are dogs in the garden
c'est un chien ce sont des chiens

Her analysis is based on the explicit agreement shown in both languages. Nevertheless, here we consider the French expression il y a as the equivalent to the English there is/are because they share similar features of existentiality and location. As we will see, the implicit agreement in French il y a will parallel the Spanish in hay.

there appeared out of the shadows a large dog
there are 10 million inhabitants in this city

- (4b) el perro/**pro** es de Victor
pro está lloviendo
pro me sorprende que él vaya a venir a visitarnos
pro apareció por entre las sombras un perro enorme
pro hay 10 millones de habitantes en esta ciudad
- (4c) le chien/**il** est à Victor
il est en train de pleuvoir
il est surprenant qu'il vienne pour nous rendre visite
il est apparu parmi les ombrages un gros chien
il y a 10 millions d'habitants dans cette ville

According to the extended projection principle (EPP), all sentences must have a subject. This subject can either be a lexical subject, as is the case in both English and French, or a null element, as it occurs in Spanish. Thus, in the examples in (4a) and (4c), subject positions (in bold type) must be lexically filled regardless of whether one is dealing with referential, weather-type, verb-raising, unaccusative or existential constructions. English it equals French il, except for the unaccusative-V constructions, where French continues to use the il-form and English changes to the existential there (which is highly endowed with locative connotations, an attribute that it lacks entirely).

When analyzing the three paradigms, and in light of the examples in (4), the Spanish/French paradigm appears more homogeneous since the same subject form is used throughout the entire paradigm (*pro/il*). A consideration of the cases of raising and unaccusative structures, for example, shows that English presents two different forms (it, there), as in (5), while in Spanish/French, the same subject form

is maintained (*pro/it*), regardless of the syntactic nature of the preverbal element (either an NP or a clause (CI)):

- (5) there appeared [NP a dog]
 it surprises me [CI that he is coming]

The different forms used in the three languages can be summarized as in table (I):

Table I: the extended projection principle: English, French and Spanish			
	ENGLISH	FRENCH	SPANISH ²³²
referential	it	il	<i>pro</i>
weather V	it	il	<i>pro</i>
V(raising)-CI	it	il	<i>pro</i>
V(unaccusative)-NP ²³³	there	il	<i>pro</i>
	[lexical]	[lexical]	[empty]
existential constructions			
singular	there is	il y a	hay
plural	there are	il y a	hay

French and Spanish are both rich languages as far as morphology is concerned, but inflection (I) can be rich to different extents (Taraldsen 1980). In fact, taking Taraldsen's statement as a starting point, Travis (1984) elaborates further to propose the hierarchy shown in (6):

²³² Although *it* constructions and the equivalent constructions in Spanish fall outside of the scope of this thesis, it is necessary to add that, according to Suñer (1982a), Spanish pleonastic *pro* is not really *pro*, but rather \emptyset , since it can never be realized as a pronominal or nominal alternative. This is further developed in Kato (1999).

²³³ See Cardinaletti (1997) for an analysis of ergative-expletives. More in section 3.2.7.

- (6) I) if I is **very rich**, referential pronouns may drop,
 II) if I is **quite rich**, all pleonastics drop,
 III) if I is only **slightly rich**, only T-type pleonastics can drop.

This is illustrated in Spanish, English and French in (7):²³⁴

- | | | | |
|-----|----------------------|-------------------|----------------------------|
| (7) | <i>pro</i> come todo | <i>pro</i> llueve | <i>pro</i> llegó un hombre |
| | it eats everything | it is raining | there arrived a man |
| | il mange tout | il pleut | il est arrivé un homme |

Following this typology of constructions using pleonastic elements, a dual division can be established. On the one hand, lexical pleonastics and empty pleonastics involve a feature of specification of I. On the other hand, the it-type (I-type) *versus* the there-type (T-type) also reveal differences with regards to the [+ Case], and [+ #] features of the former and the [+ Case] feature of the latter.²³⁵ In this respect, three types of pleonastic elements can be distinguished, (there, it, *pro*), as exemplified in (8):

- | | | |
|-----|--|---------------------------------|
| (8) | there is a man in the garden | lexical [+ Case] ²³⁶ |
| | it is likely that he will come | lexical [+ Case] [+ #] |
| | <i>pro</i> aparece de repente un hombre en el jardín | empty ²³⁷ |

²³⁴ Spanish subject pronouns, as some Spanish grammarians have pointed out (Fernández Ramírez 1951, Gili Gaya 1973, etc), are only used for specific purposes; for instance, in order to convey emphasis or contrast. Thus, in a certain sense, they act as the counterparts to the French tonic pronouns (moi, toi, etc.), or the emphatic use of the English pronouns (YOU *versus* you; SHE *versus* she, etc.).

²³⁵ In Travis' (1984) terminology, [#] implies that the item with this feature may be either singular or plural, but at the very least carries a feature for Number.

The presence of these pleonastic elements can, in its turn, be correlated with a greater or lesser degree of richness of inflection in a language and, consequently, can be very much related to the null-subject parameter.

Thus, Travis' (1984) proposal, in which we include Spanish, can be summarized as in table (II):

Table II: inventory of referential and pleonastic elements in Spanish, English and French			
REFERENTIAL	PLEONASTIC ELEMENTS		
	I-type	T-type	
0	0	0	Spanish
1	1	1	English
1	1	→	French

In view of the Spanish examples, and in order to account for the facts in Spanish, pleonastic *pro*, which is absent from both English and French, must be introduced. This pleonastic *pro* is correlated with the null-subject parameter, since Spanish is a null-subject language, while English and French are not.²³⁸ Therefore, a typology of expletives has to include both overt expletives (there, it, il) and covert or vacuous expletives (*pro*). The presence of all of them complies with the EPP and, as place holders, they are nothing more than targets for movement.

The above comparison of pleonastic constructions in English, Spanish and French leads us to conclude that a relationship can be established between the types of pleonastic elements a language selects and the types of subjects it allows,

²³⁶ Under Chomsky's (1995) and Cardinaletti's (1997) analyses, among others, there lacks Case and phi-features. See the subsequent sections.

²³⁷ Even if it is a lexical pleonastic, French il is like Spanish *pro*.

²³⁸ We consider French to be a non null-subject language, following Zubizarreta (1998), among others. For an analysis of French as a null-subject language, see Roberge (1990) and Authier (1992).

together with the type of inflection ([+/- strong]) that characterizes it.²³⁹ Thus, in Spanish, inflection must be rich enough to identify referential NP's as well as both I and T-type pleonastics.²⁴⁰ In English and French, inflection identifies no NPs whatsoever.²⁴¹

3.1.2.2. There / It Contrast

In English there is a clear contrast between there and it, which exemplifies the two types of pleonastic elements, I-type and T-type, as in (9):²⁴²

- (9) it / *there seems [_{CI} that she cannot do it]
 there / *it was found under the tree [_{NP} a great treasure]

As shown in (9), the first striking difference lies in the fact that it can appear in a chain relationship with clauses (CI), while there can only appear in a chain relationship with noun phrases (NPs). Reuland (1983), among others, maintains that the division I-type/T-type depends on the sort of chain that is created, that is, on whether the pleonastic is coindexed with a CI or with an NP. But Travis (1984) disagrees with any theory that relies on chains and proposes an interpretation of Case assignment to the postverbal NP and agreement of the verb with the NP. In this sense, she is offering an alternative analysis to that of Pollock (1982), Safir (1982) and Reuland (1982); in fact, as we will see, Lasnik's (1995) analysis is based on that of Travis (1984) on Case assignment.

²³⁹ As we will see, this may be interpreted in terms of an optimal hierarchy (optimality theory).

²⁴⁰ Travis (1984) argues the same for Italian.

²⁴¹ However there is no one-to-one correspondence between the null-subject parameter and the presence of null pleonastic *pro* in a language, since, for instance, both Icelandic and German have null expletives, though Icelandic is a null-subject language and German is not. These languages possess two forms of expletives, null and overt, which are in complementary distribution.

²⁴² Our analysis will concentrate, nonetheless, on there pleonastics. For an analysis of both types of pleonastics see Rothstein (1995).

It is necessary to point out that a very interesting connection is made between the characteristics of the specific verb and the distribution of pleonastics, obviously taking into account the parametric differences that exist between the languages under study (English and Spanish/French). The question is not simply whether V requires an NP or a CI, but also whether other types of phenomena may intervene in the characterization of each particular structure. In this way, issues such as the theta-criterion, Case theory and agreement properties should also be taken into consideration in order to accurately account for the idiosyncrasies of each language.²⁴³ This ties in with the analysis of Verb-movement and proposals such as Pollock's (1989) verbal typology (more specifically the third group within this typology --auxiliaries and the predicate Loc--); and Chomsky's (1986, 1993), Lasnik's (1995) and Bošković's (1995) and proposals regarding the economy principles that affect such movement, as will be seen later.

As we mentioned before, there is a morphosyntactic difference between there and it: it is an NP that checks Case features and phi-features, while there lacks phi-features (Groat 1993). These properties then reveal a second contrast between there and it with regard to the features they carry. It, being an I-type pleonastic element, is the spell-out of the features [+ #] and [+ Case], while there, being a T-type pleonastic element, is simply the spell-out of [+ Case]. As we will see, the lack of phi-features in the case of there will have consequences for the agreement mechanism that operates in these constructions.

²⁴³ Both substitution and affixation analyses are intimately connected to the agreement properties in there constructions.

A third characteristic deals with the fact that, in accordance with Pollock's (1982) and Reuland's (1982) assumptions, the I-type is the strong pleonastic, while the T-type is the weak pleonastic, as indicated in table (III):²⁴⁴

Table III: Pollock's (1982) and Reuland's (1982) pleonastic classification		
	strong pleonastic [I-type]	weak pleonastic [T-type]
characteristics of the element	coindexed with a Cl [+ #], [+ Case] features	coindexed with an NP [+ Case] features
lexical choice	<u>it</u>	<u>there</u>

The basic idea is that, following Pollock's (1989) split inflection hypothesis, I (or more precisely Agr) must be linked to something stronger than just a T-type pleonastic. In other words, the pleonastic to which Agr can be linked must be sufficiently strong to bear the index of Agr.²⁴⁵

Apart from this, a distinction must be made between expletives that have Case and phi-features (the relevant features of which are erased, such as English it), and the pure expletives that lack these features and that do not erase the interpretable features (in English, there) (Chomsky 1995).²⁴⁶ As a consequence, the expletive construction will manifest verbal agreement with the associate precisely

²⁴⁴ As Chomsky (1998) notes, weak expletives share the basic movement/attraction properties of nominals. See further sections for movement in there expletive constructions.

²⁴⁵ Travis (1984), though disagreeing with the overall theory, admits that it can be effectively applied to French.

²⁴⁶ As we said before, a feature is a linguistic property. A feature is interpretable at the level of LF if it has semantic content. Uninterpretable features are, therefore, purely grammatical, formal. Thus, the phi-features of T (within IP) are uninterpretable and agree with the interpretable phi-features of a nominal, yielding, as we saw in chapter one, the surface effect of noun-verb agreement under IP.

when the expletive lacks Case and phi-features (English there, Spanish *pro*), but not when the expletive has a full array of features (English it, French il).²⁴⁷

3.2. Expletives: Preliminary Considerations

We will group the different properties of there existential constructions into semantic and syntactic approaches.²⁴⁸ The semantic approaches will center around two main issues: the economy principle of full interpretation and the idea of location, which is related to the appearance of lexical doublets. The syntactic properties of there constructions will include polemic issues such as Case, inflection/agreement and movement properties.

Before we attempt to define these properties, our first task will be to delimit the set of expletive constructions we are going to deal with. We will focus first on the three main constituents of there sentences. In this respect, we will deal with the element there and distinguish between adjunct, expletive and locative there, the verb to be in expletives, and the nature of the postverbal argument. We will also deal with different there constructions which are not existential but may superficially seem similar to existential there constructions. Ergative and presentational there sentences will also be included. Before proceeding to the semantic and syntactic analyses of there be existential constructions, an account of the types of expletives we will focus on will also be included.

²⁴⁷ Comparing English there and Spanish *pro*, a very interesting question may be posed: why should languages have overt expletives lacking Case and phi-features (as is the case with English there) instead of covert *pro* (as occurs in Spanish)? As Chomsky (1995) points out, the two forms are identical within the covert component. Therefore, the overt variant is used only when it is required for PF convergence.

²⁴⁸ There, as a pure expletive, lacks semantic features as well as formal features apart from its category D (Chomsky 1995). This has bearing not only on satisfying the FI but also on the movement analysis of expletives, as we will see later.

3.2.1. Existential Constructions in English and Spanish/French

The examples in (10) show the different constructions in each language where the underlined words are the expletives and those in bold type are the associates:

(10) there is **a book** on the table
are **books**

pro hay **un libro** en la mesa
libros

il y a **un livre** sur la table
des livres

In English, the expletive construction clearly reveals its three constituents: the expletive itself, with its locative value (there), the verb to be acting as the licenser of the associate's Case, and the associate a book. The agreement between the verb to be and its associate is overt, so that, as a general rule, when the eNP (the associate) is singular, the third Person singular form of the verb is used, whereas, when it is plural, the corresponding plural form applies.

In French, the expletive constructions present the same elements as they do in English except for the locative features of the expletive element y, which in French constitute an independent lexical item on its own, which does not occupy the subject position.²⁴⁹ As does there, il represents the syntactic subject, and avoir represents the unaccusative verb that licenses Case to the associate deux livres.

²⁴⁹ Hoekstra and Mulder (1990) argue that the French equivalent of there is y, both being locative adverbs. The difference is that y is a clitic adjoined to the finite verb, while there is moved to [Spec IP].

The case of Spanish is somewhat different, since all the features (expletive, locative, agreement features) seem to cluster into one form, hay.²⁵⁰

Hay is a crystallized verbal expression, uninflected with respect to grammatical Number (Kuno 1971). Etymologically speaking, it consists of ha (third Person singular present of haber, [to have]) and y (locative proform), which is parallel to French il y a, as in (11):²⁵¹

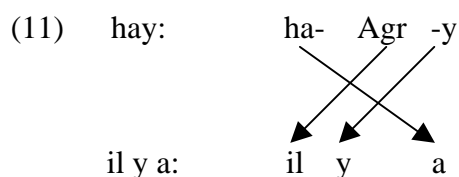

Along the same lines, Campos (1997) explains that existential there be is expressed in Spanish with the impersonal verb haber (to have). The present indicative form maintains the old locative clitic y (there).²⁵² However, non-present forms do not use the clitic y:

- (12) a. hay un estudiante en la sala
[there-is a student in the room]
- b. hubo muchos incidentes anoche
[there-was many accidents last night]
- c. habrá muchos problemas si continúa la huelga
[there-will-be-singular many problems if the strike continues]

To summarize, as opposed to what happens in Spanish and French, existential constructions in English are made up of two elements: the expletive and

²⁵⁰ One could argue that the EPP (the need for all sentences to have a subject at all levels in the derivation) is satisfied by the [- Agr] features of hay. Spanish, being a null-subject language, does not need to fill the subject position with a lexical item, as is the case with English there.

²⁵¹ Haber in modern Spanish is used only as an auxiliary verb and is not used as a transitive verb meaning to have (something) (Kuno 1971).

Impersonal haber in Spanish manifest the semivowel [j] in the 3rdps of present tense indicative mood (hay [there is/are]), as the phonetic representation of -y (Alcoba 1999).

the verb (be or unaccusative). Even though the two elements constitute a single unit, there seems to be a certain degree of independence, or at least of division, between them, so that while the expletive remains unchanged, the verb may change depending on the [+/- #] features of the associate. This happens neither in French nor in Spanish. In French, even though we are confronted with a structure similar to English (expletive + verb), there is no independence of the elements in the construction. Regardless of the [+/- #] features of the associate, the entire construction remains intact, including the verbal form. In the case of Spanish, the entire existential construction is reduced to one word which contains both the affix/expletive and the verb, so that, as a fixed form, no overt agreement with the associate is shown.²⁵³

3.2.2. Adjunct / Expletive / Locative There and Expletive / Referential *Pro*

Before dealing with expletive there, the distinction between expletive and adjunct there must be recalled.²⁵⁴ It is also necessary to stress that the expletive there, although it contains locative features (Pollock 1989, among others), has different properties from those of the locative there. In fact, in examples such as the one in (13) the expletive interpretation is blocked (Chomsky 1995):

(13) over there is a man in the room

²⁵² As Campos (1997) observes, the locative clitic still appears in equivalent constructions in Catalan (hi ha).

²⁵³ In certain varieties of Spanish, as we will see, there are cases of V-associate agreement, as in (i):

(i) habían tres libros en la mesa [there-were three books on the table]

²⁵⁴ The use of the term adjunct in this context is to be differentiated from its use in the previous chapter where the topic under discussion focused on the argument/adjunct dichotomy.

The structure in (13) can be compared to other structures in which the placement of a locative complement in initial position triggers SV inversion, for primarily emphatic or contrastive purposes.²⁵⁵

Another distinction must be made between the expletive there and the adjunct of place there. Such a confluence of different properties in the same lexical form finds a parallel neither in Spanish nor in French, since in these two languages different and distinct lexical items correspond to each property (il y a/là-bas; hay/allí). The differences between these two forms in English are presented in table (IV):

Table IV: expletive <u>there</u> versus adjunct <u>there</u>	
EXPLETIVE <u>THERE</u>	ADJUNCT OF PLACE <u>THERE</u>
<p>- cannot be questioned three pigs are escaping there are three pigs escaping *where are three pigs escaping? there</p> <p>- cannot be freely omitted in declaratives *are three pigs escaping</p> <p>- does not really contribute to the meaning of the sentence. Rather it is required for structural reasons, filling the subject position (EPP) three pigs are escaping²⁵⁶ there are 3 pigs escaping</p> <p>- cannot receive focal stress *<i>there</i> are three pigs escaping</p>	<p>- can be questioned I saw Bill there last week where did you see Bill last week? There</p> <p>- can be freely omitted in declaratives I saw Bill last week</p> <p>- is part of the (basic) structure of the sentence providing information about place he was there a minute ago he was reading a book there</p> <p>- can receive focal stress I saw him (right) <i>there</i></p>

²⁵⁵ This includes examples like the one in (i), taken from (Greenbaum and Quirk 1990):

(i) in a distant grave lies his beloved lady

²⁵⁶ This is an alternative sentence pattern in which the subject position may be occupied by the expletive element there (a non-argument element which fills an NP position and which, therefore, is required for structural reasons). Other examples include sentences such as those in (i)-(iii) which are offered by Haegeman (1994):

- (i) three accidents occurred after lunch
there occurred three accidents after lunch
- (ii) no medical help was available on the premises
there was no medical help available on the premises
- (iii) three more accidents occurred without there being any medical help available on the premises
there occurred three more accidents without there being any medical help available on the premises

As for Spanish, pleonastic *pro* differs from referential *pro* in that the former is obligatory, a fact previously stated by Chomsky (1982). Referential pronouns can be used for emphasis or to establish contrast, as in example (14); in the case of pleonastics no such dual possibility is available, and therefore the pronominal alternative is ungrammatical, as shown in (15):

- | | | |
|------|----------------------------|---|
| (14) | <i>pro</i> come mucho | [<i>pro</i> eat-3 rd ps a lot] |
| | él come mucho, pero yo no | [he eat-3 rd ps a lot but I don't] |
| | | |
| (15) | <i>pro</i> /∅ llueve mucho | [<i>pro</i> rain-3 rd ps a lot] |
| | *ello llueve mucho | [it rain-3 rd ps a lot] |

Silent *pro*-expletive (*pro*_{expl}), similar to there in English, inherits the features of the postverbal subject (Campos 1997). Also, this silent expletive which is equivalent to there appears every time a subject is inverted, whence the agreement between the verb and the inverted subject.²⁵⁷ Where the resumptive *pro* would have the phi-features of the moved element, the *pro*_{expl} would have no such features.²⁵⁸

3.2.3. Expletives There and *Pro*

The expletive there has three salient properties: first, an NP must appear in a certain formal relation to there in the construction, the element that is called the associate of the expletive by means of which the expletive is licensed; second,

²⁵⁷ The question of agreement in expletive constructions is a crucial issue that will be dealt with in further sections. See also Olarrea's (1996) and Ordóñez's (1997) preverbal and postverbal constructions.

²⁵⁸ Campos (1997) thus argues against Ouhalla's (1993) analysis of *pro* in expletive constructions as a resumptive *pro*.

Number agreement is not with there but rather with the associate; and third, there is an alternate form in which the associate is actually in the subject position after overt raising (Chomsky 1995). These characteristics are illustrated in (16):

- (16) a. there is [_{NP} a man] in the room (singular Agr)
 there are [_{NP} three men] in the room (plural Agr)
- b. [_{NP} a man] is in the room
 [_{NP} three men] are in the room
- c. *there was decided [_{CI} to travel by plane]
 *there is unlikely [_{CI} that anyone will agree]

Nevertheless, neither Spanish nor French expletive constructions have the last two properties. As shown in (17), there is no agreement between the expletives *pro/il* and their associates:

- (17) a. *pro* hay un libro encima de la mesa il y a un livre sur la table
 [there-is a book on the table]
- b. *pro* hay tres libros encima de la mesa il y a trois livres sur la table
 [there-is three books on the table]

Also, there seems to be no alternative form with the associate in subject position, as the examples in (18) show:

- (18) a. los tres libros están encima de la mesa trois livres sont sur la table
 [the three books are on the table]

- b. *los tres libros hay encima de la mesa²⁵⁹ *trois livres ont sur la table
 [the three books there-is on the table]

The raising of the associate NP triggers a change in the choice of copula. For some authors, this change is linked to the Case properties of expletives.²⁶⁰

As stated before, apart from these three characteristics, the expletive there is endowed with a series of properties which includes: 1) its occurrence in NP positions for which it is not subcategorized, that is, in the subject position of a sentence;²⁶¹ 2) the presence of an indefinite NP and 3) the presence of a restrictive type of verb in this type of construction (for instance, no transitives are allowed).

Within the MP, there bears Case but lacks agreement features. Groat (1993) offers a definition of the expletive there by saying that this category is a defective NP which lacks the phi-features for Person and Number but bears Case features.²⁶² This analysis supports the minimalist theory since it provides an example of the split between Case checking and agreement checking.

²⁵⁹ Notice that a construction like the one in (i) is only possible under certain intonational conditions with the NP associate as contrastive or emphatic focus:

(i) TRES LIBROS hay en la mesa
 [THREE BOOKS there-is on the table]

Torrego (1983) also mentions the fact that the postverbal NP cannot move to preverbal subject position. Examples such as the one in (ii) are only accepted under a topicalized intonation and carry contrastive stress:

(ii) VARIAS ARDILLAS había en el jardín esta mañana
 [SEVERAL SQUIRRELS there-was in the garden this morning]

²⁶⁰ See Tremblay (1997) and Dufresne, Dupuis and Tremblay (1995). See Dufresne, Dupuis and Tremblay (1995) for an analysis of Old French in which both have and be were allowed in existential sentences. In existential sentences with have, the associate NP appears with accusative Case, while in existential sentences with be, the associate NP appears with nominative Case.

²⁶¹ The positions a verb subcategorizes for are determined by the thematic structure of the verb. Whenever a verb requires a complement NP, it is because the verb has a theta-role to assign to the NP. Inserting an expletive NP in an object position would defeat the purpose, because the expletive element would not be able to receive the theta-role (Haegeman 1994).

²⁶² This offers support for Pollock's (1989) split inflection hypothesis since phi-features are checked by AgrS and Case features by T.

As one of the characteristics of there constructions, and from the examples in (19), it is clear that the existential pattern cannot be used with every verb:

- (19) three men bought a book
***there** bought three men a book
- trois hommes ont acheté un livre
***il y** ont acheté trois hommes un livre
- tres hombres han comprado un libro
* (\emptyset ha)-y han comprado tres hombres un libro²⁶³

The result is that by following Haegeman's (1994) reasoning, which is based on Belletti (1988) and Moro (1989), only a subset of one-argument verbs allows this type of construction, and this subset is represented by verbs of movement and (change) of state.²⁶⁴ These verbs are called unaccusatives since they fail to assign accusative Case and they lack an external theta-role.²⁶⁵

For Spanish/French, another interesting characteristic may be added to the nature of the proform in expletive constructions. The proform is never a subject (Freeze 1992). The examples in (20)-(23) illustrate this fact:

- (20) il y a deux enfants dans l'auto [there-is two children in the car]

²⁶³ Following Suñer's (1982a) proposal of \emptyset instead of *pro*, and considering the different features within the Spanish form hay, the only part that remains in this example is y (locative features), the verbal features (ha-) being substituted by han.

²⁶⁴ Burzio (1986) offers a list of such verbs, among which he includes the following: arrive, arise, emerge, begin, exist, occur... On unaccusatives see also Torrego (1989), Hoekstra and Mulder (1990), Labelle (1990), Levin and Rappaport (1995) and Mendicoetxea (1999).

²⁶⁵ Torrego (1989) provides an analysis of locative subjects in unaccusative there constructions and their corresponding Spanish ahí constructions:

- (i) there arrives your father ahí llega tu padre

- (21) a. il me semble que il y a du soleil [it seems to me that there-is sun]
 b. *il y semble avoir du soleil [there seems to be sun]
- (22) il n'y en a pas [there-not-it-is]
- (23) a. *pro* hay gente en el pasillo [there-is a crowd in the corridor]
 b. *pro* había gente en el pasillo [there-was a crowd in the corridor]

The nucleus of the expletive construction is the locative element *y* in Spanish/French, which is called expletive proform. The analysis is based on three main issues. First, the subject position is already occupied (*pro/it*), as in (20) and (23). Second, French *y* cannot move, thus suggesting that it is neither an argument nor in an argument position, as in (21b). Third, French *y* can be directly preceded by the negative and thus cannot be in the subject position, as (22) shows. Thus, subject position is never occupied by the locative element (*y*).²⁶⁶

The case of English in Freeze's (1992) crosslinguistic analysis is treated, therefore, as an exceptional one, since we do find lexically locative existential pronouns in subject position. So even if the English existential has been considered as the model for existentials in UG, it rather turns out to be an exception.

The nature of the subject in Spanish existential constructions clearly differs from the one in English, at least in lexical terms. *Pro* has been traditionally considered as the null subject in constructions like those in (14) and this has been extended to existential constructions like those in (23). Nevertheless, as we have

²⁶⁶ Of all the languages analyzed by Freeze (1992), English is the only language that presents the locative proform as a subject. The rest of the languages coincide in a non-subject position, as in the case of Spanish and French.

seen, the existence of *pro* as a null category has been questioned in these types of constructions. Suñer (1982a) points out that *pro* in these structures in Spanish is not really *pro* but rather \emptyset , since it is a category that will never be realized as a pronoun or a nominal substitute. Therefore, she defends the existence of *pro* and, at the same time, explains that *pro* can be referential but never existential. Also Kato (1999) dispenses with *pro* and gives [+pronominal] Agr the status of weak pronouns. Adopting these proposals, the subject in existential constructions in Spanish is [+pronominal] Agr and not *pro*. Agr category is, therefore, crucial when defining the nature of Spanish subjects. We will see its effects in existential constructions in subsequent sections.

3.2.4. The Status of V

The verb haber in Spanish is an impersonal verb. Following Fernández Soriano and Táboas Baylín (1999), impersonal verbs fall into two categories: 1) impersonal verbs with an undetermined subject, as in (24); and 2) impersonal verbs with no grammatical subject, such as hay in (25):

(24) a. comer con los dedos es de mala educación

[eat-infinitive with your fingers is bad manners]

b. si comes mucho engordas

[if eat-2ndps a lot gain-weight-2ndps] [if you eat a lot you gain weight]

(25) hay más comida en el frigorífico

[there-is more food in the fridge]

This second group includes verbs that are semantically defective in the sense that they have no argument structure. This way, they cannot be assigned a logical subject. That is why they differ from the verbs in the constructions analyzed in chapter two.

The English expletive constructions in our analysis contain existential be (eBE). Existential be is obligatory in clauses where an existential NP (eNP) is present.²⁶⁷ This is so since eBE is necessary in order to assign Case to the eNP. Evidence for such a relation is given through an analysis of small clauses (SC) such as those in (26) (Lasnik 1996):

- (26) a. I want someone (to be) here at 6:00
b. I want there to be someone here at 6:00
c. *I want there someone here at 6:00

The optionality of to be in (26a) is due to the presence of want, which assigns Case to the NP someone. In contrast, when the expletive element appears, to be must be present in order for the sentence to be grammatical, as it is shown in (26b) and the ungrammaticality of (26c).²⁶⁸

Be is a verb that assigns no theta-role (as opposed to theta-assigning verbs such as want, consider, etc.), but does assign accusative Case to the NP. Therefore, a Case relationship is established between be and its associate, the eNP.

²⁶⁷ As previously mentioned, verbs other than be can be present in existential there constructions, as the examples in (i) show:

- (i) there arrived a man
there arrived a bus

Nevertheless, these unaccusative constructions are somewhat marginal.

²⁶⁸ Moro (1991) and Lasnik (1996) have pointed out that existential there constructions force the obligatory realization of the copula.

For an analysis on the structure of existential be, Travis (1996) relies on Ritter's (1988) proposal for the equivalent verb in Hebrew. Ritter (1988) suggests that the existential verb to be forms a two-part VP which has the effect of creating an argument-like relationship between this verb and the eNP. Consequently, the verb is allowed to assign the eNP inherent partitive Case (as Belletti also suggests).

The two-part VP proposal is exemplified in the diagrams in (27):

(27) [VP [V' [V is_i] [VP2 [NP a man] [V' [V t_i] [PP in the room]]]]]

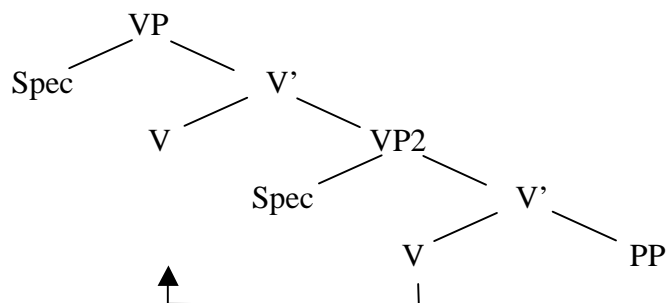

The new lower VP has two salient properties: on the one hand, the lower verb in this VP has no Case-assigning abilities. In order for this verb to be able to assign Case, it has to move to the higher V. On the other hand, VP2 has no position to which the external theta-role may be applied. It is due to these two properties, and this connection to nominal heads, that this bottom VP (VP2) is called VnP (a verbal noun or a nominal verb) (Travis 1996).

Such a VnP analysis will also account for the difference in the structure of passive be (pBE) and existential be (eBE) (Travis 1996); this is shown in (28):²⁶⁹

(28) [V' [V eBE_i [VnP [NP NP-theme] [V' [V t_i] [XP PRED]]]]
 [V' [V pBE] [FP NP [F' [F Vn_i] [VnP NP-theme [Vn' [Vn t_i] XP]]]]

In both structures (eBE and pBE), the verb to be selects a VnP (which in the case of pBE is contained in a functional category FP). As far as Case is concerned, there are two main issues which also affect the two structures: on the one hand, only one position can receive partitive Case; on the other hand, such a position must be an argument of the Case-assigning head, that is, an argument of to be. In the bracketing presented above, this position is occupied by the NP-theme, which is the one receiving partitive Case from to be, though it does so in two different ways depending on whether the structure (and be) is passive or existential.

Existential be assigns Case to its theme argument directly, as in (29):

(29) $[_{V'} [_{V} eBE_i [_{VnP} [_{NP} NP\text{-theme}] [_{V'} [_{V'} t_i] [_{XP} PRED]]]]$

In passive be, there is a restructuring mechanism operating, by means of which Case is passed from the higher verb pBE to the object of the lower verb NP-theme in VnP, as in (30):

(30) $[_{V'} [_{V} pBE] [_{FP} NP [_{F'} [_{F} Vn_i] [_{VnP} NP\text{-theme} [_{Vn'} [_{Vn} t_i] XP]]]]$

Partitive Case is passed from pBE to the Vn head; this is how the Vn head may then assign partitive Case to its theme-argument.

The examples below show the contrast between eBE and pBE in English and Spanish/French:²⁷⁰

²⁶⁹ FP stands for functional phrase. Travis (1991, 1996) argues that there is an intermediary category in passive constructions that is an aspect phrase, which can show agreement with the object.

²⁷⁰ Taken from Sportiche (1990) and Travis (1996).

- (31) a. there were three men killed eBE
 b. il y a eu trois hommes tués
 [there-has-been three men killed]
 c. había un libro puesto sobre la mesa
 [there-was a book put on the table]

- (32) a. il est tués trois hommes pBE
 [there-was-killed three men]
 b. ha sido puesto un libro sobre la mesa
 [there-has-been-put a book on the table]

The examples in Spanish and French clearly reveal that existential be/haber and passive be/haber are not the same, since these languages select a different lexical item in each case: existential haber/avoir (había/il y a) and passive ser/être.

It is important to note also that in the three languages, existential be cannot be used as a restructuring verb:²⁷¹

- (33) *there were killed three men
 *había puesto un libro sobre la mesa [there-was put a book on the table]
 *il y a eu tués trois hommes [there-has-been killed three men]

²⁷¹ As Nathan (1981) and Schütze (1999) point out, a distinction should be made between copular be and auxiliary be:

(i) **there's** four soldiers in the room
 *what's the soldiers **doing**?

That is, partitive Case cannot pass through the participial to the NPs three men, un libro and trois hommes. Table (V) and the examples in (34) below show the different characterization for the languages under analysis:

Table V: existential BE and passive BE in English, Spanish and French		
	Spanish / French	English
eBE	no restructuring mechanism	no restructuring mechanism
pBE	restructuring mechanism	no restructuring mechanism
lexical choice	<u>haber</u> / <u>être</u> , <u>avoir</u>	BE

(34) eBE: there were three men **killed**

había un libro **puesto** sobre la mesa

[there-was a book put on the table]

il y a eu trois hommes **tués**

[there-has-been three men killed]

pBE: *it/there/they were killed three men

ha sido puesto un libro sobre la mesa

[there-has-been-put a book on the table]

il est tués trois hommes

[there-is killed three men]

English, Spanish and French each present a different V entering in existential constructions. Nevertheless, in spite of the different lexical choices of the verb, the three share the same characteristics, namely the assignment of

partitive Case to the eNP (as well as the limits for the application of the restructuring mechanism).

Another difference between eBE and pBE focuses on Case. Belletti (1988) assumes that all verbs have the capacity to assign partitive Case (inherent or structural) while accusative Case is only assigned by some verbs.²⁷² So, for example, a passive verb loses its ability to assign accusative Case while retaining its ability to assign partitive Case. Thus, unaccusative verbs assign partitive Case and accusative verbs assign both accusative and partitive Case.

Lasnik (1996) attempts to parametrize partitive Case assignment in English and Italian and he arrives at the following formulation (we extend to Spanish the analysis of Italian in this proposal). Taking evidence from Turkish (Enç 1991) and Hebrew (Chenauksy 1990), Lasnik (1996) defends that in all languages verbs may have multiple Case-assigning abilities. Unifying this with Belletti's (1988) proposal, verbs can assign both accusative and partitive Case. The parametric difference between English and Italian/Spanish is in passive constructions: while in Italian/Spanish only the assignment of accusative Case is blocked, in English both accusative and partitive Cases are blocked.

Lasnik (1996), making use of Borer's (1984) and Chomsky's (1991) idea that parametric properties are located exclusively in the functional portion of the lexicon, attributes the locus of this parametric variation to a functional element (the passive morpheme). Therefore, in Italian, passive verbs lose their ability to assign accusative Case, as in English, but at the same time, the passive morpheme in Italian has partitive Case associated to it which is not true of English. The situation

²⁷² See Belletti (1988) on how partitive Case, being inherent, cannot be assigned into a small clause; see Travis (1996,) on how this fits into an analysis of expletive constructions that contain a small clause.

is then as follows in table (VI), which includes Lasnik's (1996) and Travis' (1996) proposals:²⁷³

Table VI: parametric variation and V		
	Italian and Romance (Spanish)	English
existential sentences	partitive Case	partitive Case
passive sentences	- partitive Case in passive morpheme - restructuring mechanism	- no Case - no restructuring mechanism
accusative sentences	partitive and accusative Case	partitive and accusative Case

Following optimalistic premises, we may view this entire discussion not only as a question of blockage properties (Lasnik 1996), but also as different hierarchical organizations in the different languages. In optimality theory, as was previously said, language variation is seen as differences in constraint rankings.

When dealing with verbs assigning Case, we may say that there are certain constraints regarding the assignment of accusative Case and partitive Case. It is the particular way in which each language ranks these constraints that will bring about and explain the differences between them. For Romance, the ranking would appear in (35), while the English ranking would be that shown in (36):

(35) Romance: PARTITIVE CASE >> ACCUSATIVE CASE

(36) English (passives): ACCUSATIVE CASE >> PARTITIVE CASE

²⁷³ Notice that for Travis (1996) the parameter which distinguishes Romance from English is explained in terms of the restructuring mechanism which allows for Case to be passed from a higher

The implications are that, on the one hand, accusative Case in Romance presupposes partitive Case, as is the case in accusative sentences; but partitive Case does not imply the existence of accusative Case, as occurs in existential sentences. Following Belletti (1988), the same seems to be true of English in that all verbs can assign partitive Case. Nevertheless, in English, the non-applicability of accusative Case in passive sentences brings about the non-applicability of partitive Case. Since accusative Case is never present in existential sentences in English, no such hierarchy applies and, as far as partitive Case is concerned, they behave in the same way as their Spanish, French, and Italian counterparts. In accusative and passive constructions, the [+ /-] implication of accusative Case is what brings about the Case hierarchy in (35)-(36) above.

3.2.5. A Typology of NPs

Abbott (1997) offers a typology of there constructions attending to the different category types for the postverbal NP (XP).²⁷⁴ This is exemplified in (37):

- | | | |
|------|---|------------------------------|
| (37) | a. there is no solution | XP = NP |
| | b. there were several people shooting at me | XP = NP+VP (-ing) |
| | c. there were several people shot | XP = NP+VP (past participle) |
| | d. there were several people in the room | XP = NP+PP |
| | e. there were several people sick | XP = NP+AdjP |

verb to the object of a lower verb.

²⁷⁴ Her analysis is mainly based on there constructions with have, which she analyzes as small clause structures.

The various analyses of expletives show two different approaches to the postverbal NP. For Jenkins (1972, 1975) and Williams (1984), among others, the postcopular material in there constructions is an NP; while for Safir (1982), Burzio (1982) and Stowell (1981), among others, such an NP should rather be analyzed as a small clause.²⁷⁵

A series of five arguments can be given for the NP analysis (Williams 1984):

- all NPs can enter into a construction of the type there-be-NP, as in (38):²⁷⁶

(38a) there is someone sick
 someone believed to be a liar
 someone running

(38b) hay alguien enfermo
 alguien de quien se opina que es un mentiroso
 alguien corriendo

- there constructions terminate in NPs and NPs cannot terminate in NPs; there constructions under the NP analysis thus comply with both requisites, as in (39a)

²⁷⁵ The small-clause analysis was proposed by Stowell (1981) for examples such as those in (i):

(i) there is [_{SC} a man in the room]

See also Safir (1987a) and Travis (1996); for a criticism of this analysis see Williams (1984).

The same small clause structure is used by Abbott (1997). Under her analysis, examples with singular finite verb agreement such as those in (34a) are explained in terms of the associate being a proposition (propositions normally trigger singular agreement).

The analysis of existential constructions in terms of small clauses also provides an explanation for cases of agreement mismatches, as in (ii):

(ii) there's three men in the room

For Dikken (1995) and Belvin and Dikken (1996), the associate of there is the entire small clause three men in the room. The verb in this case agrees with the associate which is, therefore, singular. Nevertheless, the analysis of the lack of agreement in existential constructions must be examined further.

For more on small clauses see Sportiche (1990), Mahajan (1990), Johnson (1991), Travis (1991) and Contreras (1995). See also Johnson (1991).

²⁷⁶ For an analysis of conjoined NPs and agreement in expletive constructions see Sobin (1997). It should be noted that in the MP, the Case of each NP is checked via Spec-head agreement. Therefore, NPs that are coordinated present a special problem. It is worth pointing out that NP associates can also be conjoined as well.

and (40a). This does not affect small clauses, as the examples in (39b) and (40b) show:

- (39) a. *there was a friend of mine an impostor
b. I consider [_{SC} a friend of mine an impostor]

- (40) a. *hay un amigo mío un impostor
b. considero [_{SC} a un amigo mío un impostor]

- distribution of the preposition with: PPs cannot be an eNP or small clause predicate, they must be part of the eNP, as in (41) and (42):

- (41) there is a man with a green coat
the man with a green coat is here
*the man is with a green coat

- (42) hay un hombre con un abrigo verde
el hombre con el/del abrigo verde está aquí
*el hombre está con el/del abrigo verde

- eNPs cannot be fronted by wh-movement, as in (43a) and (44a), since happy/feliz is part of the eNP someone/alguien. This extraction is possible in small clauses, as in (43b) and (44b):

- (43) a. *how happy was there someone?
 b. how happy do you consider Bill?

- (44) a. *¿cómo de feliz hay alguien?
 b. ¿cómo de feliz crees que es Bill?

- heavy NP shifts which are possible in small clauses are not permitted in there + aux + NP structures, as in (45) and (46):

- (45) a. there are [_{NP} several of George's recent acquaintances sick]
 *there are [_{NP} sick several of George's recent acquaintances]
 b. I consider [_{SC} several of George's recent acquaintances sick]
 I consider [_{SC} sick several of George's recent acquaintances]

- (46) a. hay [_{NP} varios de los amigos nuevos de Jorge enfermos]
 hay [_{NP} enfermos varios de los amigos nuevos de Jorge]
 b. considero [_{SC} a varios de los amigos nuevos de Jorge desagradables]
 considero [_{SC} desagradables a varios de los amigos nuevos de Jorge]

The previous arguments hold both in the case of English and Spanish. Nevertheless and as the examples in (45a) and (46a) show, heavy empty shifts behave differently in English and Spanish expletive constructions: Spanish allows heavy empty shifts in expletive constructions, as in (46a), but these are not permitted in their English counterparts, as in (45a). Although this needs to be further analyzed, a first explanation for this fact may be found in the freer order of constituents in Spanish

than in English that, as we have seen in chapter two, allows NP subjects (SV/VS) and NP objects (VSO/VOS) to have different positions in the sentence. To this we may add the different nature of the eNP in English and in Spanish as far as agreement is concerned: English may restrict the position of the eNP which is the element triggering the agreement to a position closer to V. We will deal with the question of agreement in existential constructions later.

In the present study, we will adhere to the NP analysis. In any case, in English, Spanish and French, postverbal NPs must be indefinite, as indicated in the examples in (47):²⁷⁷

- (47) there arrived a/*the man
pro ha llegado un/*el hombre²⁷⁸
 il est arrivé un/*l' homme

The DE consists of imposing an indefiniteness requirement on the i-subject (inverted-subject) of unaccusative verbs, as indicated in the examples in (47).²⁷⁹

²⁷⁷ As we will see, following Belletti's (1988) account of partitive Case in pleonastic constructions, the NP must be indefinite, since partitive Case will convey the meaning "some". Milsark (1977) had already proposed an existential quantifier hidden in the expletive there.

Another explanation for the indefiniteness property of the associate NP is offered by Diesing (1992), according to whom non-specific indefinites must stay within the domain of VP while definites and specific indefinites must be outside of VP at LF.

²⁷⁸ The definite NP is only possible in certain contexts under a pragmatic analysis. See Milsark (1974), Ariyoshi (1980), Suñer (1982b), Ziv (1982), Abbott (1993) and Ward and Birner (1995) for these cases of a definite NP; also Leonetti (1999) for haber/estar in terms of indefinite/definite NP.

²⁷⁹ The DE is a property of the object position of the relevant class of verbs due to their Case properties. For further information on the definiteness restriction (DR), the predicate restriction (PR) and on the NP restriction see Milsark (1974, 1977), Stowell (1978), Safir (1982, 1985, 1987b), Pollock (1983, 1984), Burzio (1986), Enç (1991), Diesing (1992), Groat (1993), Birner and Ward (1994) and Ward and Birner (1995). See Safir (1982) and Reuland (1983) for a syntactic treatment of DE. See Higginbotham (1987) for a semantic treatment. Szabolcsi (1986) tries to combine both a syntactic and a semantic approach to DE.

This construction can also occur with a particular set of verbs referred to as inside verbals (Milsark 1974); these include items such as arise, develop and happen, as in (48):

- (48) there arise typhoons here
there developed a serious problem

These verbs coincide with Burzio's (1986) ergative verbs.

There are also cases in which the DE is neutralized, but these are either due to specific syntactic structures or restricted to certain varieties within a language.²⁸⁰

The definiteness effect is neutralized when a relative clause appears (Browning 1987, Fernández Soriano and Táboas Baylín 1999, among others) and in cases where a superlative appears (Masullo 1996). The relevant examples are in (49):

- (49) a. este año hay los mismos problemas que había el año pasado
[this year there-is the same problems que there were last year]
b. en esa tienda hay el mejor café de Colombia
[in that store there-is the best coffee of Colombia]

The internal argument of the verb in these structures cannot have a specific or referential reading: verbs in these structures require a purely existential reading for their internal argument (theme).

²⁸⁰ Holmback (1984) argues, with examples such as that in (i), that no simple syntactic account of the DE is possible:

(i) there is the outline of a human face hidden in this puzzle

Also, when there is used to introduce a list, the NP can be definite, as in

(50) (Bennett 1996):²⁸¹

(50) - what can we eat?

- well, there's the paté, the pot noodle, the remains of yesterday's stew and
the ham in the fridge

The heaviness of the eNP also plays an important role in the DE, as in (51)

(Safir 1982):

(51) a. there hung a coat on the wall

b. there hung on the wall the flag of the country that John had fled

The NP a coat in (51a) occupies the object position of the inside verbal hung.

However, that is not the case in (51b) where the heavy NP has been moved and occupies a position that is external to the VP (see also Belletti 1987). In fact, the associate must be heavy, otherwise the sentence will not be correct, as in (52):

(52) *there hung on the wall the flag

Other examples, such as the ones in (53), are explained following distinction between “referring to a type” and “referring to a token” (Vergnaud and Zubizarreta 1992):

²⁸¹ For more on the so-called list existentials and DE, see Milsark (1974), Abbott (1992) and Ward

- (53) a. en la librería ya había el último libro / manual de Chomsky
 [in the library already there-was the last book / handbook of Chomsky]
- b. en la librería ya había ejemplares del último libro / manual de Chomsky
 [in the library already there-was copies of the last book / handbook of Chomsky]
- c. *en el muelle había el capitán / el perro / el barco
 [at the dock there-was the captain / the dog / the ship]
- d. *en el muelle había ejemplares del capitán / el perro / el barco
 [at the dock there-was copies of the captain / the dog / the ship]

All the PPs that can enter in the complement position can be translated as something like copies or issues of X, where X = DP. In general, every nominal construction refers to a type that determines membership to the class of books, the class of manuals, etc. By entering in a DP complement position, an NP normally fixes its reference to a specific token of a class. Note that not all instances of definite determiners serve to transform the reference to a type into the reference to a token.

Counterexamples for the DE are also present in some Spanish dialects, (Longa, Lorenzo and Rigau 1998):

- (54) en la biblioteca hay el manual (Northwestern Spanish)
 [in the library there-is the handbook]

and Birner (1995).

3.2.6. Existential and Presentational There Sentences

It should be noted that there is a difference between existential and presentational there sentences (Milsark 1974, Aissen 1975, Safir 1985, Lumsden 1988 and Rochemont and Culicover 1990). The relevant semantic and syntactic characteristics are summarized in the following table (VII) and the examples below.²⁸²

	EXISTENTIAL <u>THERE</u>	PRESENTATIONAL <u>THERE</u>
position	the associate NP is in an A-position ²⁸³	the associate NP is in an A-bar position
DE	they exhibit the DE - *there was the one man she had no desire to see in the room	no DE applies - there walked in the room the one man she had no desire to see
V	they allow a more restricted set of verbs - *there walked a unicorn into the room	they allow a larger set of verbs - there walked into the room a fierce-looking unicorn
focus	the associate need not be focused - where did you hear a lot of noise? there was a lot of noise in the kitchen	the associate must be focused - where did his favorite brother stand? *there stand beside him his favorite brother
extraction	extraction is possible - what did he say there was on his desk?	extraction is blocked - *what did he say there stands on his desk?
heaviness	they have no heaviness requirement on the associate - there was a man in the room	they have heaviness requirement on the associate - ?*there ran into the room a man - there ran into the room a man who turned out to be the nation's most wanted criminal

The difference between expletive and presentational there extends also to the domain of agreement, as the examples in (55) and (56) show:

²⁸² Based on Schütze's (1999) analysis.

²⁸³ In order for the associate NP to get Case from be (Lasnik 1995), it must be in an A-position. If we follow Lasnik's (1995) analysis, another difference would have to be added to table (VII), since

- (55) there are two portraits of the old man hanging over the fireplace Agr
 there's two portraits of the old man hanging over the fireplace non-Agr
- (56) at the old Winthorpe mansion, there hang over the fireplace Agr
 two portraits of the man who founded this great company Agr
 *at the old Winthorpe mansion, there hangs over the fireplace ... non-Agr

In the case of expletive there, both agreement and non-agreement constructions are allowed, as in (55). Nevertheless, presentational there only allows those constructions which show agreement with the associate NP, as the examples in (56) show.²⁸⁴ Agreement in expletive constructions will be dealt with in later sections.

3.2.7. Ergative-expletives and Existential-expletives

When dealing with expletive constructions, it is important to distinguish between ergative-expletives and existential-expletives.

Cardinaletti (1997) provides an analysis on this type of structure and offers the following examples of expletive constructions with ergative verbs for English, Italian and French respectively (in this case Italian parallels Spanish):

- (57) a. **there** *arrives / arrive three girls
 b. **pro** *arriva / arrivano tre ragazze
 pro *llega / llegan tres chicas
 c. **il** arrive / *arrivent trois filles

in presentationals the associate is forced to be in a chain relationship with the subject there in order to satisfy the Case filter (Schütze 1999).

²⁸⁴ Belvin and Dikken (1997) provide an analysis of presentational there constructions with the experiencer have in terms of small clauses:

(i) there walked a strange man into my office

Constructions such as the one in (57a), which are cases of ergative-expletives, should be explained separately from those in (58) which correspond to existential-expletives:

- (58) a. there are three men in the room
b. there´s three men in the room

The two main differences between these two types of expletives relate to agreement properties and control. As the example in (57a) reveals, ergative-expletives have only one possible agreement relationship, either eNP-V agreement (as in English and Italian/Spanish, or S-V agreement (as in French) irrespective of the Number of the associate. Under certain circumstances, existential expletives, on the contrary, seem to allow two types of agreement relationships, as in (58). The question of agreement will be seen in subsequent sections.

The control generalization as analyzed by Cardinaletti (1997) does not hold for existential-expletive constructions. Consider the examples in (59) and (60):

- (59) there entered two men without PRO identifying themselves

pro han entrado dos hombres sin *nisiquiera* PRO identificarse

- (60) *there are two men in the room without introducing themselves

**pro* hay dos hombres en la habitación sin *nisiquiera* PRO identificarse

The associate two men in (59) can control the subject PRO of the clause identifying themselves: the agreeing associate raises covertly to a preverbal position to check

I had a strange man walk into my office

the phi-features on the verb; it lands in a position from which it can c-command the PRO subject of the embedded clause. In contrast, the example in (60) reveals that the correlation between agreement and control does not work for existential-expletive structures.

The case of Spanish is illustrated in the examples in (61):

- (61) a. *?*pro* hay tres hombres sin PRO saber qué hacer
b. *pro* hay tres hombres que no saben qué hacer

The sentences in (61a) may not be accepted by all speakers, but, on the contrary, if a relative clause is used, as in (61b), and no control operates, the sentence is grammatical and accepted by all speakers.

3.3. Semantic Properties

3.3.1. Existential Constructions and the Predicate Loc

Existential constructions are characterized by the presence, either overt or covert, of an expression with a special-temporal meaning, a so-called locative. The overt realization of the locative may be achieved either by means of an element in subject position (English there), a locative clitic (French *y*) or an element integrated with time morphemes (Spanish *-y*). Covert realizations are exemplified in forms of Spanish haber other than the present tense hay (había, hubo, etc.). This locative element is crucial in these constructions since it works as the logical subject in the sense that something is predicated about it (Fernández Soriano and Táboas Baylín 1999).

As part of the semantic properties of there constructions, it is necessary to address the possible relationship that could be established between these

constructions and theta-theory. We will present an analysis based on Pollock's (1989) verbal typology, which is closely related to V-movement, in order to put in perspective the role that theta-theory plays in existential constructions.

3.3.1.1. Pollock's (1989) Verbal Typology

Pollock (1989) establishes a close connection between theta-theory and the theory of V-movement. His parameter of the opacity/transparency of AgrP accounts for the variation between languages such as English and French. Languages that have a rich morphology (such as French, Spanish and Italian) will have a transparent AgrP, which means that this transparent node allows the theta-role to be assigned by the verb to its constituents. Due to the poor morphology, in languages such as English, AgrP will be opaque to theta-role assignment. It will be in opaque Agr languages where restrictions are found as to the type of verbs that can truly undergo V-movement without producing any violation of the theta-criterion and thus give rise to ungrammatical sentences. Together with the different type of morphology in every language, the [+/- finite] dimension is added to complete the table of restrictions on V-movement as shown in table (VIII):

Table VIII: relationship between Agr and theta-role assignment		
transparent AgrP	rich morphology, [+ finite]	Spanish/French type
opaque AgrP	poor morphology, [+ finite]	English type
	[- finite]	Spanish/French/English type

According to Pollock's (1989) proposal, there are three different types of verbs:

1. Verbs that assign theta-role and that, as a consequence, cannot undergo Verb-

movement when AgrP is opaque (since they would otherwise violate the theta-criterion). Examples belonging to this group are presented in (62) both in English and in French/Spanish:

- (62) V-movement: Jean embrasse souvent Marie
 [NP_i [[embrasse] [t_i] [souvent t_i Marie]]]
- Juan abraza a menudo a María
- no V-movement: John often kisses Mary
 [NP [often kiss Mary]]
- *John kisses often Mary
- Juan a menudo abraza a María
- no V-movement: not to seem happy ...
- ne pas sembler heureux ...
- no parecer feliz ...²⁸⁵

2. The second group consists of those verbs that do not assign theta-role and therefore can move without causing any violation of the theta-criterion (aspectual be/être and have/avoir, and "passive" be/être), as the examples in (63) reflect:

- (63) V-movement: John is always happy
 John est toujours heureux
 Juan está siempre contento
- V-movement: not to be happy ...
 ne pas sembler heureux ...
 no parecer/estar siempre contento ...

²⁸⁵ Spanish, as well as Italian, does not have any such contrast between the order of negative adverbs in finite clauses and their order in infinitives, as indicated in examples (i-ii):
 (i) Juan no come mucho [Juan not eat-3rdps much] [Juan does not eat much]

3. A third group would include certain uses of auxiliary verbs, such as existential be/être and lexical have/avoir. These verbs can undergo Verb-movement even though their complements must be theta-marked. The corresponding examples appear in (64):

- (64) a. to be there or not to be there
 être là ou ne pas être là ... [PRO (ne) T pas V-max être_i [e_i là]] ...
 estar allí o no estar allí
- b. John has a car Loc
 Jean a une voiture Loc
 Juan tiene un coche Loc

It is with this third group that the overt/covert locative predicate Loc is introduced, a predicate which will be responsible for the assignment of theta-roles. The connection that exists between this third group of verbs and a locative value is reflected in English, and in Spanish and French.²⁸⁶

3.3.1.2. Location and Auxiliaries Have/Tener/Avoir

It is clear that the R-expressions contained in the sentences in (64) must be theta-marked by predicates other than the moved verbs²⁸⁷. This is the role played by Loc in existential constructions. Examples like those in (65) show that the presence of a locative element is not only possible in existential sentences, but it is also present in other structures, for instance, with the verbs have, tener and avoir

(ii) no comer mucho... [not eat-infinitive much ...]

²⁸⁶ As Lyons (1967) maintains, existential and possessive (to have) constructions derive (both synchronically and diachronically) from locatives. The connection between existential and locative sentences is reflected in the occurrence of an originally deictic particle in existential constructions. See also Lyons (1977), Bresnan (1988) and Bresnan and Kanerva (1989).

²⁸⁷ R-expressions or referential expressions, as opposed to pronominals or anaphors, are those NPs which are inherently referential and which, therefore, do not need an antecedent.

with an NP subject as in (65a), (66a) and (67a) (Pollock 1989 and Torrego 1989, among others). Therefore, it is possible to find a relationship between certain verbs and the concept of location (whether overt or covertly expressed), as in the following pairs (65)-(67):²⁸⁸

- (65) a. this city has 10 million inhabitants Loc overt Loc
 b. **there** are 10 million inhabitants in this city overt Loc
- (66) a. esta ciudad tiene 10 millones de habitantes Loc covert Loc
 b. hay 10 millones de habitantes en esta ciudad overt Loc
- (67) a. cette ville a 10 millions d'habitants Loc covert Loc
 b. il y a 10 millions d'habitants dans cette ville overt Loc

Therefore, the locative presence may or may not be overt (there/-y/y). In the case of an overt Loc, there seems to be a doubling relation between the expletive there/-y/y and the adjunct predicate in this city/en esta ciudad/dans cette ville (Hoekstra and Mulder 1990). The presence of the covert locative Loc may find syntactic and semantic support in the correlation between tener/haber in Spanish and have/there is-are in English. In this sense one perceives a connection between have/tener and location. This relationship may in some cases be overtly paralleled with the corresponding pair haber/there is-are, which reveals the actual lexical locative. This

²⁸⁸ Torrego (1989) argues for a semantic connection between locatives and existential sentences. She also analyzes this double possibility in (65-67) by arguing that ordinary unaccusatives must, in fact, have a hidden locative which corresponds to the overt locative subject. This occasionally hidden locative argument is analyzed as the D-argument of existentials and other unaccusative

presents a successfully valid semantic doublet since, even though they have different syntactic representations, their semantic interpretations are similar.²⁸⁹

In the case of French, apart from maintaining the locative predicate, the same auxiliary verb is present in both structures. Thus the verb avoir appears in sentences with overt Loc and in sentences with covert Loc. As previously mentioned, in contrast, English and Spanish present two different kinds of verbs.

Kuno (1971) maintains that existential sentences have locatives in the sentence-initial position so that the basic word order is that shown in (68).²⁹⁰ He provides evidence for this hypothesis in English, French, Spanish, Russian, Chinese and Turkish:

(68) locative + V_{exist} + NP_{indef.}²⁹¹

verbs. See also Fernández Soriano and Táboas Baylín (1999) and references therein, for haber/estar alternance.

²⁸⁹ We are conscious of the fact that tener is not an auxiliary verb in Spanish as have is in English. There are two main reasons for the treatment it receives in this section: it is the direct translation of the English counterpart, and have and tener display similar syntactic behaviour. When substituting the complement by a pronoun, as in example (i), the accusative los appears. One tends to think that the accusative Case is assigned by the verb tener. Nevertheless, when turning the sentence into the passive voice the result is ungrammatical, as in example (ii). This could be explained in that, in this case, accusative is not assigned by the verb tener, but by Loc.

- (i) esta ciudad los tiene [this city them has]
 (ii) *son tenidos [___ are had]

Therefore, even though a more formalized analysis is needed, not only semantic but also syntactic similarities can be drawn between tener and have. As already mentioned by Bello (1988), haber [have] in Spanish still maintains its original meaning of tener ([have, possession]), as exemplified in sentences such as the ones in (iii):

- (iii) hubo fiestas [there-was parties]
 la ciudad tuvo fiestas [the city had parties]
 hay animales maravillosos [there-is animals marvelous]
 la naturaleza tiene animales maravillosos [nature has animals marvelous]

See subsequent sections for partitive Case in these constructions.

²⁹⁰ For Hoekstra and Mulder (1990), there in existential constructions is, in fact, a preposed locative.

²⁹¹ In a continuous discourse there is a strong tendency to start sentences with old information, i.e. with something already known, and to introduce new information towards the end of the sentence. In most existential sentences, locatives are definite and subjects are, by definition, indefinite. Therefore, the natural word order is locative before subject (Kuno 1971).

According to this analysis, in existential constructions where the locative occupies a subject-like position and the indefinite NP an object-like position, the locative must precede the NP.²⁹² When analyzing the examples in (69), (the basic word order being that shown in (69a)), (69b) comes from a locative-postponing rule which moves locatives to sentence-final position. As in any movement, it leaves a trace in its original position which in this case takes the form of there.²⁹³

- (69) a. on the table are two books²⁹⁴
 b. there are two books on the table
 c. on the table, there are two books

Locatives, postponed by the locative-postponing rule, can be placed in the sentence-initial position by the adverb-preposing rule, as in (69c), in which there is retained.

For those there sentences that lack locatives, Kuno's (1971) solution is a dummy item locative with no semantic content, which is what Pollock (1989) proposes with the predicate Loc.

²⁹² Notice that in the case of Spanish, this order is disrupted when applied to constructions with clitics. This is probably due to the compact form of there constructions in Spanish as opposed to French. For instance:

- | | | | | |
|-----|-------------------|---------------------------|------------------|-------------------------------|
| (i) | hay libros | (locative-expletive + NP) | los hay | (clitic + locative/expletive) |
| | [there-are books] | | [them there-are] | |
| | il y a des livres | (locative + NP) | il y en a | (locative + clitic) |

²⁹³ Kuno's (1971) analysis explains why there and not it, or any other grammatical formative, appears sentence-initially: the postponed locative leaves its copy in the original position in the form of the locative pronoun there, just as the postponed sentential complement leaves its copy in the form of the pronoun it.

²⁹⁴ Kuno (1971) explains the ungrammaticality in (i) by saying that non existential sentences such as (ii) do not have locatives in the sentence initial position. Instead, they have subjects, their structure being NP + be + locative, so that locative-postposing does not apply to them:

- (i) *there are the two books on the table
 (ii) the two books are on the table

When analyzing examples such as the ones in (70), two paraphrases are possible, as in (71):

(70) there is an engine in the car

(71) a. the car has an engine

b. in the car is an engine

The ambiguity of the sentence in (70) lies in the two possible relationships that can be established between the associate an engine and the locative complement in the car. These types of constructions are termed spatial by Muromatsu (1997) and standard interpretation constructions by Hornstein, Rosen and Uriagereka (1994). Of note is how the location or standard reading (71b) is paraphrased with the existential verb to be, while the integral one makes use of to have. The engine in (71a) is an integral part of the car and, therefore, the relationship expressed is an integral one. In the case of (71b), there is a spatial relation since the example indicates where the engine is located.

The connection which exists between location and the auxiliaries have/tener/avoir is taken a step further with the proposal of a universal locative paradigm (Freeze 1992). Under this paradigm the sentences in (72), to which we have added the Spanish examples, receive a similar explanation:

(72) predicate locative: the book is on the table
el libro está encima del banco

existential: there is a book on the bench
pro hay un libro encima del banco

have: Miguel has a book
Miguel tiene un libro

Both predicate locative, existential and possessive-have constructions are analyzed as derived, through different movement operations, from a single abstract syntactic structure.²⁹⁵ The thematic arguments of location and theme are shared by the three constructions; in fact, they essentially contain the same constituents although they display them in a different order.²⁹⁶

In some languages, instead of a constituent order alteration to differentiate between the three constructions, it is rather the presence of a proform in the existential that marks the difference (Freeze 1992). This is the case of English and Spanish/French, with the proforms there and -y/y respectively.

Movement operations are also to be divided: given the argument's theme and location, if the theme moves to [Spec IP], a predicate locative structure is created, whereas if the locative phrase moves to [Spec IP], an existential one appears.

In the languages dealt with here, the co-occurrence in existentials of a proform with a locative constituent elsewhere in the sentence also indicates a difference from the predicate locative construction. The proform existential, as Freeze (1992) terms it, involves the presence of a lexical locative (-)y in Spanish/French and there in English. His analysis, a comprehensive theory of

²⁹⁵ Which Freeze's (1992) understand to be a PP.

²⁹⁶ Longa, Lorenzo and Rigau (1998), based on Benveniste's (1966) analysis, propose that have and be in locative sentences are different spell-outs for the same abstract verb. See also Freeze (1992), Kayne (1993) and Hale and Keyser (1993). Campos (1997) also mentions that ser/haber in existential constructions in Spanish may be analyzed as containing the same underlying verb. For a crosslinguistic treatment along these lines, see also Freeze (1992), who claims that the distribution of have and be in Germanic and Romance is atypical since many languages have a single copula form throughout the locative paradigm. Kayne (1993) proposes that "have, both as a main verb expressing possession and as an auxiliary verb, is, in fact, a reflex of the incorporation of an abstract D/P head into be" (135). A recent proposal by Kempchinsky (1996), formulated within Chomsky's (1993) MP, claims that "have is be plus an abstract P, where this P may differ from language to language in its Case-assigning properties. When the incorporated P carries a structural Case feature, auxiliary have is morphologically identical to possessive have, while when the incorporated P carries an inherent Case feature, auxiliary have is identical to existential have" (136).

locative expressions in UG, is therefore a least effort analysis in the best tradition of the theory.

3.3.2. Lexical Doublets

Occasionally a double/dual possibility is presented, as shown in (73), so that either raising or expletive insertion can occur; the latter case -expletive insertion- can be either overt (as in English, French, and Spanish) or covert (as in Spanish). These cases present semantic doublets, as in the case of Loc in previous section:

(73)	a.	hay dos hombres sentados en el jardín	expletive insertion, overt
		<i>pro</i> están dos hombres sentados en el jardín	expletive insertion, covert ²⁹⁷
		dos hombres están sentados en el jardín	raising
	b.	il y a deux hommes assis dans le jardin	expletive insertion, overt
		deux hommes sont assis dans le jardin	raising
	c.	there are two men seated in the garden	expletive insertion, overt
		two men are seated in the garden	raising

Nevertheless, the examples in (73) are not synonymous since, in the expletive-insertion sentences, the associate is endowed with a non-specific reading, while the sentences in which the expletive undergoes raising also allow a specific

²⁹⁷ Due to the type of cliticization in Spanish lexical existential constructions (hay), when these are replaced by their corresponding empty form (*pro*), the copular verb must appear, thus causing what we call a split of the features within the construction hay since only the expletive features are substituted by *pro*. As previously mentioned, Suñer (1982a) maintains the presence of Ø, arguing that *pro* can be referential but not pleonastic.

- (75) a. there just may not exist a solution (to this problem)
 b. there occurred a catastrophe (in that century)
 c. there still seem to remain some problems (in this regard)
- (76) a. there walked a man into the room
 b. there jumped a horse over the fence
 c. there flew a mig into my eye
- (77) a. *there walked a man with a dog
 b. *there jumped a horse right at the queen's arrival
 c. *there flew a mig at high speed

For unergative verbs, the presence of the locative argument is required. The main idea is that there is a preposed locative and its meaning is ultimately determined by an adjunct chain with some other predicate constituent, possibly a locative (Hoekstra and Mulder 1990). If there is no such adjunct chain, there can only take on its non-deictic meaning in combination with be, a combination that is then interpreted as exist.

they closed the store down

they moved the headquarters to Brooklyn

the store closed down

the headquarters moved to Brooklyn

The term ergative originally applied to languages like Basque in which the complement of a transitive verb and the subject of an intransitive verb are assigned the same Case. By extension, however, it has come to be used to denote verbs like break which occur in both structures, where the vase seems to play the same thematic role in both types of sentences, despite the fact that it serves as the complement of broke in one sentence and the subject of broke in the other (Radford 1997b). For more on this see Burzio (1986) and Laka (1993). Burzio (1986) was the first one to term verbs like llegar [arrive] ergatives.

3.3.3. Existential Constructions and the Full Interpretation Principle

The principle of full interpretation (FI) (Chomsky 1995) constitutes one of the principles of economy applicable to both representations and derivations, which are crucial to the MP.³⁰¹ The FI principle bans any superfluous symbols in representations and any superfluous steps in derivations. According to FI, the legitimacy of an element at LF derives from the fact that it receives an appropriate interpretation at that level. So that by FI, elements which do not receive an interpretation should be absent at LF. On the LF side, FI might rule out the presence of too many superfluous constituents in a structure, such as unbound variables or NPs without theta-roles. On the PF side, FI might reject representations that contain symbols which have no phonetic realization (Marantz 1995).

When analyzing the existential construction in (78) by focusing on the semantic representation of the sentence, the presence of there becomes problematic. Expletives do not contribute to the meaning of the sentence; therefore, it is not clear what role the expletive plays in the LF representation of the sentence.

(78) there arrived [_{NP} three more candidates]

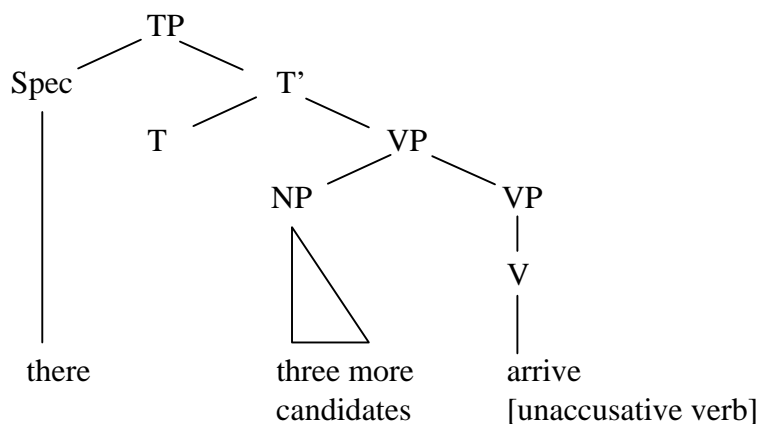

The first conflict surfaces when the FI principle is taken into account and applied to there constructions. Expletives, which are not arguments since they lack a theta-role, must be removed at LF: they do not receive any interpretation and therefore are not licensed as legitimate LF objects. One possibility may be to simply delete the expletive (Chomsky 1995). The result, however, would not be acceptable since it would go against the EPP: with the deletion of there, no subject would be present at LF. Consequently, there must be eliminated in order to conform to FI. Deletion, however, is not a possibility.

The phonological component exhibits special properties since there are true phonological features that are invisible only to the phonological component and form a separate subsystem (Chomsky 1998). This seems to be the case with expletives.

Two solutions have been proposed in order to solve this problem. The first focuses on the invisibility of there at LF and concentrates on syntax, (Chomsky 1991), or constitutes a semantic solution (Groat 1993). The second solution is based on the optimalist view of violable principles in a ranking system (Speas 1997).

Groat (1993) offers an alternative to the analysis proposed by Chomsky (1991). According to Groat (1993), expletives are in fact legitimate LF objects with an LF interpretation of null; therefore, there does have a semantic interpretation.³⁰² This proposal is based on the idea that LF does not see inside there because it completely ignores there. Therefore, although there can still be interpreted as an LF affix, it can also be said that it has a null interpretation at LF as a defective NP. The

³⁰¹ As we have seen, some of these principles include: procrastinate, last resort, greed and shortest link.

same analysis applies to Spanish existential *pro* since it is a null element both in terms of semantics (as there in English), and also in terms of syntax (Spanish being a null-subject language).

This apparent contradiction in the properties of the expletive may also be solved by opting for a more syntactic approach to the definition of there, an approach which has to do with its syntactic properties (Chomsky 1991). This approach focuses on the concept of there as an LF affix and on an analysis of there constructions based on movement. Along the lines of Groat (1993), Chomsky (1995) argues that, since there is a pure expletive, it is, therefore, invisible at LF to satisfy the FI principle.

Recent developments in optimalism also provide an explanation for the presence of these uninterpreted elements that violate the FI principle, and, at the same time, capture the differences between English and Spanish. Even if we accept the PP analysis that expletives delete immediately before the point at which they are semantically interpreted, they survive phonetically. Thus, the fact is that there are actually superfluous symbols in a representation when those symbols are necessary to fulfill some other grammatical principle (Speas 1997). An OT treatment of the subject is summarized in the ranking in (79):

- (79) English: SUBJECT >> FULL INTERPRETATION
 Spanish: FULL INTERPRETATION >> SUBJECT

The constraint SUBJECT, as termed by Grimshaw and Samek-Lodovici (1995), makes reference to the EPP that clauses must have a subject. Speas (1997)

³⁰² As will be seen, Groat's (1993) proposal of null interpretation offers an additional explanation for

redefines the EPP by adding that clauses must have a subject unless their predicates have no arguments and the language lacks overt expletives, which is in fact the case in Spanish. This is why in Spanish, FULL INTERPRETATION outranks SUBJECT. Again, a violation of principles actually takes place in order to satisfy higher constraints, which is accounted for in terms of OT.

3.4. Syntactic Properties

3.4.1. Agreement in Existential Constructions

In an attempt to capture verb agreement in expletive constructions among languages, the nominative agreement hypothesis (NAH) is proposed (Cardinaletti 1997).³⁰³ The NAH establishes that the verb agrees with the expletive if and only if the expletive morpheme is not ambiguous with an object morpheme. Given this generalization, the essential property is the nominative Case information on the expletive in subject position. Thus, il in French is used exclusively as a nominative form (the accusative form being le) and, therefore, it triggers agreement with the verb. We can add the case of Spanish to the French because of equivalent behavior, since *pro* cannot be used for objects. Italian, on the contrary, displays V-eNP agreement since the expletive morpheme may be used as both subject and object. In the case of locative elements such as there, since they do not display Case morphology, it is expected that, when used as expletives, they do not trigger agreement with the verb.³⁰⁴ The NAH has two main consequences for our analysis, as Cardinaletti (1997) also points out: on the one hand, and in line with the

the definiteness/indefiniteness of the NPs entering into there constructions. (See also Diesing 1992).
³⁰³ Chomsky (1998) argues that expletive subjects are found without T-associate agreement when there is no accessible nominative.

strongest current hypotheses about parameters, agreement properties are reduced to the lexical information contained in the expletive morpheme. On the other hand, it complies with minimalist feature movement and establishes a correlation between nominative Case and verbal agreement. She does not pursue the issue further, but this type of analysis will have bearing on the movement of the expletive. It also captures the different behavior between English and Spanish in expletive constructions.

Agreement in English constructions is carried out in the following way. Following the expletive's affixal analysis, since there lacks inherent phi-features (including Number); these features have to come from its associate. In this sense, the associate dictates these features for the entire amalgamated expletive (following Chomsky's notation). As a result, a singular associate, such as that in (80a) will ensure that the expletive has singular features, whereas a plural associate, as in (80b) will cause the expletive to take a plural form:

- (80) a. there is a man in the room
b. there are flowers in the garden

In that sense, in examples like that in (80b), we are dealing with plural agreement between the verb and a plural NP that is not overtly in subject position. In order to solve this contradiction of rules, Chomsky (1995) proposes that the expletive may be the target of a movement operation: the associate of the expletive moves to the position of the expletive in LF, thus combining the relevant features of the

³⁰⁴ Therefore, for Cardinaletti (1997) locative elements do not display Case features. This analysis contrasts the one proposed by Lasnik (1995, 1996) and Groat (1995), in which there bears nominative Case features.

expletive and its associate.³⁰⁵ This occurs whether the movement is expletive replacement or expletive adjunction.

It is by means of this association as well that the agreement between the expletive and its associate is to be explained, an agreement that is somehow unusual since it is an agreement to the right, as shown in example (80b).³⁰⁶ Even though -and precisely because- there must be replaced by a man/men, the features of the two elements cannot be different, so that, in the case in (81), both the expletive and the associate are marked with [+ singular]:

(81) [there, a man_i] is t_i in the room

For agreement purposes, arguments such as adjacency and directionality are not an issue, as the examples in (82) show (Schütze 1999):

- (82) a. there have always been cookies on the table
b. there often are too many people in this room
c. how many cookies are there on the table?

As (82a) and (82b) show, material can intervene between there and the plural verb. Also, as (82c) indicates, associate agreement arises in environments where the triggering NP is to the left of the verb.

Neither in the case of the verb nor in the case of the expletive there can lexical specificity apply:

³⁰⁵ This is what Chomsky (1995) calls amalgamated expletive.

³⁰⁶ As Chomsky (1998) explains, the subject (there) is visible but inactive, and unable to establish agreement with matrix T. See Groat (1997) for further complications on agreement relationships.

- (83) a. there appear/?appears to be cookies on the table
b. on the table are many cookies

As (83a) reveals, these constructions are not restricted to forms with the verb to be, and even the absence of there triggers plural agreement, as in the locative inversion construction in (83b).³⁰⁷

The explanation for these types of constructions in which a non-subject dictates plural agreement lies in the fact that this plural agreement generally arises when subject position contains an element that itself fails to trigger agreement (there in the case of expletive constructions (Bresnan 1994 and Schütze 1999)).³⁰⁸

The agreement analysis for Spanish/French and English will take different paths. In the first case, and as opposed to English there, it is not the expletive-locative element (-y/y) that is in subject position. This way, the relationship that is established between the locative and the NP does not dictate an agreement relationship with the subject.

Kato's (1999) analysis on the third Person agreement in Romance can also be extended to Spanish existential constructions.³⁰⁹ In a verb such as hablar [to speak], third Person singular Agr (habla) can be analyzed as belonging to the regular paradigm of verbal endings (-a being 3rdps), as Jaeggli and Safir (1989)

³⁰⁷ We will not deal with locative inversion here. For more see Deevy (1998) and Schütze (1999). These analyses include flat agreement and also a processing account to accommodate the analysis of agreement in this type of construction with the grammar of English. See also Bresnan (1994), Levin and Rappaport (1995) and Jang (1996). Analysis such as the one in Moro (1989) consider there constructions to be a particular case of locative inversion.

³⁰⁸ To this Schütze (1999) adds the pressure towards agreement between an inflected verb and the linearly closest NP which is attested in the human language-processing mechanism.

³⁰⁹ Alexiadou and Anagnostopoulou (1998) also go for the non-existence of an expletive *pro* in null-subject languages; they consider Agr an affix substituting *pro*. Nevertheless, they do not resolve the dichotomy of *pro*: one thing is to defend the necessity to eliminate *pro* and completely another to actually eliminate it, with the corresponding re-definition it entails regarding the theory built around this category.

defend, or as zero morpheme (\emptyset), that is, as null Agr as in Kato (1999). In fact, this type of agreement is the one that takes place in existential constructions in Spanish, using the same unmarked form for all discourse referents, whether singular or plural.³¹⁰

As far as agreement is concerned, the difference between the three languages under analysis is the following. English, which is a weak inflection language, cannot identify a category such as [+pronominal] Agr. Two consequences are derived from this: 1) the presence of there is obligatory and 2) overt agreement applies between the group expletive/eNP and the verb. On the contrary, as reflected in (84), both Spanish and French, which are strong inflection languages, present a covert 3rdps agreement. Both languages make use of their corresponding weak pronouns, Agr in Spanish and il in French.³¹¹

- | | | |
|------|---------------------------------|-----------------------------------|
| (84) | there is a man in the room | there are men in the room |
| | hay un hombre en la habitación | hay hombres en la habitación |
| | il y a un homme dans la chambre | il y a des hommes dans la chambre |

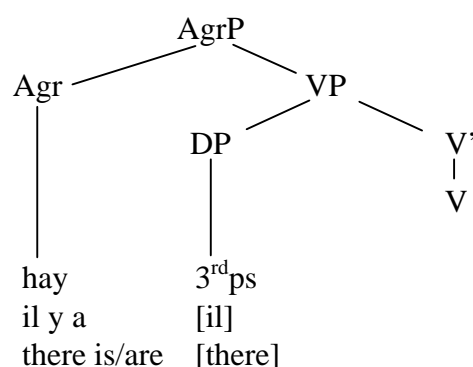

³¹⁰ Kato (1999) links this type of agreement to the agreement that operates in child grammars.

³¹¹ As mentioned before, French is a rich inflection language, like Spanish; it licenses the presence of Agr, but cannot identify it since the richness of inflection in French verbs is phonetically neutralized. See, Hoekstra, Hyams and Becker (1996), among others.

All languages have agreement, this being a universal property. Depending on the language, Agr can be an affix to Verb-Tense (as Kato 1999 defends for English), triggering an explicit agreement due to the [-strong] nature of I; or Agr can consist of elements that are independent of verbs (as Kato 1999 defends for null-subject languages such as Spanish), producing an implicit agreement thanks to the [+strong] feature in I.

Nevertheless, agreement in expletive constructions is not as straightforward an issue as it may seem. The examples illustrated in (85) point towards a different approach to agreement in this type of structures:

- | | | |
|------|--------------------------------------|------------------------------------|
| (85) | a. ?habían perros por la calle | había perros por la calle |
| | b. ?there´s three people in the room | there are three people in the room |
| | c. ?il est arrivé trois femmes | il sont arrivé trois femmes |

It is also necessary to account for cases of apparent mismatches in the agreement between the verb and the associate in the case of English and French, as well as cases of mismatches in Spanish; the latter ones seem to work opposite to English in that V-associate plural agreement is, at the least, odd in Spanish, as in (85a).³¹²

Therefore, when dealing with agreement in expletive constructions, two main issues have to be addressed: 1) whether other possible structures can be found, other than the normal/prestigious ones; and 2) the relationship between normal/prestigious forms and deviant/non-prestigious forms.

³¹² As previously stated, subjects in Spanish *hay* constructions can be analyzed as \emptyset (Suñer 1982a and Kato 1999, among others) or as a pleonastic *pro*. Whether we are dealing with pleonastic *pro* or \emptyset is a pending issue in the literature.

From the previous groups of examples in (84) and (85), we can say that different agreement patterns can be found both in English and in Spanish/French: subject-verb agreement and verb-associate agreement. What does differentiate these languages is what pattern constitutes the prestigious/non-prestigious form and how these are derived. The table (IX) presents the different alternatives that we will analyze:

Table IX: agreement patterns and prestigious/non-prestigious forms			
EXAMPLES	PATTERNS	LANGUAGES	STATUS
there are two men	V-eNP agreement	English	prestigious
there's two men	SV agreement	English	non-prestigious
<i>pro</i> hay dos hombres	SV agreement	Spanish	prestigious
<i>pro</i> habían dos hombres	V-eNP agreement	Spanish	non-prestigious

The nature of the element in subject position (there, *pro*) will be the focus when analyzing these constructions, specifically in terms of its relation with the eNP and how agreement is triggered by it.

As we will see in subsequent sections, one of the foremost consequences of the Case assignment hypothesis for there constructions is that it provides an account for cases such as those in (85) above, in which there is a clear lack of agreement. If Case is assigned to the internal argument (the associate of there, the eNP), and the chain between there and the NP is no longer created, then agreement will coindex only with the NP in subject position, that is, with the pleonastic element. As an immediate consequence, then, the verb will no longer agree with

the postverbal NP. The lack of agreement is crucially linked with the fact that the NP can get Case independently of the subject position (Travis 1984).

Thus, in the three examples in (85) above for English and French, the verb is singular (there's, est arrivé), and therefore does not agree with the corresponding NPs (three people, trois femmes). But according to the analysis outlined above, this surface mismatch does not reveal any ungrammaticality. It only reflects the fact that the agreement is between the pleonastic element in subject position (there, il) and the verb (is, est arrivé), since the subject and the postverbal NP are assigned Case independently and are not connected in any other way.

As Pollock (1982, 1989) has pointed out, it should be noted that this analysis affects copular verb to be, an analysis that is formalized to a greater degree by Belletti's (1988) theory of inherent Case and her proposal that be and other unaccusatives license Case.³¹³

The effects on agreement of the Case assignment hypothesis and the chain-relation analysis is explained in the following way (Travis 1984). If the verb agrees only with the NP in subject position, that is, the pleonastic, it is because I is coindexed only with this position; the pleonastic, in turn, is coindexed only with I. This means that either 1) there will always be assigned Case through coindexation, and there is no need to say that there can have inherent Case; or 2) if there is an NP which appears to be the logical subject, it is assigned Case by some element within the VP. This may either be the V itself or a preposition. T-type pleonastic appears in constructions both with and without agreement with this logical subject, which

³¹³ We will not pursue the question of Case here. At this point, we provide the necessary background for the analysis of agreement as double coindexation. Case properties and movement will be dealt with in subsequent sections.

means that the T-type pleonastic may or may not be in a chain. Its purpose is simply to spell-out Case.

When dealing with these cases of post-verbal NPs, Agr must be coindexed with an NP which is [+/- number] and [+ nominative] (Pollock 1982, 1989). Thus, an attempt is made to capture the differences which exist between English and French. The corresponding examples are shown in (86):

- (86) a. there are/??is three people in the room
 there is/*are a cat in the room
 ... then there comes/*come into the room an enormous dog
 ... then there come/*comes into the room three enormous dogs
- b. il y a/*ont trois personnes dans la chambre
 il y a/*ont un chat dans la chambre
 il est/*sont arrivé trois femmes
 il est/*sont arrivé une femme

Some of the assumptions in Pollock's (1982) analysis already deal with the types of verbs that are present in the constructions under analysis: French unaccusatives and English copulas. These are especially relevant to the present work since they are directly linked to Lasnik's (1995) and Belletti's (1988) proposals. French unaccusatives assign Case to the NPs, which they govern in the VP. At the same time, English copulas assign Case to the NP within the VP.

In this sense, in order to account for cases such as those in (87), the possible existence of two indexations in there constructions is defended (Pollock 1982, 1989):

- (87) a. ?? there's three people in the room
 b. there are three people in the room

In (87a) Agr is coindexed with there. As a consequence, an NP governed by Agr may be assigned the feature [- number], that is, singular. In (87b), in contrast, Agr is coindexed with the nominative NP inside the VP, which is marked [+ plural].

The two possible indexations in there constructions are exemplified as table (X) reflects:³¹⁴

Table X: Pollock's (1982, 1989) and Travis' (1984) double indexation	
	<u>there</u> Agr be <u>three people</u> in the room
(a)	
(b)	

The difference between the languages under analysis will be a question of different hierarchies of syntactic preference, depending on the parameters under which each language operates. English favors the type of agreement in (b) because it is a [-strong] (Pollock 1989) and [-pronominal] (Kato 1999) language; Spanish and French follow the pattern in (a) thanks to their [+strong] and [+pronominal] features.

The double indexation may offer an explanation for sentences that, while not conforming to the general pattern, cannot be considered fully ungrammatical in a categorical way.³¹⁵ It also complies with the minimalist assumption that Agr may have two specifiers.

³¹⁴ Sánchez-Lefebvre (2000) explains the Agr/lack of Agr possibility in terms of D-feature/phi-feature movements respectively. These are viewed, therefore, as two independent movements.

³¹⁵ In keeping with Pollock's (1989) and Travis' (1984) double indexation, Cardinaletti (1997) refers to the overt-expletive hypothesis (OEH). She tries to capture additionally the different type of expletive used: if there is an overt expletive (il in French), agreement takes place between the

Within the MP, new proposals have tried to account for the way agreement operates in existential constructions, both across languages (English and Spanish in our case) and with languages (prestigious/non-prestigious forms). Based on previous work by Travis (1984), Pollock (1982, 1989) and Belletti (1988), approaches like those of Campos (1997), Sobin (1997) and Schütze (1999) consider agreement properties and especially 3rd_p agreement as the key point. The question arises whether SV agreement really is SV agreement or rather 3rd_{ps} default agreement (null agreement in Kato 1999).

Agreement in Spanish/French seems to work differently (Campos 1997, among others). In both languages, verbs agree with their subjects in Number and Person; nevertheless, there is no agreement between verb and associate (considered to be the logical subject) in expletive constructions:

- (88) hay un hombre en la habitación
 hay tres hombres en la habitación
 il y a un homme dans la chambre
 il y a trois hommes dans la chambre

In principle, Spanish there constructions present a crystallized expletive form since the form for singular or plural verb-associate agreement is the same, as in (88). However, a residual case in some varieties of Spanish displays an overt verb-

expletive and the verb; if there is a non-overt expletive (*pro* in Spanish), agreement involves the verb and the associate. Locative-expletives (there) are excluded from the OEH since the verb may not agree with there in spite of its overtness. Cardinaletti rejects this hypothesis in favour of the nominative agreement hypothesis, which does not dissociate nominal and locative expletives.

associate agreement in the past tense (*pretérito imperfecto*, había/habían) [there-was/there-were], as shown in examples (89):³¹⁶

- (89) a. había un perro en el jardín
 [there-was a dog in the garden]
 b. ?habían perros por la calle
 [there-were dogs in the street]

The relationship between S and eNP is claimed to be affected by the locative element there/-y. Thus, the lack of agreement between the logical subject (the eNP) and the verb in (88) is attributed to the fact that the locative element somehow blocks the transmission of features from the eNP to the element in subject position (Campos 1997). In this case, the expletive receives the default features [3rdps].³¹⁷

³¹⁶ As mentioned in Torrego (1983), in Puerto Rican Spanish, the haber construction we have analyzed coexists with that shown in (i), where the postverbal NP shows Number and Person agreement with the verb:

- (i) habían muchos turistas en la ciudad [there-were many tourists in the city]
 Also hayn is used in Argentina, Colombia and Venezuela (Fernández Soriano and Táboas Baylín, 1999). For some authors (Medicoetxea 1999), this type of agreement is produced when haber is not used as an impersonal verb; in these cases, its direct object (the postverbal NP) functions as subject, establishing the same agreement as in periphrastic constructions, as in (ii) and (iii) respectively:

- (ii) habían demasiados problemas [there-were too many problems]
 (iii) siguen habiendo problemas [there-are still being problems]

³¹⁷ Rigau (1991) and Campos (1997) correlate the appearance of the clitic -y with a lack of agreement between hay and the associate NP in examples such as those in (i) as opposed to those in (ii):

- (i) hay un estudiante en la sala [there-is a student in the room]
 hay muchos estudiantes en la sala [there-is many students in the room]
 (ii) hubo/hubieron muchos incidentes anoche [there-was/were many incidents last night]
 habrá/habrán muchos problemas si continúa la huelga
 [there-will-be-singular/plural many problems if the strike continues]

In non-present forms, since the clitic -y is not present, Campos (1997) argues that academic and formal Spanish as regulated by the Spanish Royal Academy employs the non-agreeing form (perhaps by parallelism with the forms with hay); most dialects, however, employ the agreeing form.

Therefore, cases of mismatches (plural associate and singular agreement) are not grammar-contrary. A way of incorporating these constructions is to allow for the existence of both there blocking agreement altogether (default 3rdps agreement operating) and there failing to participate in agreement at all (leaving I free to agree with some other element, the associate NP).

Campos (1997) does not include the different status of SV agreement and V-eNP agreement in English and Spanish in his analysis. What is interesting about this proposal is that there's in English and hay in Spanish are both considered to have 3rdps default agreement.³¹⁸

In another attempt to capture the problematic nature of agreement in expletive constructions and assuming the MP, the so-called virus theory is proposed (Sobin 1997).³¹⁹ This analysis attempts to capture the different status of expletive constructions in terms of their agreement relations. Thus, expletive constructions such as those in (90) are the product of grammar external rules called grammatical viruses:

- | | | |
|------|---------------------------------------|------------------------|
| (90) | there are books on the table | plural NP associate |
| | there are a cat and a dog in the yard | conjoined NP associate |

³¹⁸ Campos' (1997) default agreement is also linked to Kato's (1999) proposal of \emptyset in existential constructions, as we will see.

³¹⁹ First outlined in Sobin (1994), virus theory is a theory of editing or monitoring toward prestige forms. The particular rules that facilitate such editing toward prestige constructions are called grammatical viruses. A grammatical virus is a device that can read grammatical structure and affect it, though it is grammar external. A virus is parasitic on grammar and facilitates the construction of prestige forms. A virus is detectable only against the background of a theory of grammar; it operates out of conformity with the principles that govern the proper devices of grammar. Viruses must be severely limited; otherwise, they would obviate the normal grammar. Therefore, any virus must fall within the bounds of a virus theory, a set of limitations on what constitutes a possible virus. Otherwise, virus becomes merely a label for unexplained phenomena and the empirical character of the grammatical theory is eroded.

The examples in (90) reflect plural agreement in expletives. This type of agreement involving prestige language is considered deviant.³²⁰ In contrast, the examples in (91) with singular agreement -which are normal nonprestige language- are considered normal local Spec-head agreement.

- (91) there's books on the table
there's/there is a cat and a dog in the yard

Thus, as opposed to previous analyses, Sobin (1997) proposes that plural agreement is theory-contrary and, in that sense, Spanish singular agreement is seen as the normal, most universal behavior (default).³²¹ The analysis of the data shows that examples like (90), explained in terms of covert specifier agreement (the associate NP undergoes covert movement to [Spec AgrS], there being an LF affix affixing to the associate NP), do not reflect how agreement in expletive constructions works. Rather, they are to be derived via grammatical virus rules.³²²

It is more costly to check features with a grammar-external device (a virus) than to check them via the regular devices of grammar. Therefore, the more economical derivation of a singular construction would always involve Spec-head agreement with the expletive there, leaving the virus to check plural agreement only. Within the grammar proper, a derivation is blocked when it is more costly (less economical) compared with another derivation of the same construction. In

³²⁰ Transmission of agreement from associate to subject (Chomsky 1986, 1993, Burzio 1986, among others) is rejected here. Default agreement to account for cases like (85) is also abandoned.

³²¹ This is the case of both Spanish and French. As Freeze (1992) argues, the case of English may rather be an exception.

³²² As Sobin (1997) maintains, though viruses are external to the grammar, they are nonetheless "natural" and can be "smoothed in" so that the output can sound natural or acceptable to a native speaker. However, unlike grammatical principles, viruses must be explicitly learned in connection with particular vocabulary because, in their natural form, they are lexically specific.

the case of viruses, the prestige constructions that viruses allow in (90) have a virtually identical normal derivation in (91). So in this sense, prestige constructions are nonoptimal. In addition, although this nonoptimal characteristic is not sufficient to block these constructions, they are marked: they are less economical to employ and hence are not consistently employed.³²³

Under a minimalist perspective, Sobin's (1997) proposal raises some questions: if SV agreement is less costly, being an internal device, why does a language (e.g. English) not favor it?; also, if V-eNP agreement is more costly, why is this option in fact the preferred one in a language (e.g. English)? These two issues are problematic in that they violate economy principles. Nevertheless, it is interesting to note that although structures are possible in both languages, the status attributed to each of the structures is, as Sobin (1997) points out, language-specific.

Sobin's (1997) analysis coincides, as well, with Chomsky's (1995) interpretation of there's structures as a frozen option, a superficial phenomenon in which the agreement with the associate is overridden, as in examples (92a) and (92b):³²⁴

- (92) a. there's three books on the table
b. there's a dog and cat in the room

It cannot therefore be extended to constructions such as those in (93):³²⁵

³²³ For more on the antioptimality principle for prestige constructions, see Sobin (1997).

³²⁴ This was previously pointed out by Morgan (1972), Milsark (1974) and Gazdar and Pullum (1980); and by Runner (1989) and Aissen and Runner (1989) for some varieties of Spanish.

³²⁵ Notice that this type of structure makes use of the contracted form there's instead of the full form there is.

- (93) *is there three books ...?
 *there isn't any books
 there are / *is, I think, some strange people here

Also, only the clitic copula seems to be possible, as in (91a) *versus* the ungrammaticality of (94b) and (94c) (Cardinaletti 1997):

- (94) a. there's three men in the room
 b. *there is three men in the room
 c. *there was three men in the room.

Since a virus approach poses some problems, we should consider that agreement default in cases of singular agreement (there is + plural NP) result in constructions that are generated by the grammar proper (Schütze 1999).³²⁶

Cases of singular agreement such as those in (95) may be seen as a failure of the verb to agree with the associate and, therefore, as a marginal if not totally ungrammatical option:

- (95) there's two things I want you to consider

Nevertheless, a reanalysis of such a statement is required based on the evidence of the examples listed in (96):

³²⁶ Schütze (1999) deals with cases of plural agreement, flat agreement and singular agreement. We concentrate on singular and plural agreement. Flat agreement refers to constructions with a conjoined associate, e.g.:

- (i) there's (is/are) a book and a pen on the desk
 (ii) there ('s/is) are some books and a pen on the desk

- | | | |
|------|--|--------------------------|
| (96) | a. there's often problems at the South Precint | no strict adjacency |
| | b. how many calories' there (/izθr/) in a Tic Tac? | no rightward application |
| | 's there (/zθr/) any cookies in the cupboard | no rightward application |
| | c. here's the books you ordered | absence of <u>there</u> |
| | where's your books? | absence of <u>there</u> |

As in the case of plural agreement, strict adjacency (96a), rightward application (96b) and presence of there (96c) cannot strictly ban these constructions. For some speakers, as analyzed by Smallwood (1997, 1998), this non-agreement is not even restricted to frozen forms containing 's.³²⁷ Thus, an unaccented reading of was with reduced vowel is acceptable in contexts like (97):

- (97) there /w z/ 50 people at the party last night
- (98) on the top of the line there is three stick people³²⁸

Furthermore, examples such as (98) were attested in Smallwood's (1997, 1998) data when non-agreeing existential constructions occurred without contraction.³²⁹ Also, as we have previously seen in the case of Spanish and French and as examples in (99) show, the grammaticality of singular agreement with a plural postverbal NP is possible in other languages:

For more see Morgan (1972), Milsark (1974), Gazdar and Pullum (1980) and Sobin (1997).

³²⁷ A similar analysis is carried out in Meechan and Foley (1994) in interview transcripts of Canadian-English speakers.

³²⁸ Notice that the deaccented forms can also be used to express true 3rdps agreement with an NP subject. In contrast, full forms are only possible in real 3rdps agreement.

³²⁹ It is interesting to note that singular agreement is also evidenced in locative inversion:

- (i) on the centre of the page is two houses
in the bottom is three stars

(99)	il y a deux hommes dans l'auto	*il y ont deux hommes ...
	<i>pro</i> había dos hombres en el coche	* <i>pro</i> habían dos hombre ...
	[there-was two men in the car]	[there-were two men ...]

Schütze (1999), along the lines of Campos (1997) and partially following Sobin (1997), argues for an analysis in which singular 3rdp I is a default form.³³⁰

There may trigger 3rdps agreement which, in the case of a plural NP associate as in (95), will imply non-agreement.³³¹ This type of agreement cannot be understood as I agreeing with there, since I cannot enter into any agreement relationship with this type of subject (Smallwood 1997, 1998 and Schütze 1999). It should be viewed rather as a default form, that is, I is 3rdps by default. V-eNP agreement is, therefore, a genuine syntactic option and, as such, is subject to certain restrictions. Schütze (1999) points out two cases in which non-agreement is not available in existential constructions: in constructions where it is not possible to contract be and in presentational there constructions.³³²

Summing up, the existence of default agreement (there's + plural eNP in English and hay + plural eNP in Spanish) and of non-subject agreement (there are + plural eNP in English and habían + plural eNP in Spanish) is then attested in both languages. Default agreement arises when there and -y block agreement. Non-subject agreement is the result of agreement between the verb and the logical

Smallwood's (1997, 1998) data additionally confirm that both agreement and non-agreement with plural associates are used by the same person in different tasks involving different degrees of formality.

³³⁰ Schütze (1999) also explains singular agreement in terms of temporary ambiguity: if we assume that there is a general tendency toward local agreement, we can specifically claim that at the point of encountering the verb in (97) or (99), the parser is guaranteed to have heard/read the entire subject, and, thus, singular agreement with there/pro takes place.

³³¹ Meechan and Foley (1994) provide a different treatment of non-agreement.

³³² Notice that when the subject is an NP, I obligatorily agrees with it. Agreement with the subject is not possible when the subject is not an NP and one of the two situations described above arises.

subject, the eNP, because the grammatical subject, there/pro, fails to participate in agreement at all.

The question of the status of both options in English and in Spanish, as we have said, is what brings about differences between them. Sobin's (1997) proposal of prestige/non-prestige language can be adapted to optimalistic terms where principles can be violated if it is to satisfy a higher constraint. The prestige/non-prestige dichotomy should not be seen as grammatical/ungrammatical, since both are legitimate options, but rather as distinguishing between the options a language favors. Combining both Sobin's (1997) and Schütze's (1999) proposals, it is also true that the grammaticality and acceptance of such mismatches (singular forms in English and plural forms in Spanish) is not uniform, but rather is restricted to certain contexts and varieties within each language.³³³

The hierarchical orders of constraints for each language are the ones in (100):

(100a) English:

SUBJECT >> NON-SUBJECT AGREEMENT >> ECONOMY >> DEFAULT AGREEMENT

(100b) Spanish:

SUBJECT >> ECONOMY >> DEFAULT AGREEMENT >> NON-SUBJECT AGREEMENT

Both languages must comply with the EPP (SUBJECT) either with there or with *pro/∅*, and since this constraint is ranked higher, it cannot be violated.³³⁴ The

³³³ For the alternance of Agr/lack of Agr in existential constructions see Cardinaletti (1997) for English, Campos (1997) for Spanish and Dubois and Lagane (1989) for French, among others; also, for Spanish, Bello (1988), Cuervo (1939), Henríquez Ureña (1940), Gili Gaya (1943), Fernández Ramírez (1951), Kany (1969), Seco (1988), Alcina and Blecua (1975), Roca Pons (1976), Montes Giraldo (1982) and Suñer (1982a, 1982b, 1988) for an analysis of the NP as an O_d; Luque Moreno (1978) and García Yebra (1983), for an approach to the NP as a subject.

³³⁴ See the previous section for the different ranking between SUBJECT and FULL INTERPRETATION in English and Spanish.

economy principle of procrastination and the degree to which it can be violated will differentiate the order of constraints. If ranked higher, as in Spanish, this principle will make default agreement the first option; if ranked lower, as in English, eNP, the logical subject is higher in the hierarchy. Although both agreements are allowed, non-prestige forms are always ranked lower, default agreement for English and non-subject agreement for Spanish.

3.4.2. Movement in Existential Constructions: Case and Economy Principles

Agreement relations are linked in a special way to Case assignment properties in existential constructions, as we mentioned in the previous section. We will now concentrate on the movement which takes place within these structures, a movement that, within the MP, is directly related to Case and economy principles.

Within existential constructions, there are two elements eligible to receive Case: the subject element (locative there and expletive *pro*) and the existential NP (eNP). The question is whether these Cases are assigned independently (so that the subject may or may not have Case) or whether the Case of the eNP is licensed via its association with the subject element (so that the subject must have Case).

The different proposals regarding the Case of expletives polarize then in two main directions: Case transmission (from the expletive to the eNP) and inherent Case (expletive and eNP are not related in terms of Case). What all proposals have in common is that expletives are subject to the Case filter.³³⁵ We will deal with them separately and see whether the different behavior of English and Spanish existential constructions may be explained in terms of different

³³⁵ Case filter is the requirement that every argument be assigned abstract Case. Following Chomsky (1981), *NP, if NP has phonetic content and has no Case.

proposals which will accommodate the general properties of each language concerning Case.

3.4.2.1. Expletive Constructions as a Manifestation of Case Assignment

The analysis of existential constructions is thus first seen in terms of the so-called Case transmission analysis (also referred to, with slight changes, as substitution analysis, chain analysis and expletive replacement approach). This analysis is mainly focused in English and it poses some problems not only in its application to Spanish but also to English itself. Nevertheless, we will explore this analysis and the consequences it has for both English and Spanish expletive constructions since it does set the basis for the study of this type of constructions based on Case properties.

T-type pleonastics cannot be assigned theta-roles since they lack the feature [+ Person].³³⁶ At the same time, these pleonastics are related to Case assignment (Travis 1984). These two characteristics then define the type of position in which T-type pleonastics occur: it has to be a non-theta-role position and also a Case-marked position. According to the EPP, the type of position can be restricted even further if one considers that non-theta-role positions will always be subject positions. Therefore T-type pleonastics are defined as elements which appear in

³³⁶ As mentioned in previous chapters, Hoekstra and Hyams (1996) differentiate between languages depending on the specification of I. If I distinguishes between the different grammatical Persons, then it is [+Person] (as in Spanish); if, on the contrary, it differentiates between singular and plural, it is marked for Number (as in English). In the case of pleonastic elements, Spanish shows a different behavior: while English is still marked for Number, Spanish is marked for neither Person nor Number.

Chomsky (1999) defends that nominals and expletives too must have the features [Person] since they rise, and pure expletives of the *there*-type should have no other formal features. In a framework that dispenses with categorial features, as is reasonable on minimalist grounds, [Person] plays the role formerly assigned to [D] or [N] features. We will see Kato's (1999) analysis which attests to this theory.

some structural position, as subject NPs, and whose near complementary distribution will be determined by the theta-assigning abilities of the VP.³³⁷

In example (101), while the NP a great treasure receives theta-role in the object position of the verb discover, the pleonastic element there which cannot bear a theta-role is assigned nominative Case accordingly by Agr:

- (101) there was discovered under the tree a great treasure
a great treasure was discovered under the tree

Therefore, both elements, the referential a great treasure and the pleonastic there, are in a complementary distribution. In fact, this type of complementary distribution can cause both elements to merge, and therefore create one single element by means of a movement of the referential element to the subject position, which will then have both Case and theta-role assigned. It is by confronting these types of examples that T-type pleonastics simply become a manifestation of Case assignment, and perhaps even a late spell-out rule of the feature [+ Case] (Travis 1984).

The basic idea within the Case transmission analysis (Chomsky 1980, 1986, among others) is that both the expletive and its associate need Case.³³⁸ But, due to the Case requirement of the associate, which is not satisfied in its original position, a relation of association is established between the expletive and the associate so

³³⁷ Williams (1984) claims that there is an NP that can occupy only NP positions. Being also a scope marker, it cannot occupy positions to which theta roles are assigned. Consequently, there occupies only the NP position of a subject.

Expletives appear only in subject positions because it is in these positions that they are assigned Case and because the subject position is the only one to which no theta-role is assigned since the complement has no semantic role. Nevertheless, in subject position the expletive can bear nominative Case, as in (i), or accusative Case, as in (ii):

(i) I believe [there is a man here]
(ii) I believe [there to be a man here]

³³⁸ See Tremblay's (1997) analysis of expletives that favors Case transmission in English but not in French. Her analysis also provides arguments against the claim that be is a Case assigner.

that the Case requirement of the latter is satisfied via its association with there, as in (102):

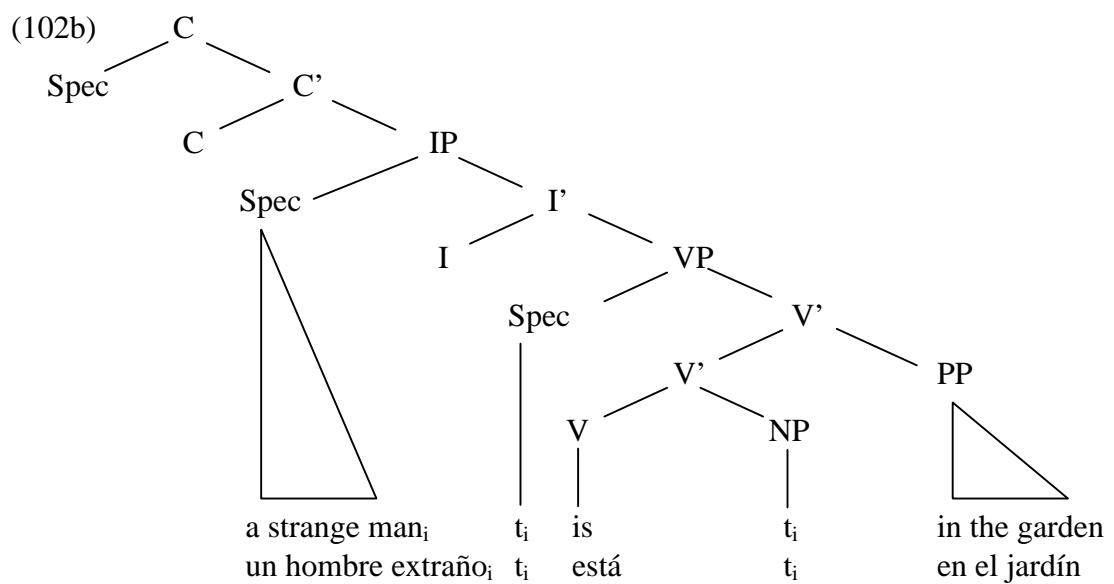
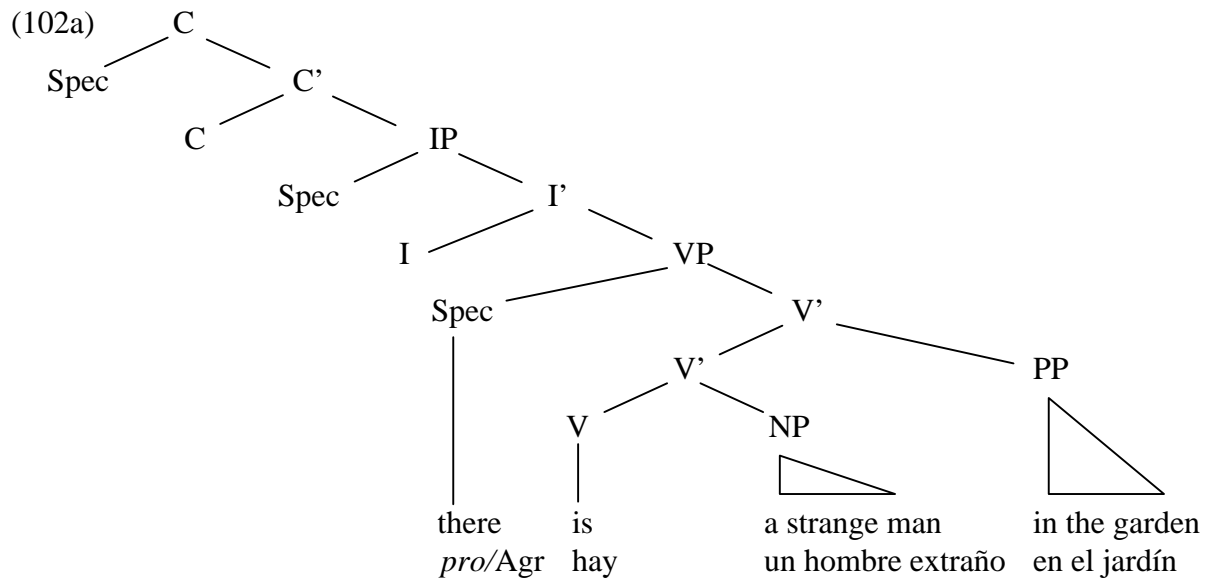

As a result, a chain-like property for such a relation appears. This association is achieved through substitution by means of which there is replaced by its associate

in LF, as indicated in (102a) before the substitution and in (102b) after it has taken place.³³⁹

3.4.2.2. Case Transmission and Accusative Case: Be versus Haber

The only element receiving Case is then the subject since the verb to be is not considered a Case assigner (Safir 1982, Torrego 1983 and Tremblay 1997). This decision in the analysis of existential constructions will immediately differentiate the behavior of these constructions in English and in Spanish: chain formation in the former for the eNP to get Case and direct assignment of Case by the verb in the latter.

In the case of English and assuming that be is not a Case assigner, the postverbal NP receives Case through a chain relation with the expletive there. Agreement gives nominative Case to there and, therefore, Case transmission operates. As the examples in (103) reveal, this expletive/eNP relation also entails agreement between V_{exist} and the associate a book / three books:

(103) there is a book

there are three books

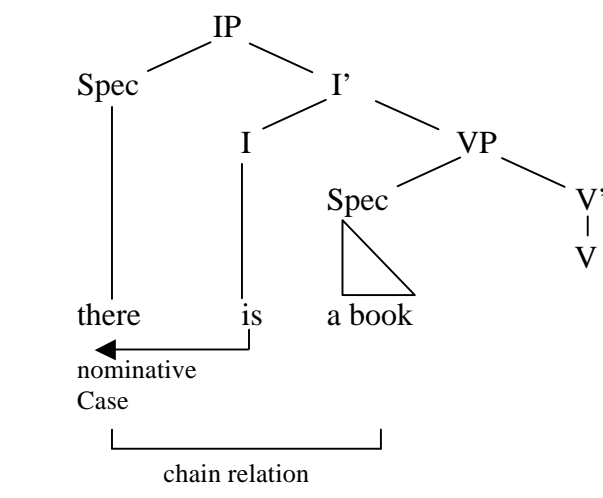

³³⁹ Notice as well that, in the case of Spanish, a change of verb is needed (from haber to estar).

Furthermore, as Hoekstra and Mulder (1990) point out, if we accommodate these constructions to the VP-internal subject hypothesis, and assume that nominative Case is always assigned to [Spec IP], it follows that nominative Case must be used either to license an argument or an appropriate dummy:³⁴⁰

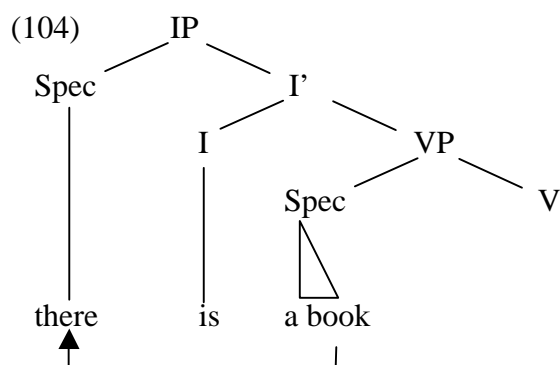

[Spec IP] is not a position where a thematic role can be assigned (Chomsky 1981).

But, since Case is assigned to it, [Spec IP] is regarded as an A-position.

In both Spanish and French, the verbal head used in existential constructions is not be but have (haber and avoir, respectively). This difference will bring about the Case distinction between have and be existential constructions.³⁴¹ Haber and avoir, like have, are transitive verbs and, as such, can assign accusative Case to the associate NP.³⁴² As opposed to English, therefore, there is no

³⁴⁰ The assumption here is that Case and phi-features of a noun are part of its internal constitution, either intrinsic to it or added optionally as N is selected from the lexicon for the numeration.

³⁴¹ As mentioned before, evidence of this is seen in Old French.

³⁴² See also Hoekstra and Mulder (1990). Evidence of the accusative Case is seen when the postverbal NP is a pronoun/proform (Torrego 1983):

- (i) ¿hay estaciones de metro en esta zona de la ciudad?
 [is-there metro stations in this part of the city?]
 - no **las** hay en esta zona, pero las hay muy cerca
 [not them there-is in this part, but them there-is very near]
 *¿hay **ellas** en el área?
 [is-there they in this part?]

Nevertheless, in spite of this accusative Case, these types of sentences cannot be passivized:

- (ii) hay varias ardillas en el jardín [there-is several squirrels in the garden]
 *fueron habidas varias ardillas en el jardín [there-were-been several squirrels in the garden]

coindexation between the NP and the subject. Consequently, no Case transmission operates and no agreement is shown between V_{exist} and the associate, as the examples in (105) demonstrate:

- (105) *pro* hay un libro / tres libros
 il y a un livre / trois livres

The subject in French, like in English, absorbs nominative Case; but Spanish *pro* lacks Case properties.³⁴³ The different analyses for English and Spanish explain also agreement properties in these languages as the table (XI) shows:

Table XI: Case and agreement properties	
English	Spanish
Case transmission Agr between verb and associate	no Case transmission no Agr between verb and associate
Case of <u>there</u> : Agr (nominative)	Case of <i>pro</i> : \emptyset
Case of the eNP: chain (nominative)	Case of the eNP: verb <u>haber</u> (accusative)

As we mentioned before, the substitution analysis has to be abandoned since it poses several problems. For one, English there has specific features that cannot be deleted due to the condition on recoverability of deletion. Furthermore, the substitution analysis causes some difficulties for the application of binding

Torrego (1983) links this feature to the thematic role of the *pro* subject in these constructions: the null element in subject position in Spanish carries the thematic role of quasi-argument. As we will see later, this may be explained in terms of partitive rather than accusative Case (Belletti 1988).

³⁴³ Pollock's (1981) analysis shows that il cannot transmit Case.

conditions.³⁴⁴ Also if the subject element is the one having Case, a problem arises in the case of the Spanish null element (either *pro* or null agreement). Therefore, we will need to account for the Case assignment phenomenon in expletive constructions under a more unified perspective, since arguing a chain analysis for English but not for Spanish confronts minimalist maxims and is clearly not satisfactory.

3.4.2.3. Inherent Case Assignment and Unaccusatives

From this point and if the chain analysis is to be rejected in light of an inherent Case assignment analysis, the next problem that needs to be solved is which element will assign Case to the eNP, both in the case of English and Spanish.

There are other proposals, which are based on Belletti (1988), that do consider be as a Case assigner of a special kind. Within this perspective, the analysis of expletive constructions will include movement properties and principles of economy.³⁴⁵

Belletti's (1987, 1988) proposal has its origins in the unaccusative hypothesis (Perlmutter 1978 and Burzio 1986) according to which verbs of this

Notice that for Suñer (1982a, 1982b), impersonal sentences with haber do not have a syntactic-semantic subject.

³⁴⁴ See Lasnik and Saito (1991). See also Lasnik (1996) for an analysis arguing that Case transmission does not exist. Bošković's (1994) and Lasnik's (1995) analyses reveal that these problems are not entirely solved in the affixation analysis (Chomsky 1991, 1993).

Hornstein (1994) also points out that under a minimalist approach, an expletive replacement analysis of there constructions is ruled out.

Moro (1989, 1990) and Hoekstra and Mulder (1990) provide an analysis on minimalist terms of the there-raising analysis of expletive constructions.

For there insertion analyses see Emonds (1970), Milsark (1977) and Williams (1984).

³⁴⁵ Lasnik (1995, 1996) is the first to formally defend the position that both expletive and associate must have Case, even though their corresponding Cases are independently licensed. Lasnik's (1996) analysis goes so far as to say that Case transmission does not even exist.

class do not assign the characteristic Case of objects (namely, accusative) to their object. As we said before, Belletti maintains that only the capacity of these verbs to assign accusative Case is suspended but not their capacity to assign partitive Case.³⁴⁶

Adopting Chomsky's (1986) theory of syntactic Case, partitive Case is considered an inherent Case. According to this theory, two kinds of syntactic Case are distinguished (structural and inherent) as reflected in table (XII):

Table XII: inherent Case <i>versus</i> structural Case	
<p>INHERENT CASE</p> <ul style="list-style-type: none"> - it is assigned at DS - it is assigned by a lexical head to the NP it governs - Case licensor must assign a theta-role to the Case licensee 	<p>STRUCTURAL CASE³⁴⁷</p> <ul style="list-style-type: none"> - it is assigned at SS - it is checked in LF in [Spec AgrO] - there is no theta-marking requirement

Belletti (1987), based on an analysis of certain facts in Finnish, defends that the inherent Case assigned by unaccusative verbs is partitive. Therefore, there are two different Cases associated with V: partitive, which is inherent and not subject

See Travis (1996) for an approach to Case adjacency. While agreeing with Lasnik on the obligatory presence of *be*, she assumes predicate NPs do not require Case since adjacency facts fall outside of the domain of Case theory.

³⁴⁶ Perlmutter's (1978) terminology makes reference to unaccusatives and Burzio's (1986) to ergatives. Intransitive verbs are divided into two syntactic types: 1) unergatives which typically have agentive subjects (*to play, to dance ...*); and 2) unaccusatives or ergatives which have non-agentive subjects, subjects that denote the person/thing affected by the eventuality indicated by the verb. Both types of verbs coincide in that they only require one argument (the external one, the subject), but they differ in the semantic relationship that is established between this argument and the verb (Mendicoetxea 1999).

³⁴⁷ There are two types of structural Case: nominative and accusative. Nominative Case is assigned by I/Agr to the NP in subject position. Accusative Case is assigned by V to the NP in object position. See Woolford (1997) for a distinction between two structural Cases for objects. Objective Case is assigned/checked in [Spec AgrO] and associated with object agreement; accusative Case is assigned/checked by V inside VP and never associated with object agreement. While only one objective Case per clause is allowed, more than one structural accusative Case per clause is permitted.

to Burzio's generalization, and accusative, which is structural and subject to Burzio's generalization.³⁴⁸

Therefore, there are two ways in which a Case bearing category can discharge its Case feature: inherently, which involves no pronominal category, no Agr head, and which directly assigns the Case feature in the projection of the Case assigner; and structurally, which involves adjunction to a pronominal head (Agr) and the assignment of the Case feature to the specifier of that head's projection. That is, inherent and structural Cases result from the possible intervention of a pronominal element in Case assignment (Laka 1993).

In our analysis, unaccusative verbs inherently assign partitive Case, a property they share with accusative verbs (where partitive Case assignment combines with accusative Case assignment).

The most relevant difference between unaccusatives and accusatives is the theta-marking requirement, since, while working within the MP, the difference between DS and SS is no longer applicable, and the configurational difference, as Lasnik (1995) analyzes, tends to disappear.³⁴⁹

It is also important to stress here that partitive Case always selects an indefinite meaning for the NP that carries it, which is equivalent in meaning to that of a lexical quantifier like some. Furthermore, the fact that unaccusatives are

³⁴⁸ Burzio's generalization has two properties: 1) a verb which lacks an external argument fails to assign accusative Case; and 2) a verb which fails to assign accusative Case fails to theta-mark an external argument.

For Belletti (1988), partitive Case is not subject to Burzio's generalization because it is assigned in environments where accusative Case is not available, as in (i) and (ii):

- (i) there are unicorns in the garden
- (ii) hay unicornios en el jardín

³⁴⁹ This theta-marking requirement will have important consequences on the light verb analysis (a light verb is a verb that has no theta-role of its own to assign).

For Lasnik (1995), there has structural Case (Chomsky 1998). Also Lasnik (1995) and Epstein and Seely (1999) take the Case of the associate to be determined *in situ* along the lines of Belletti (1988), an inherent Case, perhaps partitive, but in any event independent of agreement and distinct

inherent Case assigners provides then a straightforward reason for the existence of the definiteness effect (DE) in many languages, as we have already mentioned.³⁵⁰

The main idea is that only indefinite NPs are compatible with partitive Case, this being the only Case unaccusative verbs can assign to their objects.

So following this account on partitive Case, we can argue that the examples in (106) reflect this type of Case, not only in French but also in Spanish:

(106)	hay libros	los hay	*ellos hay
	il y a des livres	il y en a	
	[there-is books]	[them there-is]	[they there-is]

In French there is a clear distinction between partitive and accusative forms of pronouns, so that it presents two different sets: en as the partitive pronoun, and le, la, etc. as part of the paradigm of accusative pronouns. Thus, in the French examples in (106), the clearly partitive pronoun en appears. The case of Spanish is different since no such dichotomy of forms is present. The confluence of accusative and partitive forms in the Spanish paradigm provides no distinction of such Cases. It is quite revealing that the substitution of libros by the nominative pronoun ellos is ungrammatical, while the substitution by the so-called accusative pronoun los is

from nominative/accusative. For Chomsky (1999), the associate has structural Case with the value of accusative.

³⁵⁰ Belletti presumes that this is so in all languages. In addition, Freeze (1992), in his crosslinguistic analysis, states that it is unlikely that any language allows for the existential to have a definite theme.

The indefiniteness of the postverbal NP is what makes the sentences comply with binding conditions (Safir 1982, Torrego 1983). Otherwise, the NP should be free and not linked to an element dominating it (see principle C in the binding theory: according to Haegeman (1994) and Haegeman and Guéron (1999), R-expressions must not be bound by NPs in A-positions).

Abbott (1997) links the type of postverbal NP in there sentences to the different functions served by there sentences. Based on previous work by Prince (1992) and Ward and Birner (1995), she mentions the following: making the addressee aware of the existence (or absence) of entities,

the grammatically correct option. The deduction here is that, following Case marking in French and other languages, one can also talk about the assignment of partitive Case in this type of Spanish construction.

The way in which Case is assigned in English is explained along the same lines since existential be in (107) assigns Case to the eNP (among others, Lasnik 1996 and Travis 1996):

(107) there is a man here

To sum up, Belletti (1988) defends the existence of a parameter that allows unaccusative and passive verbs to assign Case of some sort to their internal arguments, which she argues is partitive Case. If the internal argument (the existential NP) is assigned Case, there is no need for it to form a chain with the element in subject position. Accordingly, the element in subject position may have its own Case as the referential NP does. Under such circumstances, no chain will be possible since the result will be a chain with two Cases, thus creating a violation of Case theory.³⁵¹

As regards the Case of the element in subject position, we defend that both there and *pro* display no Case properties. The subject element in Spanish is a null element (either *pro* or null agreement) and so it has no Case. Also, following

introducing new entities into the discourse, drawing the addressee's attention to their presence (or absence), or simply acknowledging the existence of certain entities.

³⁵¹ As Lasnik (1996) points out, Belletti's (1988) partitive Case proposal also provides the basis for an answer to scope in existential constructions in examples such as those in (i):

- (i) someone is likely to be here
there is likely to be someone here
there is someone likely to be here

For more see Safir (1982, 1987a, 1987b), Williams (1984) and Barss and Lasnik (forthcoming).

Cardinaletti (1997), locative elements do not display Case features and so there, being a locative expletive, does not bear nominative Case.

As opposed to the Case transmission analysis where there receives nominative Case from Agr/I and the question of *pro* is left unanswered, a common solution is provided here by focusing on the different nature of the subject elements in English (locative) and in Spanish (null).

3.4.2.4. The Motivation for the Movement: Economy Principles

In expletive constructions and even if no Case transmission operates, it is true that there exists a relationship between the elements in subject position and the eNPs. This type of relationship is analyzed in terms of movement.

Within the minimalist framework, movement must conform to two main conditions: 1) it must be driven by morphological requirements and 2) there must be a driving force for such movement. In the case of expletive constructions, this last assumption is what leads to propose that the driving force for the movement of the eNP to the subject position is either greed (Chomsky 1993, Bošković 1995) or enlightened self-interest (Lasnik 1995).³⁵²

So in order to account for the principle of economy which rules the movement in this type of constructions and under the last resort condition on movement, we will first consider whether movement conforms to greed.³⁵³ Within the MP and according to the economy principle of greed, items move only to

³⁵² Chomsky's (1993) approach is a Case transmission one while both Bošković's (1995) and Lasnik's (1995) consider be a partitive Case assigner.

In the case of expletive constructions, Chomsky (1998) terms this phenomenon suicidal greed in that it is greed with the further requirement that the matched probe deletes.

³⁵³ According to the last resort condition, "derivations are driven by the narrow mechanical requirement of feature checking only, and not by a 'search of intelligibility' or the like" (Chomsky 1993, 33).

satisfy their own requirements. Nevertheless, if we consider be as a partitive Case assigner, an adjustment has to be made to reconcile greed with the NP Case-marked by be prior to the LF adjunction to the expletive. We can consider that instead of the associate raising to adjoin to there, there lowers and adjoins to the associate (Bošković 1995).³⁵⁴ The affix hopping analysis of there constructions is licensed, according to Bošković (1995), since one is dealing with expletives which, while being semantically empty, do not affect theta-role assignment.

Nevertheless and under a minimalist framework lowering operations are not allowed. So this version of greed is not a satisfactory principle under an inherent Case approach. The other option is to consider a more relaxed type of greed where items move to satisfy either their own requirements or those of the position they move to. This new principle is referred to as enlightened self-interest (Lasnik 1995).

Under this proposal, we take the expletive's affixal property as a starting point, something that Chomsky (1991, 1993) has already pointed out. Once it is assumed that the movement of the associate is not driven by its own Case requirements, a reason for the movement of the associate is required. The stranded affix constraint (Lasnik 1981) offers a possible solution. According to this constraint "underlying freestanding affixes have to ultimately be attached to an appropriate host" (Lasnik 1995, 619). So, in an example such as (108), the LF affix there/pro_{expl} is attached to an NP that bears partitive Case (a man/un hombre):

- (108) there is a man in the garden
pro_{expl} hay un hombre en el jardín

³⁵⁴ See Bošković (1995) for a detailed analysis. Through the analysis of verbs of the believe-class, together with their infinitival complements, passive forms and nominalization, Bošković (1995)

In order for the derivation not to crash at LF, a man/un hombre has to adjoin to the affix (there, *pro_{expl}*), thus satisfying the requirements of the affix. A man/un hombre, with its own inherent partitive Case, gains no individual benefit from moving to subject position. The movement benefits only the target element, there/pro_{expl} itself. Greed is then too strong a constraint, and it should be relaxed to enlightened self-interest in order to include not only the requirements of the moved element, but also those of the position to which it is moved.³⁵⁵

The two basic proposals outlined above concentrate on three main issues: 1) the nature of the subject element itself as an LF affix; 2) the properties assigned to V regarding Case assignment; and 3) the close relationship that is established between the subject element and the eNP in terms of a movement operation of some kind. In this third point and under Kayne's antisymmetry, this movement cannot be a movement to the right, as Bošković (1995) postulates. Assuming that the expletive and the eNP get Case independently (Belletti 1988), no Case requirements of the eNP can trigger the movement of the eNP to subject position, as Chomsky (1995) claims. Therefore, the principle that rules the movement between the expletive and the eNP is triggered by the properties of the expletive itself as an affix. Since there/pro is an LF affix this movement is always covert.

3.5. Representations of Existential Constructions

In keeping with the minimalist perspective, the operations involved in the process of constructing a sentence include *select*, *project*, *merge/agree* and *move*.

arrives at the conclusion that the movement is in accordance with greed, since greed is the only one that rules out A-movement from Case-checking to non-Case-checking positions.

³⁵⁵ Cardinaletti's (1997) view parallels Lasnik's (1995) in that the movement has to do with the affixal weak properties of the expletive. Lasnik explains it in terms of the stranded affixal constraint

In the examples in (109), the verbs is/hay/a are selected from the lexicon already fully inflected and, while being heads, they project according to X-bar structure, as in (110):³⁵⁶

(109) there is a car in the garage

hay un coche en el garaje

il y a une voiture dans le garage

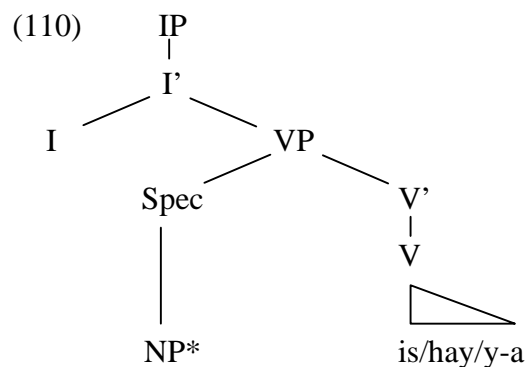

The items a car/un coche/une voiture are then merged with the previous items in order to fill the slots created by the projection, also in (110). The expletive elements there/il are to be located in [Spec IP], not through *move* but through *merge*, something that is limited to expletives (in a normal expletive construction,

and Cardinaletti focuses on the movement of weak elements. See also Cardinaletti and Starke (1994) for a typology of weak elements.

³⁵⁶ The organization of the tree diagrams complies with the minimalist theory (Chomsky 1995, 1998, 1999). The position of Spanish preverbal subjects as adjuncts to IP has not been followed here to make the explanation clearer and concentrate on how the different operations in existential constructions take place in each language. The trees in (i) and (ii) illustrate the case of Spanish *versus* English:

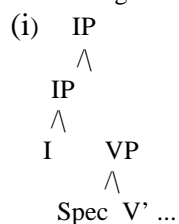

Agr hay una casa

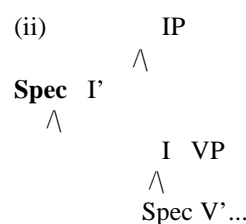

there is a house

the strong D-feature of T is satisfied by an expletive rather than by the raised subject) (Chomsky 1995).³⁵⁷

Since it lacks overt expletives, subject position in Spanish will be occupied by the pronominal agreement (following Kato 1999), third Person default Agr or \emptyset Agr, as in (111):

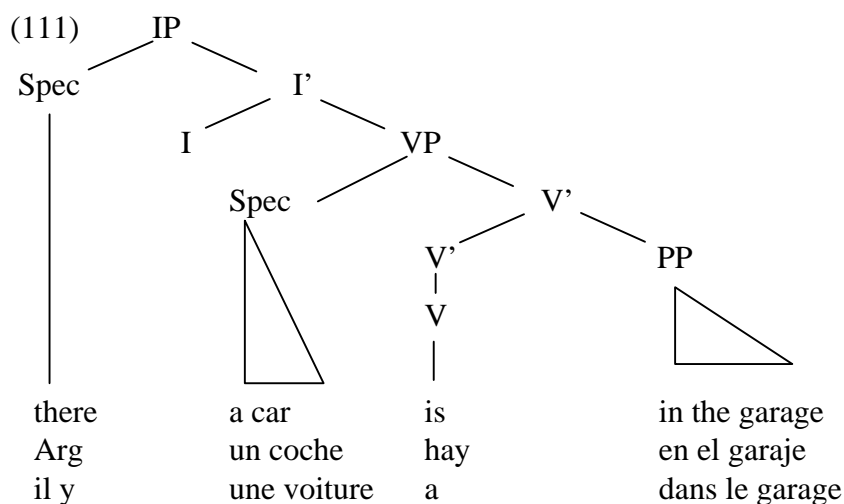

The *agree/move* operations involved affect the verbal head (is/hay/a) and also the NPs. Regarding verbal heads, and following Pollock's (1989) [+/- strong] I, English verb will undergo feature movement out of VP into IP, but in the case of auxiliary verbs such as be, as in (112):

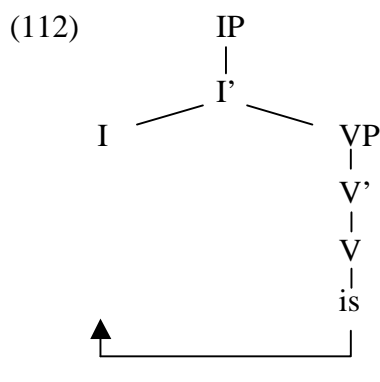

³⁵⁷ Bobaljik and Jonas (1996), in their analysis of a group of Germanic languages, propose a [Spec TP] parameter. They suggest that the specifier of a VP-internal functional projection (tense phrase) may host subject NPs under certain conditions. Although their analysis of transitive expletive constructions (which are excluded both in English and in Spanish) is not included in our analysis,

Spanish/French being [+strong] allow for all verbs, including hay/a, to raise to IP. The analysis proposed in (113) locates hay/a in V and then raises it through *move* to I.³⁵⁸

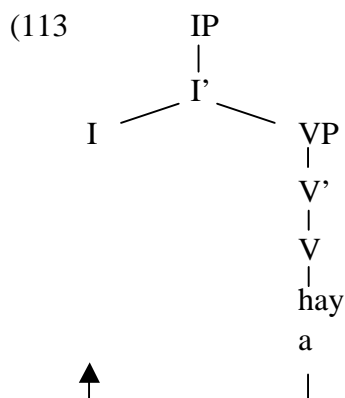

In this way, and because of the nature of the verbs involved in these constructions, the three languages present the same overt operation (English lexical verbs would, otherwise, undergo covert movement and would thus be different from Spanish/French).

The NPs in [Spec VP] remain *in situ* in existential constructions but they undergo feature movement to check their features and, in the case of English, trigger in this way associate-V agreement (via the association of the NP to there).³⁵⁹

In the case of there, the associate moves covertly to [Spec IP] in order to satisfy the affixal properties contained in the expletive element in subject position, in this way complying with the enlightened self-interest principle (Lasnik 1995). The same analysis applies to Spanish and French constructions but we have to bear

they do consider [Spec TP] as a subject position of some kind. The S-structure availability of [Spec TP] may be subject to parametric variation.

³⁵⁸ The [Person] feature of IP reduces to third Person (the default choice) when it attracts the expletive to [Spec IP]. See Sigurdsson (1996) and Chomsky (1998).

in mind that the affixal expletive/locative features in these languages are contained in the verbal heads themselves which are located in IP.

The complete tree with *merge* and *move* operations for the three languages is as in (114) below:

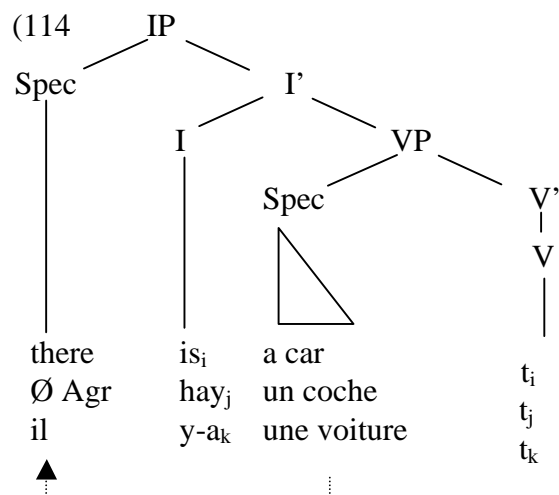

Therefore, differences between English and Spanish will also appear when *agree* operation applies, as the tree diagram in (115) reflects. The matching of features triggering agreement takes place, as usual, between [Spec IP] and [I]. In the case of Spanish, the element in [Spec IP] has third Person singular agreement (default Agr or Ø Agr), and when the verb moves to I, these are the features that are checked. Therefore, irrespective of the Number of the NP in [Spec VP] (the associate), agreement will always be third Person singular. The same analysis applies to French, though the corresponding weak pronoun is not [+pronominal] Agr but il.

³⁵⁹ As Chomsky (1995) interprets, this can be considered residue of the earlier adjunction-to-

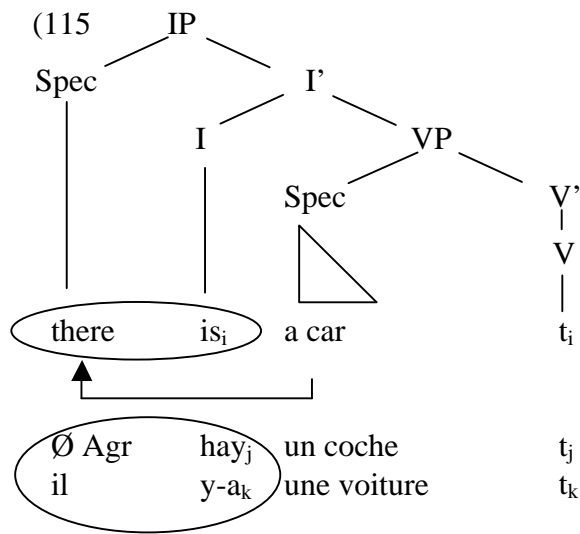

In the case of English, the element in [Spec IP] is also the one matching features with the one in I. But in this case, the features of the element in [Spec IP] mirror the ones of the postverbal NP (a car), so that if the NP is singular, there will have [+singular] features. When the verb undergoes feature movement to I, it will confront its features to the ones of there (which are in fact the ones it inherits from its association with the NP).

Therefore, even though a more formalized analysis is needed, it can be said that in the case of Spanish, one is dealing not with different lexical forms, but rather with different features within the same form: English and Spanish share those features; what they do not share is the way the different features are framed in the syntax.

3.6. Conclusion

In this analysis of expletive constructions, we have tried to provide a description of pleonastic elements and, more specifically, of there and there

expletive analysis.

Apart from the element in subject position, these constructions contain as well an auxiliary verb (be/haber/avoir), a locative feature/predicate that is represented differently in each language and an existential indefinite NP.

Parts of the theoretical bases for the analysis predate the minimalist approach, but they have been reformulated within it. To conduct the analysis, an initial typology of expletive elements has been provided in order to determine the specific nature of there constructions. An overview of other constructions that may superficially parallel expletive structures has also been presented (presentational and ergative structures).

The semantic and syntactic properties of there constructions which have been discussed can be summarized as follows:

1. The proposals in this chapter are related in one way or another to the minimalist approach. They include not only minimalist analyses, together with optimalist perspectives, but also other proposals which constitute very interesting analyses and whose consequences and achievements can well be included and adapted within the MP. Phenomena such as movement and others related to it, such as the theta-criterion, the FI principle, Case theory, agreement properties and economy principles, are relevant to the analysis. More specifically and among other issues, we have dealt with the analysis of the locative element and the position it occupies in the different languages (Freeze 1992), the LF nature of the expletive (Chomsky 1991, 1993, among others), subject position and the EPP (Speas 1997), the analysis of the expletive/eNP relation in terms of different Case assignment mechanism (Travis 1984, Belletti 1988, Pollock 1989), the principle ruling the movement between expletive and eNP, not as a lowering mechanism (Bošković 1995), but rather as one that satisfies the properties of the expletive as an LF affix (Lasnik

1995, Cardinaletti 1997), and the agreement relationships in terms of default agreement and non-subject agreement (Sobin 1997, Schütze 1999).

2. In the analysis of expletive constructions, English, Spanish and French seem to present a series of similarities with regards to the EPP, Case assignment of the associate, the economy principles which affect the covert movement of the associate, and the presence of an either implied or lexically expressed locative meaning in such constructions.

3. Differences between the three languages involve the subject in the following respects: 1) the different nature of the subject itself (overt in English and French *versus* covert in Spanish) containing or not locative features; 2) the representation of the locative predicate in these constructions, either linked to the subject position (as in English) or not (as in Spanish/French); 3) the agreement relations established in each language and their status as prestigious forms (non-subject agreement in English and default agreement in Spanish) and non-prestigious forms (default agreement in English and non-subject agreement in Spanish); and 4) the Case assignment to the expletive subject and the indefinite NP. Differences in the distribution of verbal and locative-existential features may be seen as a gradation with regard to the syntactic visibility of those features in each language; thus, English presents both overt agreement and a split of verbal features (be) and locative-existential features (there); French presents no overt agreement but it does present the split of verbal features (a) and locative features (y); while Spanish lacks both overt agreement and the split of features, all features contained in the same item (hay).

Existential constructions have a series of characteristics that, far from being independent features, interact and create different types of interdependence

relationships. For instance, the fact that the locative element in English occupies the subject position will trigger a certain type of agreement relations in this language.

The analysis of expletive constructions is not conclusive. The main goal in this study is to explore what these constructions share in the different languages and what makes them different, that is, the specific properties that provide a detailed account and an accurate description of the behavior of each of the languages.

CONCLUSION

In this study, we have tried to show that recent developments in linguistic theory carried out within the PP model and the MP provide an excellent framework for the comparison of both very subtle and more general differences and similarities between languages. The analysis languages as close as English and Spanish benefits from proposals meticulous and exhaustive enough to compare structures that might otherwise be overlooked in other cases.

Furthermore, we have used said framework to analyze the subject and its position in the sentence in English and Spanish. With respect to subjects, English and Spanish differ in the following aspects: 1) the possibility of null subjects in Spanish as opposed to English; 2) the analysis that has been proposed in the case of preverbal subjects in Spanish (adjunction and left dislocation) as compared to English (movement from base-generated position); and 3) the possibility of postverbal subjects in Spanish as contrasted to English. Specifically, we have concentrated on the richness of inflection and on movement properties in order to provide a comparative account of word-order differences and similarities between English and Spanish in terms of the value of subjects and subject types in both

languages. We have shown that the [+/- pronominal] agreement differences are responsible for: 1) the placement of subjects, preverbal and postverbal positions in Spanish, and preverbal positions in English; 2) the possibility of lexical and empty subjects in Spanish and lexical subjects in English; and 3) the relationships established in existential constructions as structures containing the special type of subject element known as expletive.

We consider SVO order to be the basic universal word order. The point of departure when speaking of word order is Greenberg's (1963) universals with different word-order patterns (SVO, SOV, VOS ...). The word-order parameter and the directionality parameter also account in similar terms for the different position of elements in the sentence.

It is interesting to point out that, when dealing with word order, studies have usually concentrated on declarative sentences, which are considered unmarked with respect to interrogative or imperative sentences. Following this tradition, Hernanz and Brucart (1987), among others, adopt the division between marked and unmarked sentences for their study. In the case of marked sentences, SV inversion is practically obligatory; these include the different types of interrogative sentences (total, partial and echo) and imperative sentences. According to this tradition, SV inversion in the case of unmarked sentences is less systematic and is always triggered by the presence of certain factors.

A somehow similar view underlies recent work within the MP where the key idea is to explain in a unified way, as far as the syntactic apparatus used is concerned, the different position of subjects (SV/VS). In the new perspective, there is only one unmarked order, SVO, and a motivated movement of constituents which explains other arrangements that are not SVO. The canonical word order in

all languages including English and Spanish is then SVO, regardless of the type of sentence (declarative or interrogative).

Based on a universal SVO order and from the general characteristics marking the development from the PP model to the MP, we have tried to show how these can be directly applied to the specific analysis of subjects and their positions in English and Spanish. The following table summarizes the main characteristics of PP and MP.

Table 1: comparing PP and MP		
	PP	MP
levels of representation	principles apply to 4 levels to obtain a grammatical sentence in every language: DS, SS, PF and LF	grammaticality conditions apply only to PF and LF
checking of features	in a Spec-head or head-complement relation	only in a Spec-head relation
operations	movement	agreement and movement <i>agree</i> is preferred over <i>move</i>
variability among languages	in terms of parameters (each one has 2 options)	in terms of the +/- presence of [+strong] features

If compared to the previous PP model, in the MP the levels of representation are reduced to the two external interface levels with the performance system: logical form (LF) in the conceptual-intentional system and phonetic form (PF) in the acoustic-perceptual system. The internal interface levels, D-structure and S-structure, are dispensed with together with the problems they pose. In this framework, a derivation is driven by the conceptual necessity to satisfy the interface conditions, some of which can be subsumed under other general

conditions that have to do with economy and optimality. This is the case of subjects in expletive constructions where LF conditions are not met in English since the element in subject position has phonetic form (there) but no meaning. The presence of there is explained in terms of optimality theory. OT deals with the constraints that affect languages, and especially with how these constraints may not have the same status in the hierarchy of constraints in all languages. So, for example, both English and Spanish are subject to constraints such as the fact that all elements in the sentence must be interpretable from a semantic point of view, and the fact that all sentences must have a subject. In the case of expletive constructions, while in English the subject constraint outranks the interpretability constraint (and thus there appears), in Spanish interpretability is ranked higher and no lexical subject is present.

The minimalist checking of features only under a spec-head relation brings about antisymmetry and the question of Spanish preverbal subjects as adjuncts and English preverbal subjects as arguments. Antisymmetry captures word-order differences in terms of different hierarchical structures: if an element is located in a more external position than another element in the hierarchy of the sentence, this fact is reflected in the superficial arrangement of the sentence. Therefore, it is crucial to set the exact position of an element and distinguish between an element that, generated in a certain position, has moved to another position (as preverbal subjects in English), and an element that has been adjoined to a specific position (as preverbal subjects in Spanish). In fact, preverbal subjects in English, despite apparent similarity, are not equivalent to Spanish preverbal subjects. The behavior of each language with respect to this issue is related to the null subject parameter or pro-drop parameter.

The initial point is the presence of an independent agreement functional projection (Pollock 1989) and also the consideration of *pro* as a null element identified by a lexical agreement (Contreras 1991, among others). The lexical properties attributed to agreement turn it from a functional projection into an actual category, an argument of the verb with a [+/- pronominal] dimension (Kato 1999, among others). Such reformulation, while maintaining the pre-Minimalist order in a certain way, has an effect on the inner characteristics of constituents and on the way they are moved. A [+/- pronominal] agreement makes reference to the paradigm of subject weak pronouns that is at the heart of differences between English and Spanish in terms of subjects: English, with a [- pronominal] agreement, has an overt lexical pronominal system (I, you, ... sing) with the same status as lexical NPs (DPs); Spanish, being [+ pronominal], has verbal endings as the corresponding paradigm of weak pronouns (cant-o, canta-s, ...). In this sense variability between the two languages is located in the category agreement, that is, the language variability is morphologically based.

This analysis of rich verbal inflection implies a re-analysis of lexical preverbal subjects in Spanish. Since it is a strong inflection language, Spanish always exhibits a [+ pronominal] agreement, and the lexical preverbal subject is seen as an adjunct. It follows, therefore, that since agreement is a clitic and the lexical preverbal subject an NP (DP), the two are not in complementary distribution and that, in fact, in sentences containing a lexical preverbal subject, [+ pronominal] agreement is also present. The chain relation between the NP and agreement has a special status in the sense that the chain is not the product of movement. The chain relation ensures that there must be a matching of indexes between the NP and agreement, that is, that the mechanism of co-indexing has to operate.

The canonical position of the subject within the verbal phrase is reserved for the real argument in all cases. This adjunction of an NP (preverbal subject) is an operation that adds a new layer of structure in preverbal position: neutral phrase if the operation is unmarked and topic phrase or focus phrase if the subject is marked, focused or topicalized. NeutP for Spanish parallels [Spec IP] for English in the position preverbal subjects occupy; and while in Spanish constructions agreement is the real argument, in English it is the preverbal NP. The value of this analysis lies in its capacity to actually distinguish between preverbal subject structures in English and Spanish: even if both are SV sentences, the constructions are not equivalent.

The difference between agreement and movement operations is another minimalist characteristic that is relevant for our analysis of subjects, since it points towards a crucial fact: the difference between English and Spanish subjects in terms of [+/- pronominal] agreement triggers agreement relations for Spanish (a [+ pronominal] agreement language) and movement relations for English (a [- pronominal] agreement language).

Since MP includes the restriction on basic operations to *merge* and *agree* (the latter reducing to deletion of uninterpreted matched features), each preempting the more complex operation *move*, it follows that if *agree* is possible *move* should not take place. This explains both postverbal subjects and expletive subjects. Spanish postverbal subjects need not move out of the verb phrase since Spanish is a [+ pronominal] agreement language; subjects may therefore remain *in situ*, in [Spec VP] where all subjects are generated. In English, on the contrary, *move* is compulsory because it is a [- pronominal] agreement language: since *agree* is not possible, subjects never appear in postverbal position, but must move to [Spec IP].

Also, expletive constructions in Spanish reflect a [+ pronominal] agreement that will not require any movement operation. The type of agreement found in these constructions in Spanish is third person default agreement or null agreement. The movement analysis of expletives is, on the contrary, applicable in English, a covert movement in terms of a coindexation between subject there in preverbal position and the NP in postverbal position that triggers agreement. The constructions there is/are and hay contain a notion of location. It is interesting to see how this [+ Loc] feature is implemented in both constructions since it parallels the different weak pronominal systems in both languages: the presence of the locative predicate in English is overtly expressed through an independent lexical item (there) in subject postverbal position, moved from [Spec VP], the canonical position for subjects and required in English as a [- pronominal] agreement language. In Spanish, on the contrary, the form ha-y has the locative element -y enclitic in the verb following the also enclitic subject argument, [+ pronominal] agreement.

We started this research by approaching three main issues:

- how preverbal subjects are different in English and Spanish,
- why postverbal subjects are only possible in Spanish, and
- why agreement in expletive constructions works differently in the two languages.

These issues are given a common general answer that can be summarized as follows: agreement properties are different in English and Spanish, as English has [- pronominal] agreement and Spanish has [+ pronominal] agreement. As we have seen, the analysis of subjects in expletive constructions, for instance, is carried out both in OT terms with different hierarchies of constraints operating in each language and also attending to different operations involved (*agree* or *move*). Both

answers to the same question come to be unified under the [+/- pronominal] agreement analysis. This crucial difference is what brings out that each language sets its own requirements as to the different types of subjects allowed as well as to the operations involved.

The analysis of movement and its consequences for implicit and explicit word order has concentrated on the question of preverbal and postverbal subject constructions and on expletive constructions. In more specific terms, by making use of different parameters such as the opacity/transparency of AgrP (Pollock 1989), the *pro*-drop parameter (Perlmutter 1971, Taraldsen 1980, Rizzi 1986, Jaeggli and Safir 1989), Belletti's (1988) insight on unaccusatives, and Contreras' (1991) and Kato's (1999) analysis of agreement, we have tried to define the characteristics and the behavior of the two languages under analysis, pointing both at the universal properties as well as language-specific properties. The insight we have gained by applying this analysis is twofold: first, preverbal subjects in English and Spanish cannot be analyzed in the same way; second, it is the [+/- pronominal] dimension of agreement that is responsible both for the presence of postverbal subjects in Spanish but not in English, and for the different subject elements found in expletive constructions in both languages.

The way sentences are generated in the MP complies with cyclicity. Cyclicity is another restriction included within the MP that makes reference to the access to the features provided by UG: cyclicity establishes that this access is carried out in successive steps.³⁶⁰ At each stage in the derivation of a sentence, a subset of lexical items and features is extracted from the lexicon (LA_i), so that when this LA_i is exhausted, two options are available. The way this applies to

subjects is as follows: 1) the process of building up a sentence proceeds since all elements needed are present, as is the case of Spanish in null subject constructions and expletive constructions, since verbs come fully inflected from the lexicon and [+ pronominal] agreement comes enclitic on the verb; and 2) further information than the one contained in LA_i is required and a second subset, LA_j , has to be extracted first to proceed in the same way as in 1; this process operates in English preverbal constructions and expletive constructions where an independent lexical item (weak pronoun, lexical NP or expletive there) is extracted from the lexicon to be moved to inflection and function as a subject. Also, this second access to the lexicon is the one providing for the NP adjunct that appears in preverbal subject constructions in Spanish, an item that is merged via adjunction into inflection.

The importance attained by the lexicon ties in with the uniformity principle. The uniformity principle states that “in the absence of compelling evidence to the contrary, assume languages to be uniform with variety restricted to easily detectable properties of utterances” (Chomsky 1999, 2). This application of this principle diverges into two main directions: 1) basic inflectional properties are general though phonetically manifested in various ways (or not at all), (Vergnaud 1982, and others); and 2) parametric variation is restricted to the lexicon, and insofar as syntactic computation is concerned to a narrow category of morphological properties, primarily inflectional (Borer 1984, and others). We consider the lexicon to be the locus of variation between English and Spanish. In this sense, for instance, whether they remain *in situ* (as in English) or raise to T or C (as in Spanish) (Pollock 1989), verbs are not interpreted differently in English as compared with Spanish. In the same way, agreement as an argument is uniformly

³⁶⁰ As we have seen, this is the cyclic approach to accessing the lexicon, much in the manner of

present in both languages (specified as [+/- pronominal]). The change from an agreement projection to an agreement category has then two main consequences: the reduction of the technical apparatus which is at the heart of the MP, and the fact that language variation is morphologically based.

Several issues remain to be accounted for in a more detailed way. The minimalist account of subject positions still faces some problems such as the nature of the category *pro*, the accommodation of preverbal subjects in Spanish to a dislocated structure, and the minimalist idea of cyclicity and narrow syntax (Chomsky 1998, 1999). These questions and other related issues are of extreme interest for a future and more complete comparative analysis of word-order variation under minimalist assumptions. Whether we should dispense with the category *pro* altogether in favor of agreement is a pending issue. It may be that in some cases (e.g., expletives) this can be done, but if we are to extend it to all other cases of *pro*, all properties linked to *pro* and the pro-drop parameter will have to be re-defined. We believe this is possible and certainly desirable but needs to be looked into further. The equivalence of Spanish verbal endings ([+ pronominal] agreement) and English personal pronouns as both being weak pronominal systems is very appealing and challenging. Also, if preverbal subjects in Spanish are analyzed as dislocated structures, we need to research further on the relationship between dislocation and markedness. In the same way, cyclic access to the lexicon as part of the MP is still developing and requires further elaboration.

We are conscious of the fact that many of the topics included in this study need further analysis and elaboration. Nevertheless, we hope that we have pointed out the connections that may be established among several aspects of the theory,

distributed morphology (Halle and Marantz 1993).

and that we have been able to open the door for a comparative analysis that may limit the relationships between languages, while at the same time enriching our view of their specific differences and enhancing our knowledge of language.

The general tendency in generative grammar is to bring languages together and to discover common ground existing among them, without denying their individual special features in the process. What seems to be clear is that variation among languages is essentially morphological in character. Thus, in spite of the universal character of this theory and the fact that the model aims to be applied to all languages, the detailed and thorough analysis it provides as well as the central role now played by features (which are in a way the interface between morphology and syntax) makes possible the comparison of languages like English and Spanish. That is, this analysis accounts, on the one hand, for the differences underlying the apparent similarities, and, on the other, for the parallelism that can be established between structures that, in another way, and regarding only superficial distribution, may be considered different.

BIBLIOGRAPHY

- Abbott, B. 1992 Definiteness, existentials, and the 'list' interpretation. In C. Barker, and D. Dowty, eds., *Proceedings of SALT II*. Columbus: Ohio State University.
- Abbott, B. 1993 A pragmatic account of the definiteness effect in existential sentences. *Journal of pragmatics*. 19. 39-55.
- Abbott, B. 1997 Definiteness and existentials. *Language*. 73-1. 103-108.
- Abney, S. 1987 The English noun phrase in its sentential aspect. Doctoral dissertation, MIT.
- Adams, M. 1987 From old French to the theory of pro-drop. *Natural language and linguistic theory*. 5. 1-32.
- Aissen, J. 1975 Presentational-*there* insertion: a cyclic root transformation. *Papers from the eleventh regional meeting, Chicago linguistic society*. 1-14.
- Aissen, J., and J. Runner. 1989 Spanish left conjunct agreement. 64th meeting of the linguistic society of America, Washington, D.C.
- Alcina, J., and J.M. Blecua. 1975 *Gramática española*. Barcelona: Ariel.
- Alcoba, S. 1999 La flexión verbal. In I. Bosque, and V. Demonte, eds., *Gramática descriptiva de la lengua española*. Madrid: Espasa.
- Alexiadou, A., and E. Anagnostopoulou. 1996 Symmetries, asymmetries and the role of agreement. Ms., ZAS Berlin and University of Tilburg.
- Alexiadou, A., and E. Anagnostopoulou. 1998 Parametrizing AGR: word-order, V-movement and EPP checking. *Natural language and linguistic theory*. 16. 491-539.
- Alsina, A. 1999 Where's the mirror principle. *The linguistic review*. 16-1. 1-42.
- Archangeli, D. 1997 Optimality theory: an introduction to linguistics in the 1990's. In D. Archangeli, and D.T. Langendoen, eds., *Optimality theory: an overview*. Oxford, Mass.: Blackwell.

- Archangeli, D., and D.T. Langendoen, eds. 1997 *Optimality theory: an overview*. Oxford, Mass.: Blackwell.
- Ariyoshi, S. 1980 Definite nouns in *haber* sentences. *Lingüística hispánica*. 3. 41-69.
- Arnaiz, A. 1992 On word order in wh-questions in Spanish. In A. Kathol and J. Beckman, eds., *MIT working papers in linguistics*. 16. 1-10.
- Atkinson, M. 1992 *Children's syntax: an introduction to principles and parameters theory*. Oxford: Blackwell.
- Authier, J.M. 1992 Parametric account of V-governed arbitrary null arguments. *Natural language and linguistic theory*. 10. 345-374.
- Baker, M. 1985 The mirror principle and morphosyntactic explanation. *Linguistic inquiry*. 16. 373-416.
- Baker, M. 1988 *Incorporation: a theory of grammatical function changing*. Chicago: Chicago University Press. [also as 1985 doctoral dissertation, MIT]
- Baker, M. 1995 *The polysynthesis parameter*. New York: Oxford University Press. [also as 1996]
- Barbosa, P. 1996 Clitic placement in European Portuguese and the position of subjects. In A. Halpern, and A. Zwicky, eds., *Approaching second: second position clitics and related phenomena*. Stanford: CSLI.
- Barbosa, P. 1997a A new look at the null-subject parameter. In J. Costa, R. Goedemans, and R. Van de Vijver, eds., *Console IV proceedings*. The Netherlands: SOLE, HIL / Leiden University. [also 1994]
- Barbosa, P. 1997b Subject positions in the null subject languages. *Seminários de lingüística*. 1. 39-63.
- Barss, A., and H. Lasnik. (forthcoming) Quantifier lowering.
- Belletti, A. 1987 Los inacusativos como asignadores de caso. In V. Demonte, and M. Fernández Lagunilla, eds., *Sintaxis de las lenguas románicas*. Madrid: El Arquero.
- Belletti, A. 1988 The case of unaccusatives. *Linguistic inquiry*. 19. 1-34.
- Belletti, A. 1990 *Generalized verb movement*. Torino: Rosenberg & Sellier.
- Bello, A. 1847 *Gramática de la lengua castellana*. Madrid: Arco Libros. [also as 1847 Buenos Aires: Sopena]
- Belvin, R., and M. den Dikken. 1996 *There, happens, to, be, have*. Ms., University of Southern California, and Vrije Universiteit Amsterdam/HIL.
- Belvin, R., and M. den Dikken. 1997 *There, happens, to, be, have*. *Lingua*. 101. 151-183.
- Beneš, E. 1968 On two aspects of functional sentence perspective. *Travaux linguistiques de Prague*. 3.
- Bennett, P. 1996 Canonical form, linguistic diversity and machine translation. Unpublished manuscript, UMIST.
- Bentivoglio, P., and E. Weber. 1986 A functional approach to subject word order

- in spoken Spanish. In O. Jaeggli, and C. Silva-Corvalán, eds., *Studies in Romance linguistics*. Amsterdam: Foris.
- Bentivoglio, P. 1983 Topic continuity and discontinuity in discourse: a study on spoken Latin-American Spanish. In T. Givón, ed., *Topic continuity in discourse. A quantitative cross-language study*. Amsterdam: John Benjamins.
- Benveniste, É. 1966 *Être et avoir dans leur fonctions linguistiques. Problèmes de linguistique générale*. Paris: Gallimard.
- Birner, B., and G. Ward. 1994 Uniqueness, familiarity, and the definite article in English. *Berkeley linguistic society*. 20. 93-102.
- Bobaljik, J., and D. Jonas. 1996 Subjects positions and the roles of TP. *Linguistic inquiry*. 27-2. 195-236.
- Bok-Bennema, R. 1992 Agr-S in Spanish. In D. Gilberts, and S. Looyenga, eds., *Language and cognition*. 2. Groningen: RUG.
- Borer, H. 1984 *Parametric syntax: case studies in Semitic and Romance languages*. Dordrecht: Foris.
- Bošković, Ž. 1994 *Wager-class verbs and existential constructions*. Ms., University of Connecticut, Storrs.
- Bošković, Ž. 1995 Principles of economy in nonfinite complementation. Unpublished doctoral dissertation, University of Connecticut.
- Bosque, I. 1990 *Las categorías gramaticales*. Madrid: Síntesis.
- Bosque, I. 1992 La negación y el principio de las categorías vacías. In V. Demonte, ed., *Estudios de gramática española*. México: Monográfico de nueva revista de filología hispánica.
- Bresnan, J. 1982 Control and complementation. *Linguistic inquiry*. 13-3. 343-434.
- Bresnan, J. 1988 The projection problem: locative inversion in English and in Chichewa. Talk given at MIT on December 2.
- Bresnan, J. 1994 Locative inversion and the architecture of universal grammar. *Language*. 70. 72-131.
- Bresnan, J., and J. Kanerva. 1989 Locative inversion in Chichewa: a case study of factorization in grammar. *Linguistic inquiry*. 20. 1-50.
- Brody, M. 1993 Lexico-logical form - a radically minimalist theory. Ms., UCL.
- Browning, M. 1987 Null operator constructions. Doctoral dissertation, MIT.
- Brucart, J.M. 1987 *La elisión en español*. Barcelona: Publicaciones de la Universidad Autónoma de Barcelona Bellaterra.
- Burzio, L. 1982 Intransitive verbs and Italian auxiliaries. Doctoral dissertation, MIT.
- Burzio, L. 1986 *Italian syntax: a government and binding approach*. Dordrecht: Reidel. [also as 1981 Intransitive verbs and Italian auxiliaries. Doctoral dissertation, MIT]
- Campos, H. 1986 Inflectional elements in Romance. Doctoral dissertation,

UCLA.

- Campos, H. 1997 On subject extraction and the antiagreement effect in Romance. *Linguistic inquiry*. 28. 92-119.
- Campos, H., and M. Zampini. 1990 Focalization strategies in Spanish. *Probus*. 2. 47-67.
- Cardinaletti, A. 1996 Subjects and clause structure. *University of Venice working papers in linguistics*. 6-1.
- Cardinaletti, A. 1997 Agreement and control in expletive constructions. *Linguistic inquiry*. 28. 521-533.
- Cardinaletti, A., and M. Starke. 1994 The typology of structural deficiency: on the three grammatical classes. 24th Linguistic symposium of Romance languages, Los Angeles.
- Chenausky, K. 1990 Case in English existential sentences. Ms., University of Connecticut.
- Chomsky, N. 1957 *Syntactic structures*. The Hague: Mouton.
- Chomsky, N. 1965 *Aspects of the theory of syntax*. Cambridge, Mass.: MIT Press.
- Chomsky, N. 1971 Deep structure, surface structure and semantic interpretation. In D. Steinberg, and L. Jakobovits, eds., *Semantics: an interdisciplinary reader in philosophy, linguistics and psychology*. Cambridge: C.U.P.
- Chomsky, N. 1976 Conditions on rules of grammar. *Linguistic analysis*. 2. 303-352.
- Chomsky, N. 1980 On binding. *Linguistic inquiry*. 11. 1-46.
- Chomsky, N. 1981 *Lectures on government and binding*. Dordrecht: Foris.
- Chomsky, N. 1982 *Some concepts and consequences of the theory of government and binding*. Cambridge, Mass.: MIT Press.
- Chomsky, N. 1986 *Barriers*. Cambridge, Mass.: MIT Press.
- Chomsky, N. 1988 *Generative grammar, studies in English linguistics and literature*. Kyoto University of Foreign Studies.
- Chomsky, N. 1991 Some notes on economy of derivation and representation. In R. Freidin, ed., *Principles and parameters in comparative grammar*. Cambridge, Mass.: MIT Press. [also as 1989 *MIT working papers in linguistics*. 10. 43-74]
- Chomsky, N. 1993 A minimalist program for linguistic theory. In K. Hale, and S. Keyser, eds., *A view from building 20*. Cambridge, Mass.: MIT Press. [also as 1992 *MIT occasional papers in linguistics*] [also published in Chomsky 1995].
- Chomsky, N. 1995 *The minimalist program*. Cambridge, Mass.: MIT Press.
- Chomsky, N. 1998 Minimalist inquiries: the framework. *MIT Working Papers in Linguistics*. 15. [also as 2000 In R. Martin, D. Michaels, and J. Uriagereka, eds., *Step by step: essays on minimalist syntax in honor of Howard Lasnik*. Cambridge, Mass.: MIT Press.]
- Chomsky, N. 1999 Derivation by phase. Ms., MIT.

- Cinque, G. 1981 On the theory of relative clauses and markedness. *The linguistic review*. 1. 247-294.
- Cinque, G. 1983 Island effects, subjacency, ECP/connectedness and reconstruction. Ms., Università de Venezia.
- Cinque, G. 1990 *Types of A-bar dependencies*. *Linguistic inquiry monographs*. 17. [also as 1991]
- Contreras, H. 1976 *A theory of word order with special reference to Spanish*. Amsterdam: North-Holland.
- Contreras, H. 1987 Small clauses in English and Spanish. *Natural language and linguistic theory*. 5. 225-243.
- Contreras, H. 1989 Closed domains. *Probus*. 1. 163-180.
- Contreras, H. 1991 On the position of subjects. *Syntax and Semantics*. 25. 63-79.
- Contreras, H. 1994 Nominative case assignment in Spanish. Syntax roundtable at the University of Washington.
- Contreras, H. 1995 Small clauses and complex predicates. In A. Cardinaletti and M.T. Guasti, eds., *Syntax and semantics*. 28. New York: Academic Press.
- Contreras, H. 1983 *El orden de palabras en español*. Madrid: Cátedra. [also as 1978]
- Cuervo, R.J. 1939 *Apuntaciones críticas sobre el lenguaje bogotano con frecuente referencia al de los países de Hispano-América*. Bogotá: El Gráfico.
- Daneš, F., ed. 1974 *Papers on functional sentence perspective*. The Hague: Mouton.
- Deevy, P. 1998 A processing account of partial agreement effects. Paper presented at the annual meeting of the linguistic society of America, New York City.
- Delbecq, N. 1987 *Problèmes et méthodes de l'étude de la variation syntaxique: le cas de la position du sujet en espagnol*. Louvain: Presses Universitaires de Louvain.
- Diesing, M. 1992 *Indefinites*. Cambridge, Mass.: MIT Press.
- Dikken, M.den. 1995 *Particles: on the syntax of verb-particle, triadic and causative constructions*. New York: O.U.P.
- Dryer, M.S. 1997 On the six-way order typology. *Studies in language*. 21-1. 64-103.
- Dubois, J., and R. Lagane. 1989 *La nouvelle grammaire du français*. Paris: Larousse.
- Dufresne, M., F. Dupuis, and M. Tremblay. 1995 Expletives and change in French: a case in favor of a morphological approach to diachronic syntax. Ms., Université du Québec à Montréal.
- Emonds, J. 1970 Root and structure preserving transformations. Doctoral dissertation, MIT.
- Emonds, J. 1976 *A transformational approach to English syntax*. New York:

Academic Press.

- Emonds, J. 1978 The verbal complex V'-V in French. *Linguistic inquiry*. 9. 151-175.
- Emonds, J. 1980 Word order in generative grammar. *Journal of linguistic research*. 1-1. 33-54.
- Emonds, J. 1985 *A unified theory of syntactic categories*. Dordrecht: Foris.
- Enç, M. 1991 The semantics of specificity. *Linguistic inquiry*. 22. 1-25.
- Epstein, S., and D. Seely. 1999 Specifying the GF 'subject'; eliminating A-chains and the EPP within a derivational model. Ms., University of Michigan.
- Fant, L.M. 1984 *Estructura informativa en español: estudio sintáctico y entonativo*. Upsala: Almqvist and Wiksell International.
- Fernández Fuertes, R. 1996 A comparative analysis of verb-movement effects in English and Spanish: Pollock and the minimalist approach. Ms., University of Ottawa.
- Fernández Ramírez, S. 1951 *Gramática española*. Madrid: Arco Libros. [also 1986]
- Fernández Soriano, O. 1989 Strong pronouns in null-subject languages and the avoid pronoun principle. In P. Branigan, J. Gaulding, M. Kubo, and K. Murasugi, eds., *MIT working papers in linguistics*. 11. 228-239.
- Fernández Soriano, O. 1993 Sobre el orden de palabras en español. *Cuadernos de filología hispánica*. 11. 113-151.
- Fernández Soriano, O., and S. Táboas Baylín. 1999 Construcciones impersonales no reflejas. In I. Bosque, and V. Demonte, eds., *Gramática descriptiva de la lengua española*. Madrid: Espasa.
- Firbas, J. 1966 On defining the theme in functional sentence analysis. *Travaux linguistiques de Prague*. 1.
- Fodor, J. 1983 *The modularity of mind*. Cambridge, Mass.: MIT Press.
- Freeze, R. 1992 Existentials and other locatives. *Language*. 68. 553-595.
- Friedemann, M.A. 1995 Sujets syntaxiques: positions, inversions et *pro*. Doctoral dissertation, Université de Genève.
- Fukui, N., and M. Speas. 1986 Specifiers and projection. *MIT working papers in linguistics*. 8. 128-172.
- García Yebra, V. 1983 ¿Complemento directo o sujeto con las formas unipersonales de *haber*? *Revista de filología española*. LXIII. 33-71.
- Gazdar, G., and G. Pullum. 1980 There is there. *York papers in linguistics*. 8. 199-200.
- Gili Gaya, S. 1943 *Curso superior de sintaxis española*. Barcelona: bibliograph. [also 1969]
- Gili Gaya, S. 1973 *Vox curso superior de sintaxis española*. Barcelona: Bibliograf.
- Gilligan, G. 1987 A cross-linguistic approach to the pro-drop parameter. Doctoral

- dissertation, University of Southern California.
- Goodall, G. 1991 On the status of Spec of IP. *Proceedings of the west coast conference on formal linguistics*. 10.
- Goodall, G. 1993 Spec of IP and Spec of CP in Spanish. *Current issues in linguistic theory. Linguistic perspectives on the Romance languages*. 103. 199-209.
- Greenbaum, S., and R. Quirk. 1990 *A student's grammar of the English language*. London: Longman.
- Greenberg, J.H. 1963 Some universals of grammar with particular reference to the order of meaningful elements. In J.H. Greenberg, ed., *Universals of language*. Cambridge, Mass.: MIT Press. [also as 1966 and 1976]
- Grimshaw, J., and V. Samek-Lodovici. 1995 Optimal subjects. *University of Massachusetts occasional papers in linguistics. Papers in optimality theory*. 18. 589-605.
- Groat, E. 1993 English expletives: a minimalist approach. *Harvard working papers in linguistics*. 3. 81-88.
- Groat, E. 1995 English expletives: a minimalist approach. *Linguistic inquiry*. 26. 354-365.
- Groat, E. 1997 A derivational program for syntactic theory. Doctoral dissertation, Harvard University.
- Haegeman, L. 1994 *Introduction to government and binding theory*. Cambridge, Mass.: Blackwell. [also as 1991]
- Haegeman, L., and J. Guéron. 1999 *English grammar: a generative perspective*. Oxford: Blackwell.
- Hale, K., and S.J. Keyser. 1991 *On the syntax of argument structure*. Cambridge, Mass.: Center for Cognitive Science, MIT.
- Hale, K., and S.J. Keyser. 1993 On the argument structure and the lexical expression of syntactic relations. In K. Hale, and S.J. Keyser, eds., *The view from building 20*. Cambridge, Mass.: MIT Press.
- Halle, M., and A. Marantz. 1993 Distributed morphology and the pieces of inflection. In K. Hale, and S.J. Keyser, eds., *The view from building 20*. Cambridge, Mass.: MIT Press.
- Halliday, M.A.K. 1967 Notes on transitivity and theme in English, part II. *Journal of linguistics*. 3. 199-244.
- Harbert, W. 1995 Binding theory, control, and *pro*. In G. Webelhuth, ed., *Government and binding theory and the minimalist program*. Cambridge, Mass. / Oxford: Blackwell.
- Hatakeyama, Y. 1998 Topic- and focus-topicalizations. *The linguistic review*. 15. 341-359.
- Hatcher, A.G. 1956 Theme and underlying questions. Two studies in Spanish word order. *Word*. 12-3. 2-43.
- Hawkins, J.A. 1983 *Word order universals*. New York: Academic Press.

- Henríquez Ureña, P. 1940 *El español en Santo Domingo*. Santo Domingo: Taller.
- Henry, A. 1995 *Belfast English and standard English*. Oxford: O.U.P.
- Hernanz, M.L., and J.M. Brucart. 1987 *La sintaxis*. Barcelona: Crítica.
- Higginbotham, J. 1987 Indefiniteness and predication. In E. Reuland, and A. ter Meulen, eds., *The representation of (in)definiteness*. Cambridge, Mass.: MIT Press.
- Hoekstra, T., and N. Hyams. 1995 The syntax and interpretation of dropped categories in child language: a unified account. Leiden University and UCLA, manuscript.
- Hoekstra, T., and N. Hyams. 1996 The syntax and interpretation of dropped categories. In J. Camacho, L. Choueri, and M. Watanabe, eds., *Proceedings of the fourteenth west coast conference on formal linguistics*. Stanford: Center for the Study of Language Information.
- Hoekstra, T., and R. Mulder. 1990 Unergatives as copular verbs: locational and existential predication. *The linguistic review*. 7. 1-79.
- Hoekstra, T., N. Hyams, and M. Becker. 1996 The role of the specifier and finiteness in early grammar. University of York Conference on Specifiers, U.K.
- Holmback, H. 1984 An interpretive solution to the definiteness effect. *Linguistic analysis*.13. 195-215.
- Hornstein, N. 1994 An argument for minimalism: the case of antecedent-contained deletion. *Linguistic inquiry*. 25. 455-480.
- Hornstein, N. R. Rosen, and J. Uriagereka. 1994 Integrals. *University of Maryland working papers in linguistics*. 2. 70-90.
- Huang, C.T-J. 1984 On the distribution and reference of empty pronouns. *Linguistic Inquiry*. 15-4. 531-574.
- Huang, C.T-J. 1982 Logical relations in Chinese and the theory of grammar. Doctoral dissertation, MIT.
- Hurtado, A. 1985 La hipótesis de la discordancia. *Revista argentina de lingüística*.
- Jackendoff, R. 1972 *Semantic interpretation in generative grammar*. Cambridge, Mass.: MIT Press.
- Jackendoff, R. 1987 The status of thematic relations in linguistic theory. *Linguistic inquiry*. 21. 369-411.
- Jaeggli, O. 1981 *Topics in Romance syntax*. Dordrecht: Foris.
- Jaeggli, O., and K. Safir. 1989 *The null subject parameter*. Dordrecht: Kluwer Academic Publishers.
- Jang, Y. 1996 Locative inversion and the EPP. *ESCOL'96: proceedings of the thirteenth eastern states conference on linguistics*. 138-147.
- Jelinek, E. 1984 Empty categories, case and configurationality. *Natural language and linguistic theory*. 2. 39-76.
- Jenkins, L. 1972 Modality in English syntax. Doctoral dissertation, MIT.

- Jenkins, L. 1975 *The English existential*. Tübingen: Max Niemeyer Verlag.
- Johnson, K. 1990 The syntax of inflectional paradigms. Ms., University of Wisconsin.
- Johnson, K. 1991 Object positions. *Natural language and linguistic theory*. 9. 577-636.
- Jonas, D., and J.D. Bobaljik. 1993 Spec for subjects: the role of TP in Icelandic. *MIT working papers in linguistics. Papers on case and agreement 1*. 18. 59-98.
- Kampers-Manhe, B. 1997 *Je veux que parte Paul: a neglected construction*. Ms., Groningen University.
- Kany, C.E. 1969 *Sintaxis hispanoamericana*. Madrid: Gredos. [also as 1945 *American-Spanish syntax*. Chicago: University of Chicago Press.]
- Kato, M.A. 1999 Strong and weak pronominals in the null subject parameter. *Probus*. 11. 1-37.
- Kayne, R. 1972 Subject inversion in French interrogatives. In J. Casagrande and B. Saciuk, eds., *Generative studies in Romance languages*. Rowley, Mass.: Newbury House Publishers. [translated as 1973 *L'inversion du sujet en français dans les propositions interrogatives*. *Le français moderne*. 41. 10-42 and 135-151]
- Kayne, R. 1975 *French syntax*. Cambridge, Mass.: MIT Press.
- Kayne, R. 1981 ECP extensions. *Linguistic inquiry*. 12. 93-133.
- Kayne, R. 1984 *Connectedness and binary branching*. Dordrecht: Foris.
- Kayne, R. 1985 L'accord du participe passé en français et en italien. *Modèles linguistiques*. 7-1. 73-91.
- Kayne, R. 1986 Connexité et inversion du sujet. In M. Ronat, and D. Couquaux, eds., *La grammaire modulaire*. Paris: Edition de Minuit.
- Kayne, R. 1989a Facets of past participle agreement in Romance. In P. Benincà, ed., *Dialect variation and the theory of grammar*. Dordrecht: Foris.
- Kayne, R. 1989b Notes on English agreement. Ms., CUNY.
- Kayne, R. 1993 Toward a modular theory of auxiliary selection. *Studia lingüística*. 47. 3-31.
- Kayne, R. 1994 *The antisymmetry of syntax*. Cambridge, Mass.: MIT Press.
- Kayne, R., and J.Y. Pollock. 1978 Stylistic inversion, successive cyclicity, and move NP in French. *Linguistic inquiry*. 9. 595-621.
- Kempchinsky, P. 1996 Perfective auxiliaries, possession and existence in Romance. In K. Zagona, ed., and E.F.K. Koemer, general ed., *Grammatical theory and Romance languages. Amsterdam studies in the theory and history of linguistic science. Current issues in linguistic theory*. 133. Amsterdam/Philadelphia: John Benjamins.
- Kitagawa, Y. 1986 Subjects in Japanese and English. Doctoral dissertation, University of Massachusetts at Amherst.

- Kitahara, H. 1995 Target α : deducing strict cyclicity from derivational economy. *Linguistic inquiry*. 26. 47-77.
- Koopman, H. 1987 On the absence of case chains in Bambara. Ms., UCLA.
- Koopman, H., and D. Sportiche. 1985 Th-theory and extraction. GLOW Colloquium, Brussels.
- Koopman, H., and D. Sportiche. 1991 The position of subjects. *Lingua*. 85. 211-258.
- Korzen, H. 1992 The predicative unit and subject-verb inversion in modern French. In M. Herslund, ed., *Word order. Two studies on central issues in the syntax of Danish and French. Copenhagen studies in language*. 15. Copenhagen: Handelshøjskolens Forlag.
- Kuno, S. 1971 The position of locatives in existential sentences. *Linguistic inquiry*. 2-3. 333-378.
- Kuno, S. 1973 *The structure of the Japanese language*. Cambridge, Mass.: MIT Press.
- Kuroda, Y. 1988 Whether we agree or not: a comparative syntax of English and Japanese. *Linguisticae investigationes*. 12. 1-47.
- Labelle, M. 1990 Unaccusatives and pseudo-unaccusatives in French. *Proceedings of the North East linguistic society*. 20-2. 303-317.
- Laka, I. 1990 Negation in syntax: on the nature of functional categories and projections. Doctoral dissertation, MIT.
- Laka, I. 1993 Unergatives that assign ergative, unaccusative that assign accusative. *MIT working papers in linguistics 18. Papers on case and agreement I*. 149-172.
- Larson, R.K. 1988 On the double object construction. *Linguistic inquiry*. 19. 335-391.
- Lasnik, H. 1981 Restricting the theory of transformations: a case study. In N. Hornstein, and D. Lightfoot, eds., *Explanations in linguistics*. London: Longman.
- Lasnik, H. 1995 Case and expletives revisited: on greed and other human failings. *Linguistic inquiry*. 26-4. 615-633.
- Lasnik, H. 1996 Case and expletives: notes towards a parametric account. In R. Freidin, ed., *Current issues in comparative grammar. Studies in natural language and the linguistic theory*. 35. Dordrecht: Kluwer. [also as 1992 *Linguistic inquiry*. 23-3. 381-405]
- Lasnik, H. 1999 On feature strength: three minimalist approaches to overt movement. *Linguistic inquiry*. 30-2. 197-217.
- Lasnik, H., and J. Uriagereka. 1988 *A course in GB syntax*. Cambridge, Mass.: MIT Press.
- Lasnik, H., and M. Saito. 1984 On the nature of proper government. *Linguistic inquiry*. 15. 235-289.
- Lasnik, H., and M. Saito. 1991 On the subject of infinitives. In L.M. Dobrin, L.

- Nichols, and R.M. Rodríguez, eds., *CLS*. University of Chicago: Chicago Linguistic Society. [also published in H. Lasnik 1999 *Minimalist analysis*. Oxford: Blackwell]
- Leonetti, M. 1999 El artículo. In I. Bosque, and V. Demonte, eds., *Gramática descriptiva de la lengua española*. Madrid: Espasa.
- Levin, B., and M. Rappaport. 1995 *Unaccusativity: at the syntax-lexical semantics interface*. Cambridge, Mass.: MIT Press.
- Liceras, J.M. 1994 La teoría sintáctica y los juicios de gramaticalidad: la posición del sujeto en español. *Revista canadiense de estudios hispánicos*. 18-2. 219-225.
- Liceras, J.M. 1997 La evolución del concepto de parámetro en la teoría lingüística y las consecuencias para la gramática comparada. In P. Fernández Nistal, and J.M. Bravo, eds., *Aproximaciones a los estudios de traducción*. Valladolid: SAE and Universidad de Valladolid.
- Liceras, J.M., and L. Díaz. 1995 Los niveles de representación gramatical y la fijación de parámetros: el problema de la determinación en la adquisición del español como lengua extranjera. Penn State Conference on Acquisition of Spanish as First or Second Language, Penn State University, Pennsylvania.
- Liceras, J.M., and L. Díaz. 1999 Topic-drop *versus* pro-drop: null subjects and pronominal subjects in the Spanish L2 of Chinese, English, French, German, and Japanese speakers. *Second language research*. 15-1. 1-40.
- Liceras, J.M., B. Soloaga, and A. Carballo. 1992 Los conceptos de tema y rema: problemas sintácticos y estilísticos de la adquisición del español. *Hispanic linguistics*. 5. 1-2. 43-88.
- Lightfoot, D. 1979 *Principles of diachronic syntax*. Cambridge: C.U.P.
- Longa, V.M., G. Lorenzo, and G. Rigau. 1998 Subject clitics and clitic recycling: locative sentences in some Iberian Romance languages. *Journal of linguistics*. 34. 125-164.
- Longobardi, G. 1994 Reference and proper names. *Linguistic inquiry*. 25. 609-666.
- Lumsden, M. 1988 *Existential sentences: their structure and meaning*. London: Croom Helm.
- Luque Moreno, J. 1978 En torno al sintagma 'haber impersonal + sustantivo' y sus orígenes latinos. *Revista española de lingüística*. 81. 125-146.
- Lyons, J. 1967 A note on possessive, existential and locative sentences. *Foundations of language*. 3. 390-396.
- Lyons, J. 1977 *Semantics*. London: C.U.P.
- Mahajan, A. 1990 The A/A-bar distinction and movement theory. Doctoral dissertation, MIT.
- Marantz, A. 1991 Case and licensing. *Proceedings of the eastern states conference on linguistics (ESCOL)*.
- Marantz, A. 1995 The minimalist program. In G. Webelhuth, ed., *Government*

- and binding theory and the minimalist program*. Oxford: Blackwell.
- Martínez, J.A. 1999 La concordancia. In I. Bosque, and V. Demonte, eds., *Gramática descriptiva de la lengua española*. Madrid: Espasa.
- Masullo, P.J. 1996 Los sintagmas nominales sin determinante: una propuesta incorporacionista. In I. Bosque, ed., *El sustantivo sin determinación*. Madrid: Visor.
- May, R. 1985 *Logical form*. Cambridge, Mass.: MIT Press.
- Meechan, M., and M. Foley. 1994 On resolving disagreement: linguistic theory and variation –there’s bridges. *Language variation and change*. 6. 63-85.
- Mendicoetxea, A. 1999 Construcciones inacusativas y pasivas. In I. Bosque, and V. Demonte, eds., *Gramática descriptiva de la lengua española*. Madrid: Espasa.
- Milsark, G. 1974 *Existential sentences in English*. Cambridge, Mass.: MIT. New York: Garland.
- Milsark, G. 1977 Toward an explanation of certain peculiarities of the existential construction in English. *Linguistic analysis*. 3-1. 1-29.
- Montes Giraldo, J.J. 1982 Sobre el sintagma ‘haber + sustantivo’. *Thesaurus. Boletín del instituto Caro y Cuervo*. XXXVII. 383-385.
- Morgan, J. 1972 Verb agreement as a rule of English. In P.M. Peranteau, J.N. Levi, and G.C. Phares, eds., *Papers from the eighth regional meeting of the Chicago linguistics society*. University of Chicago.
- Moro, A. 1989 *There, ci* as raised predicates. Ms., MIT.
- Moro, A. 1990 The raising of predicates: copula, expletives and existence. *MIT working papers in linguistics*. 15. 119-181.
- Moro, A. 1991 The raising of predicates: copula, expletives and existence. *MIT working papers in linguistics*. 15. 119-181.
- Motapanyane, V. 1988 Lexical complementizers and focus. Canadian linguistic association annual conference.
- Motta, C. 1996 La representación gramatical de la información nueva en el discurso. Doctoral dissertation, Universitat Autònoma de Barcelona.
- Muromatsu, K. 1997 Two types of existentials: evidence from Japanese. *Lingua*. 101. 245-269.
- Muysken, P. 1982 Parametrizing the notion of ‘head’. *Journal of linguistic research*. 2. 57-75.
- Nathan, G.S. 1981 What’s these facts about? *Linguistic inquiry*. 12. 151-153.
- Ocampo, F. 1989 The pragmatics of word order in spoken Rioplatense Spanish. Doctoral dissertation, University of Southern California.
- Ocampo, F. 1990 The pragmatics of word order in constructions with a verb and a subject. *Hispanic linguistics*. 4-1. 87-127.
- Ocampo, F. 1991 Word order in constructions with a one-valency verb, a subject NP and a PP in Rioplatense Spanish. *Hispania*. 74-2. 409-416.

- Olarrea, A. 1994 Notes on the optimality of agreement. Ms., University of Washington.
- Olarrea, A. 1996 Pre and postverbal subject positions in Spanish: a minimalist account. Doctoral dissertation, University of Washington.
- Ordóñez, F. 1994 Postverbal asymmetries in Spanish. *GLOW newsletter*. 32. 40-41.
- Ordóñez, F. 1997 Word order and clause structure in Spanish and other Romance languages. Doctoral dissertation, CUNY.
- Ordóñez, F., and E. Treviño. 1999 Left dislocated subjects and the pro-drop parameter: a case study of Spanish. *Lingua*. 107. 39-68. [also as 1997 Ms., CUNY and Universidad Autónoma Metropolitana-Iztapalapa].
- Ouhalla, J. 1988 *The syntax of head movement*. Doctoral dissertation, University College London.
- Ouhalla, J. 1990 Sentential negation, relativised minimality, and the aspectual status of auxiliaries. *The linguistic review*. 7. 183-231.
- Ouhalla, J. 1991 *Functional categories and parametric variation*. London: Routledge.
- Ouhalla, J. 1993 Subject extraction, negation, and the anti-agreement effect. *Natural language and linguistic theory*. 11. 477-518.
- Perlmutter, D. 1971 *Deep and surface structure constraints in syntax*. New York: Holt, Rinehart, and Winston.
- Perlmutter, D. 1978 Impersonal passive and the unaccusative hypothesis. *Proceedings of the fourth annual meeting of the Berkeley linguistics society*. 4. University of California, Berkeley: Berkeley Linguistic Society.
- Pesetsky, D. 1997 Optimality theory and syntax: movement and pronunciation. In D. Archangeli, and D.T. Langendoen, eds., *Optimality theory: an overview*. Oxford, Mass.: Blackwell.
- Pesetsky, D. 1989 Language particular processes and the earliness principle. Ms., MIT.
- Piera, C. 1987 Sobre la estructura de las cláusulas de infinitivo. In V. Demonte, and M. Fernández Lagunilla, eds., *Sintaxis de las lenguas románicas*. Madrid: El Arquero.
- Pollock, J-Y. 1982 Accord, chaînes impersonnelles et variables. Université de Paris VIII, unpublished manuscript.
- Pollock, J-Y. 1981 On case and impersonal constructions. In R. May, and J. Koster, eds., *Levels of syntactic representations*. Dordrecht: Dordrecht Hollande.
- Pollock, J-Y. 1983 Accord, chaînes impersonnelles et variables. *Linguisticae investigationes*. 7. 131-181. [also as 1982 Ms., Université de Paris-XII].
- Pollock, J-Y. 1984 II. Ms., Université de Paris-VII.
- Pollock, J-Y. 1989 Verb movement, universal grammar, and the structure of IP. *Linguistic inquiry*. 20-3. 365-425.

- Pollock, J-Y. 1993 Notes on clause structure. Université de Picardie, Amiens, manuscript.
- Postal, P. 1974 On so-called 'pronouns' in English. In D.A. Reibel, and S.A. Schane, eds., *Modern studies in English*. New Jersey: Prentice-Hall.
- Prince, E. 1992 The ZPG letter: subjects, definiteness, and information-status. In W.C. Mann, and S.A. Thompson, eds., *Discourse description: diverse analyses of a fundraising text*. Amsterdam: John Benjamins.
- Prince, A., and P. Smolensky. 1993 Optimality theory: constraint interaction in generative grammar. Ms., Rutgers University and University of Colorado.
- Prince, A., and P. Smolensky. 1997 Optimality: from neutral networks to universal grammar. *Science*. 275. 1604-1610.
- Radford, A. 1997a *Syntactic theory and the structure of English. A minimalist approach*. Cambridge: C.U.P.
- Radford, A. 1997b *Syntax: a minimalist introduction*. Cambridge: C.U.P.
- Reinhart, T. 1991 Elliptic conjunctions: non-quantificational LF. In A. Kasher, ed., *The Chomskian turn*. Oxford: Blackwell.
- Reuland, E. 1982 On the subject of non-argument subjects. Ms., Rijksuniversiteit Groningen.
- Reuland, E. 1983 The extended projection principle and the definiteness effect. In M.Barlow, ed., *Proceedings of the west coast conference on formal linguistics II*.
- Riemsdijk, H.van, and E. Williams. 1986 *Introduction to the theory of grammar*. Cambridge, Mass: MIT Press.
- Rigau, G. 1991 Observaciones sobre la naturaleza de CONC. I Coloquio de gramática generativa, Miraflores de la Sierra.
- Ringqvist, E.L. 1997 Word order and the role of inversion: a comparison between French and Swedish. *Papers and studies in contrastive linguistics*. 32. 65-80.
- Ritter, B. 1988 Existentials, possessives, and locatives in Hebrew. Ms., Université de Québec à Montréal.
- Rivero, M.L. 1978 Topicalization and wh-movement in Spanish. *Linguistic inquiry*. 9. 513-517.
- Rivero, M.L. 1980 On left dislocation and topicalization in Spanish. *Linguistic inquiry*. 11. 363-393.
- Rizzi, L. 1982 *Issues in Italian syntax*. Dordrecht: Foris.
- Rizzi, L. 1986 On the status of subject clitics in Romance. In O. Jaeggli, and C. Silva-Corvalán, eds., *Studies in Romance syntax*. Dordrecht: Foris.
- Rizzi, L. 1990 *Relativized minimality*. Cambridge, Mass.: MIT Press.
- Rizzi, L. 1991 Some speculations on residual V2 phenomena. In J. Mascaró, and M. Nespó, eds., *Grammar in progress. GLOW essays for Henk van Riemsdijk*. Dordrecht: Foris.
- Rizzi, L. 1994 Early null subjects and root null subjects. In T. Hoekstra, and B.

- Schwartz, eds., *Language acquisition studies in generative grammar*. Amsterdam: John Benjamins.
- Rizzi, L. 1995 The fine structure of the left periphery. Ms., University of Geneva.
- Rizzi, L., and I.G. Roberts. 1989 Complex inversion in French. *Probus*. 1. 1-30.
- Roberge, Y. 1986 Subject doubling, free inversion and null argument languages. *Canadian journal of linguistics*. 31. 54-79.
- Roberge, Y. 1990 *The syntactic recoverability of null arguments*. Montreal: McGill-Queen's University Press.
- Roberts, I. 1993 *Verbs and diachronic syntax: a comparative history of English and French*. Dordrecht: Kluwer Academic Publishers.
- Roberts, I. 1997 *Comparative syntax*. London: Arnold.
- Roca Pons, J. 1976 *Introducción a la gramática*. Barcelona: Teide.
- Rochemont, M.S. 1986 *Focus in generative grammar*. Amsterdam/Philadelphia: John Benjamins.
- Rochemont, M.S. 1989 Topic islands and the subjacency parameter. *Canadian journal of linguistics*. 43. 145-170.
- Rochemont, M.S., and P. Culicover. 1990 *English focus constructions and the theory of grammar*. Cambridge: C.U.P.
- Rothstein, S.D. 1995 Pleonastics and the interpretation of pronouns. *Linguistic inquiry*. 26-3. 499-529.
- Runner, J. 1989 Left conjunct agreement in Spanish. Senior thesis, Board of Studies in Linguistics, University of California at Santa Cruz.
- Safir, K. 1982 Syntactic chains and the definiteness effect. Doctoral dissertation, MIT.
- Safir, K. 1985 *Syntactic chains*. Cambridge: C.U.P.
- Safir, K. 1987a So there! A reply to William's analysis of *there*-sentences. In M.A. Browning, E. Czaykowska-Higgins, and E. Ritter, eds., *MIT working papers in linguistics 9. The 25th anniversary of MIT linguistics*. Cambridge, Mass.: MIT Press.
- Safir, K. 1987b What explains the definiteness effect?. In *The representation of (in)definiteness*. Cambridge, Mass.: MIT Press.
- Sánchez-Lefebvre, N. 2000 French pure expletive constructions and move-F. *Cuadernos de lingüística del instituto universitario Ortega y Gasset*. 7. 167-175. [also as 1999 in *Proceedings of Console VII*]
- Schütze, C.T. 1999 English expletive constructions are not infected. *Linguistic inquiry*. 30-3. 467-484.
- Seco, R. 1988 *Manual de gramática española*. Madrid: Aguilar.
- Sgall, P. et al. 1986 *The meaning of the sentence in its semantic and pragmatic aspects*. Dordrecht: Riedel.
- Sgall, P., ed. 1984 *Contribution to functional syntax, semantics and language comprehension*. Amsterdam: John Benjamins.

- Sigurðsson, H. 1996 Icelandic finite verb agreement. *Working papers in Scandinavian syntax*. 57. 1-46.
- Silva-Corvalán, C. 1984 Semantic and pragmatic factors in syntactic change. In J. Fisiak, ed., *Historical syntax*. Berlin: Mouton.
- Smallwood, C. 1997 Dis-agreement in Canadian English existentials. *Proceedings of the 1997 annual conference of the Canadian linguistic association. Calgary working papers in linguistics*. 227-238.
- Smallwood, C. 1998 Agreement in existential and other locative clauses. Ms., University of Toronto.
- Sobin, N. 1994 An acceptable ungrammatical construction. In S.D. Lima, R.L. Corrigan, and G.K. Iverson, eds., *The reality of linguistic rules*. Amsterdam: John Benjamins.
- Sobin, N. 1997 Agreement, default rules, and grammatical viruses. *Linguistic inquiry*. 28. 318-343.
- Speas, M. 1986 *Adjunctions and projections in syntax*. Doctoral dissertation, MIT.
- Speas, M. 1994 Null arguments in a theory of economy of projection. *University of Massachusetts occasional papers in linguistics*. 17. 179-208.
- Speas, M. 1997 Optimality theory and syntax: null pronouns and control. In D. Archangeli, and D.T. Langendoen, eds., *Optimality theory: an overview*. Oxford, Mass.: Blackwell.
- Sportiche, D. 1990 Movement, agreement, constituent structure and case. Ms., UCLA.
- Stowell, T. 1978 What was there before there was *there*. In D. Farkas, W. Jacobsen, and K. Todrys, eds., *Papers from the fourteenth regional meeting*. Chicago: Chicago Linguistics Society (CLS).
- Stowell, T. 1981 Origins of phrase structure. Doctoral dissertation, MIT.
- Suñer, M. 1982a On null subjects. *Linguistic analysis*. 9-1. 55-78.
- Suñer, M. 1982b *Syntax and semantics of Spanish presentational sentence-types*. Washington, D.C.: Georgetown University Press.
- Suñer, M. 1987 *Haber + past participle*. *Linguistic inquiry*. 18. 683-690.
- Suñer, M. 1988 The role of agreement in clitic doubled constructions. *Natural language and linguistic theory*. 6. 391-434.
- Suñer, M. 1994 V-movement and the licensing of argumental wh-phrases in Spanish. *Natural language and linguistic theory*. 12-2. 335-372.
- Szabolcsi, A. 1986 From the definiteness effect to lexical integrity. In W. Abraham, and S. de Meij, eds., *Topic, focus and configurationality*. Amsterdam: John Benjamins.
- Taraldsen, K.T. 1980 On the nominative island condition, vacuous application and the that-trace filter. Indiana University Linguistics Club, unpublished manuscript. [also as 1978]
- Taraldsen, K.T. 1992a Agreement as pronoun incorporation. GLOW colloquium.
- Taraldsen, K.T. 1992b Subject-verb agreement in Celtic and Romance.

Proceedings from NELS, GLSA, Amherst.

- Toribio, A.J. 1993 *Parametric variation in the licensing of nominals*. Doctoral dissertation, Cornell University.
- Torrego, E. 1982 More effects of successive cyclic movement. *Linguistic inquiry*. 13. 561-565.
- Torrego, E. 1983 A look at existential *there be* sentences. Ms., 15 Massachusetts. [also as 1984 Algunas observaciones sobre las oraciones existenciales con *haber* en español. *Estudis gramaticals*. I. Universitat Autònoma de Barcelona]
- Torrego, E. 1984 On inversion in Spanish and some of its effects. *Linguistic inquiry*. 15. 103-131.
- Torrego, E. 1989 Unergative-unaccusative alternations in Spanish. In I. Laka, and A. Mahajan, eds., *MIT working papers in linguistics*. 10. 253-272.
- Torrego, E. 1996 On quantifier float in control clauses. *Linguistic inquiry*. 27. 111-126.
- Torrego, E. (forthcoming) Pronouns and determiners: a DP analysis of Spanish nominals. Ms., University of Massachusetts.
- Travis, L. 1984 *Parameters and effects of word order variation*. Doctoral dissertation, MIT.
- Travis, L. 1989 Parameters of phrase structure. In A.S. Kroch, and M.R. Baltin, eds., *Alternative conception of phrase structure*. Chicago: University of Chicago Press.
- Travis, L. 1991 Derived objects, inner aspect, and the structure of VP. Unpublished manuscript, McGill University.
- Travis, L. 1996 Notes on case and expletives: a discussion of Lasnik's paper. In R. Freidin, ed., *Current issues in comparative grammar. Studies in natural language and linguistic theory*. 35. Dordrecht: Kluwer Academic Publishers.
- Tremblay, M. 1997 On the modularity of case theory. In A-M. Di Sciullo, ed., *Projections and interface conditions. Essays on modularity*. New York/Oxford: O.U.P.
- Uriagereka, J. 1992 A focus position in western Romance. In K. Kiss, ed., *Discourse configurational languages*. Oxford: O.U.P.
- Uriagereka, J. 1994 Extraction parameter. A case study on underspecification. Ms., University of Maryland.
- Uriagereka, J. 1995 Aspects of the syntax of clitic placement in western Romance. *Linguistic inquiry*. 26. 79-124.
- Uribe-Etxebarria, M. 1992 On the structural position of the subject in Spanish, their nature and their consequences for quantification. In J.A. Lakarra, and J. Ortiz de Urbina, eds., *Syntactic theory and Basque syntax*. Donostia: ASJU.
- Vallduví, E. 1992 A preverbal landing site for quantificational operators. *Catalan working papers in linguistics*. 2. 319-343.

- Vergnaud, J.R. 1982 Dépendances et niveaux de représentation en syntaxe. Thèse de doctorat d'état, Université de Paris VII.
- Vergnaud, J.R., and M.L. Zubizarreta. 1992 The definite determiner and the inalienable construction in French and in English. *Linguistic inquiry*. 23. 595-652.
- Ward, G, and B. Birner. 1995 Definiteness and the English existential. *Language*. 71. 722-742.
- Watanabe, A. 1991 Wh-*in situ* subyacency, and chain formation. Ms., MIT.
- Watanabe, A. 1992a Larsonian CP recursion, factive complements and selection. *Proceedings of NELS*. 23-2. 523-537.
- Watanabe, A. 1992b Subjacency and S-structure movement of wh-*in-situ*. *Journal of east Asian linguistics*. 1. 255-291.
- Williams, E. 1984 *There*-insertion. *Linguistic inquiry*. 15. 131-153.
- Woolford, E. 1997 Four-way case systems: ergative, nominative, objective and accusative. *Natural language and linguistic theory*. 15. 181-227.
- Zagona, K. 1982 *Government and proper government of verbal projections*. Doctoral dissertation, University of Washington at Seattle.
- Ziv, Y. 1982 Another look at definites in existentials. *Journal of linguistics*. 18. 73-88.
- Zubizarreta, M.L. 1994 El orden de palabras en español y el caso nominativo. In V. Demonte, ed., *Gramática del español*. México: Publicaciones de la Nueva Revista de Filología Hispánica.
- Zubizarreta, M.L. 1998 *Prosody, focus and word order*. Cambridge, Mass.: MIT Press. [also 1995 University of Southern California, manuscript]
- Zubizarreta, M.L. 1999 Las funciones informativas: tema y foco. In I. Bosque, and V. Demonte, eds., *Gramática descriptiva de la lengua española*. Madrid: Espasa.
- Zwart, C. J-W. 1992 Matching. *Language and cognition*. 2. 349-361.
- Zwart, C. J-W. 1993 SVO languages are head-initial. Ms., University of Groningen.

LIST OF ABBREVIATIONS

[#] features	_____	number features
A-chain	_____	argument chain
Adv	_____	adverbial
AgrP	_____	agreement phrase
AgrS / O	_____	agreement subject / object
alpha-move	_____	alpha movement (alpha being any category)
A-movement	_____	argument movement
A-position	_____	argument position
CH	_____	chain
Cl	_____	clause
CLLD	_____	clitic left dislocation
CON	_____	constraints
CP	_____	complementizer phrase
D-argument	_____	determiner argument
DE	_____	definiteness effect
D-feature	_____	determiner feature
DP	_____	determiner phrase
DR	_____	definiteness restriction

DS	_____	deep structure, D-structure
eBE	_____	existential verb <u>to be</u>
ECP	_____	empty category principle
eNP	_____	existential noun phrase
EPP	_____	extended projection principle
EVAL	_____	evaluator
EXP	_____	expression
F	_____	feature
FF (S)	_____	subject features
FF (V)	_____	verbal features
FI	_____	full interpretation principle
F-move	_____	feature movement
FocP	_____	focus phrase
FP	_____	functional phrase
GB	_____	government and binding
GEN	_____	generator
H	_____	head
iff	_____	if and only if
IP	_____	inflection phrase
ISH	_____	internal subject hypothesis
I-type	_____	it-type pleonastic
LA	_____	lexical array
LD	_____	left dislocation
LEX	_____	lexicon
LF	_____	logical form

LI	_____	item of the lexicon
L-marking	_____	lexical marking
Loc	_____	locative predicate
MI	_____	minimalist inquiries
Mov	_____	movement
MP	_____	minimalist program
MP	_____	mood phrase
NAH	_____	nominative agreement hypothesis
NegP	_____	negation phrase
NeutP	_____	neutral phrase
NP	_____	noun phrase
NP*	_____	subject noun phrase
∅ Agr	_____	null agreement
O	_____	object
O _d	_____	direct object
OEH	_____	overt expletive hypothesis
O _i	_____	indirect object
OT	_____	optimality theory
pBE	_____	passive verb <u>to be</u>
PF	_____	phonetic form
phi-features	_____	formal features
PP	_____	prepositional phrase
PP	_____	principles and parameters
PR	_____	predicate restriction
<i>pro</i> _{expl}	_____	expletive <i>pro</i>

R-expression	_____	referential expression
S	_____	subject
SC	_____	small clause
Spec	_____	specifier
SS	_____	surface structure, S-structure
T-associate	_____	there-associate
ThemeP	_____	theme phrase
theta-roles	_____	thematic roles
TopP	_____	topic phrase
TP	_____	tense phrase
T-type	_____	there-type pleonastic
UG	_____	universal grammar
<i>v</i>	_____	light verb
V	_____	verb
V-features	_____	verbal features
VnP	_____	verbal noun phrase
VP	_____	verb phrase
V-to-I raising	_____	raising of the verb to inflection