



Universidad de Valladolid



**ESCUELA DE INGENIERÍAS
INDUSTRIALES**

**UNIVERSIDAD DE VALLADOLID
ESCUELA DE INGENIERIAS INDUSTRIALES**

Grado en Ingeniería Química

**Optimization and monitoring of two pilots plants: a
mesophilic anaerobic digester and urine diversion
toilets in a context of source separation wastewater
management.**

Autor:

González Salgado, Irene

Fidel Mato Chain

INSA, Toulouse

Valladolid, Julio 2017

TFG REALIZADO EN PROGRAMA DE INTERCAMBIO

TÍTULO: Optimization and monitoring of two pilots plants: a mesophilic anaerobic digester and urine diversion toilets in a context of source separation wastewater management.

ALUMNO: Irene González Salgado

FECHA: 18/07/2017

CENTRO: Institut National des Sciences Appliquées de Toulouse

TUTOR: Etienne Paul and Yolaine Besseire

Abstract

Chemical and pharmaceutical products are ubiquitous in everyday life and recovered in wastewater plants where treatments are not effective enough, expensive and high energy cost, partly because of the huge dilutions of the plants. 65% of the micropollutants studied are found in urine, which represents less of 1% volume in sewage water. Consequently, source separation starts with the evaluation of a urine diversion toilet (UDT). Prototype based on EVAC with vacuum technology is compared to a commercialized Wostman with gravity system. Dilution of urine obtained in Wostman is 79.4% against 3.30% in prototype which represents an adequate value for further treatments but it is not enough enhanced concerning to users acceptance (cleaning and maintenance).

Efficiency of a mesophilic (35°C) anaerobic digester fed with WWTP effluent was evaluated as previous step to degradation of micropollutants analyzes. After 100 days, removal of COD obtained is 58.6 % and methane yield is 54.6%.

Productos químicos y farmacéuticos están generalizados en la vida cotidiana y son recuperados en plantas de aguas (WWTP) donde sus tratamientos son caros, con alto requerimiento energético y no suficientemente efectivos, debido a las altas diluciones de las plantas. 65% de los microcontaminantes estudiados son encontrados en la orina, representan el 1% del residuo entrante. La separación en la fuente empieza con la evaluación de váteres separativos (UDT). El prototipo basado en EVAC con tecnología de vacío es comparado con el comercializado UDT, Wostman con sistema por gravedad. La dilución de la orina obtenida es 79,4% (Wostamn) frente al 3,3% (prototipo), valor adecuado para futuros tratamientos pero aún presenta problemas de aceptabilidad en los usuarios.

Estudio previo a la degradación de microcontaminantes, la eficiencia de un reactor anaerobio mesophilico (35°C) tras 100 días alimentado con el efluente de WWTP presenta 58,6% en eliminación de DCO y en potencial metanogénico 54,6%.

Keywords

Source separation, urine diversion toilets, anaerobic digestion, micropollutants, wastewater treatment

Separación en la fuente, váteres con separación de orina, digestión anaerobia, tratamiento de aguas, microcontaminantes

Acknowledges

Ce travail a été réalisé au Laboratoire d'Ingénierie des Systèmes biologiques et des Procédés (LISBP) au sein de l'équipe « SYMBIOSE » du département de Génie des Procédés et de l'Environnement à l'Institut National des Sciences Appliquées de Toulouse.

Je souhaite remercier Yolaine Bessiere et Etienne Paul, pour m'avoir accueilli, ses conseils et pour tous les bons moments que nous avons pu partager ensemble.

Je remercie Laëtitia Cavallé pour ses conseils, enseignements, tous les aventures vécues dans nos voyages à la station et passer chaque jour avec un sourire.

Je aussi remercie Evrard Mengelle, Mansour Bounouba, Simon Dubos et Chantha Kim pour tout le soutien technique nécessaire à ce travail et le bon climat qu'ils transmettent au labo.

Je remercie tout les stagiaires et doctorants, ils font chaque journée magnifique. En particulier à Léa V pour son grand accueil et aide en premiers jours, Maria la alegría del laboratorio, Coralie ma grande amie merci pour tous les voyages, des amis, fêtes, "croquetas" et des moments que nous avons pu partager. Et surtout Hiba, ma partenaire de danse dans ce projet, traductrice, professeur, élève, collègue de rires et grande amie.

Thanks to Marie, Lorenzo, Patricia, Krish, Victor, Armand, Coralie and all the Gang for this amazing Erasmus.

Merci à tous pour me faire grandir comme professionnelle et surtout comme personne.

Gracias a la Universidad de Valladolid, al programa Erasmus+ y al trabajo del coordinador Raúl Muñoz por darme no sólo la oportunidad de trabajar en un prestigioso laboratorio de ámbito internacional sino de conocer otro idioma, país, cultura y ganar amigos repartidos por todo el mundo.

Por último, gracias a mi madre, mis amigos y familia de España por su apoyo y sus visitas cargadas de sidra, embutido y muchas risas.

Y a mi coloc, ¡por lanzarse conmigo en la aventura de la conquista de la Galia!

Abstract.....	2
Keywords.....	2
Acknowledges	3
1. Introduction.	8
1.1. Decentralized and centralized wastewater management systems.	8
1.2. Project Séparation des Micropolluants à la Source.	10
1.2.1. Context.....	10
1.2.2. Description of SMS project.	11
1.3. Objectives.....	13
Chapter A: Pilot coupling anaerobic mesophilic and aerobic thermophile digestion.	13
2. Bibliographic synthesis: Treatment and recovery of sewage.	13
2.1. Generalities about wastewater treatment plant.....	13
2.2. Characterization of wastewater sludge.....	14
2.3. Characterization of primary sludge.....	16
2.4. Biochemical operations: Aerobic and anaerobic treatments.	17
2.4.1. Aerobic digestion	17
2.4.2. Anaerobic digestion	18
2.4.3. Coupling of anaerobic mesophilic and aerobic thermophile digestion.....	22
3. Materials and methods: Pilot coupling anaerobic mesophilic and aerobic thermophile digestion.....	24
3.1. Description of the pilot plant.....	24
3.2. Pilot monitoring.	27
3.2.1. Physicochemical characterization.....	27
3.2.2. Data analysis.	28
3.3. Operational conditions.	30
3.4. Sample methods.	35
4. Results and discussion.	35
4.1. Performances of pilot coupling anaerobic mesophilic and aerobic thermophile digestion.....	35
4.2. Conclusions.	41
5. Bibliography	42

Chapter B: Urine diversion toilet	44
6. Bibliographic synthesis: Urine diversion toilets.....	44
6.1. Vacuum system in urine diversion toilets.....	44
6.2. International experiences projects base on diversion urine toilets or decentralized wastewater management.....	44
6.3. Urine diversion toilets.....	46
6.3.1. Overview of separate toilets available in the market.....	49
6.3.2. Summary and discussion of urine diversion toilets.	55
7. Materials and methods: urine diversion toilet pilot-scale.....	58
7.1. General description of the pilot-scale.....	58
7.2. Adaption to toilets legislation.....	63
7.3. Evolution and improvements.....	65
7.4. Comparison of EVAC prototype and Wostman EcoFlush.	84
7.5. Evaluation of pilot-scale performance.....	85
8. Conclusions and discussion.....	87
9. Bibliography	88
Annex A- I: PFDs	89
Annex B- I:.....	90
Annex B- II: Toilet Performance Testing Protocol.....	90
Annex B- III: Experiences for evaluating the performance of pilot-scale: water consumption, vacuum required and dilution of the urine.....	90

List of tables

Table 1 Components in wastewater (HENZE and HARREMÖES1997) _____	15
Table 2 Percentage of TOC in wastewater (Torrijos, 2005) _____	15
Table 3 Typical values of interesting variable of untreated domestic water (Tchobanoglous, 2004) Low strength flowrate 750 L/capita-day; medium 460 L/capita-d; high 240 L/capita-day _____	16
Table 4 Parameters of primary sludge (HAMEL 1997). _____	17
Table 5 Typical ratios in municipal WWTP of primary sludge (HENZE et al. 2008) _____	17
Table 6 Characteristics and performance of digest sludge for MAD _____	21
Table 7 Degradation of 9 molecules chosen in MAD, TAR and MAD-TAR treatments. ____	23
Table 8: COD balance diagram _____	28

Table 9 Operational conditions of MAD. *During steady period. Changes were performed because of start-up of settling tanks and disturbances in WWTP inlet. _____	30
Table 10 Characteristics of sludge fed and digested. Biodegradation and methane production _____	31
Table 11 Programs developed for primary decantation _____	32
Table 12 Slope and determination coefficient of total COD removal and CH4 yield _____	40
Table 13 Summary of different urine diversion toilets and vacuum system. Values of prices and unities obtained from von Muench, 2011. _____	55
Table 14 Jet carrier of flushing control mechanism _____	61
Table 15 Quantity of water per flush in function of jet carrier. _____	61
Table 16 Parameters of vacuum interface valves (source: evac.com). _____	62
Table 17 Summary of Toilet Performance Testing Protocol _____	63
Table 18 Test for the evaluation of dilution of urine, water saving and pilot characterization _____	66
Table 19 Evolution of toilet pilot and tests developed _____	69
Table 20 Test toilet paper after vacuum vessel installation in Wostman toilet _____	74
Table 21 Test toilet paper after vacuum vessel installation in Evac toilet _____	74
Table 22 Results of Granule Test in EVAC toilet _____	75
Table 23 Results of Paper Test in EVAC toilet, urine actuator evaluation _____	76
Table 24 First test of water consumption and urine dilution _____	77
Table 25 Analysis of results gathered _____	77
Table 26 Results of test 2 .- Pressing time of faces button (2 seconds, minimum time of pressing and 3 seconds) _____	78
Table 27 Discharge of water in function of the control mechanism _____	80
Table 28 Water consumption and urine dilution in continuous operation mode _____	82
Table 29 Water consumption and urine dilution in discontinuous operation mode _____	83
Table 30 Hydrodynamics performance in function of the control mechanism _____	84
Table 31 Test 6 – Real performance. Dilution of urine and feces in Wostman toilet _____	84
Table 32 Dilution of urine in function of toilet model. _____	85
Table 33 Results test recovery a known quantity of water in urine pipe. _____	86
Table 34 Results influence of pipes system configuration, elbows (-0.70 barg urine pump) _____	86
Table 35 Results influence of pipes system configuration, elbows (-0.50 barg urine pump) _____	86

List of figures

Figure 1 Scheme of the project SMS _____	11
Figure 2 Scheme of the SMS project plant layout: 1. - Working and meeting area 2.-Future urine diversion toilets pilot-scale 3.-Primary settling 4. – Membrane bioreactor 5.-MAD-TAR 6. - Ozonation 7. - Ecotoxicological laboratory _____	12
Figure 3 Reactive scheme for anaerobic digestion. Numbers indicate the bacterial groups involved: 1. Hydrolitic and fermentative bacteria, 2. Acetogenic bacteria, 3. Homo-	

acetogenic bacteria, 4. - Hydrogenotrophic methanogens, 5. Aceticlastic methanogens (HENZE et al. 2008) _____	19
Figure 4 Primary decantation _____	24
Figure 5 MAD-TAR _____	25
Figure 6 COD balance diagram _____	28
Figure 7 Inlet of the WWTP where SMS project is implanted. Values are given in KgTSS _	34
Figure 8 Evolution of methane production and COD inlet _____	34
Figure 9 Total, soluble and particulated COD of MAD feeding _____	37
Figure 10 TSS, VSS and VSS/TSS ratio of MAD feeding _____	37
Figure 11 VSS removal. Grey line corresponds to the beginning of steady period. _____	38
Figure 12 COD removal in duplicated: COD characterization and gas flowmeter and analyzer. First grey line corresponds to the beginning of steady period and second to disturbances in MAD feeding. _____	39
Figure 13 CH ₄ production expressed in gO ₂ versus COD inlet, all accumulated values, First grey line corresponds to the beginning of steady period and second to disturbances in MAD feeding. _____	39
Figure 14 Yield of methane over COD eliminated _____	41
Figure 17 Urine diverting toilet (Source: Dubletten toilet) _____	46
Figure 18 Odor seal of conventional cistern flush _____	48
Figure 19 Urine diversion flush toilet by Dubletten _____	50
Figure 20 Urine diversion flush toilet by Wostman _____	51
Figure 21 Urine diversion flush GUSTAVSBERG toilet _____	52
Figure 22 System of valve opening in Roediger toilet _____	52
Figure 23 Roediger toilet _____	54
Figure 24 Pilot-scaled scheme of urine diversion toilets _____	58
Figure 25 EVAC Optimum Vacuum toilet original _____	59
Figure 26 Initial prototype, EVAC toilet _____	60
Figure 27 Flushing control mechanism of EVAC Vacuum Toilet (source: shop.marinevac.com) _____	61
Figure 28 Scheme initial of pilot-scale toilet _____	68
Figure 29 Final scheme of pilot-scale toilets with pointed out changes. Important changes in color _____	69
Figure 30 Toilet paper problem in EVAC toilet _____	71
Figure 31 Toilet paper problem in Wostman toilet _____	72
Figure 32 EVAC toilet after change in the geometry of urine compartment _____	72
Figure 33 Compartments of the urine diversion toilet _____	73
Figure 34 Metallic grid _____	76
Figure 35 Discharge of water in function of the control mechanism for size 0.40 in bottom position (predefined by manufactured). _____	81

1. Introduction.

1.1. Decentralized and centralized wastewater management systems.

Urban water systems have been a critical importance in the evolution of modern societies. Wastewater management systems are a complex example of interact human-environment. First wastewater collection systems were developed in the United States in mid-1800s (Larsen, Udert, and Lienert 2013), their primary objectives were urban and agricultural areas drainages to prevent the flooding in the streets and improve farming. From those early days, water systems have had to deal with challenges as public health protection, sustainable solutions for a growing global population and maximize the use of recovery water, energy, nutrients and materials.

For facing these demands, wastewater technology and infrastructures has evolved in a large number of management alternatives:

Centralized wastewater system: Collection and drainage of wastewater and sometimes stormwater, from a large, generally urban and peri-urban, area using an extensive network of pumps and piping for transport to a central location for treatment and reclamation (Larsen, Udert, and Lienert 2013). They consist of conventional or alternative wastewater collection systems (sewers), centralized treatment plants, and disposal/reuse of the treated effluent, usually far from the point of origin (Hamilton Booz Allen 2004). This is the commonly system implanted at present.

Source separation wastewater system: Urine is separated from feces and rest of sewage (feces, kitchen, bathroom...) in urine diversion toilets. Urine and black/grey water is collected and drained by dual piping system and separately treated. Nutrients recovery and treatment of micro-pollutants process increases the efficient partly because of the minimization of sewage dilution.

Decentralized wastewater system: self-sufficient infrastructure system that provides the total infrastructure services, for that system type, to individual buildings, clusters of buildings, or small scale communities within a larger municipality, without the aid of centralized infrastructure systems (Hamilton Booz Allen 2004). The wastewater is collected, treated and dispersed or reused at or near the point of generation (Larsen, Udert, and Lienert 2013).

Satellite wastewater system: treatment facilities connected upstream in the centralized wastewater collection system and used for water reclamation near the point of water reuse. Satellite treatment plants generally do not have solids processing facilities; solids are returned to the collection system for processing in

a centralized treatment system located downstream (Larsen, Udert, and Lienert 2013). The size of satellite treatment systems can range from large systems for flows from upstream cities to small systems for source-separated flows in individual buildings. In a lot of cases, technology used is similar to decentralized technology.

Hybrid wastewater system: integration of decentralized, satellite and/or centralized facilities to optimize the performance of urban water and wastewater management systems. In the hybrid model, the centralized facility is used for the processing of excess flow, biosolids and source-separated streams, monitoring and management of remote systems and energy recovery (Larsen, Udert, and Lienert 2013).

It has become increasingly clear in recent years that continued dependence solely on such facilities may not be optimal with respect to sustainable water resources management and especially so in water short areas (Gikas and Tchobanoglous 2009).

Some of the limitations of centralized wastewater systems consist in the difficulty to planning constructions in cities, which often expands too rapidly and are commonly overestimated. Even when demand increases quickly, centralized wastewater treatment plants have been found to operate at 50% or less of their maximum capacity (Mangone 2016), as consequence, solids deposition, grease accumulation and corrosion increase .

To these must be added, the costs of maintenance and operating piping in populations, stricter public policies in waste disposal, economic loses in opportunity cost because of not recovery energy or products of the sewages, elimination of micropollutants in sewage flows presents big difficulties partly because of the high dilution in the wastewater plants...

Despite of these limitations, the practice of building centralized treatment facilities continues at present partly because of previous investment in the collection system infrastructure and existing installations in buildings like piping system.

Future of urban water moving towards decentralized system thanks to some advantages as use of shallow, water-tight infrastructure, not subject a corrosion, that can be installed, maintained and repaired easily; easy implementation of source separation with existing centralized collection system and the ability to eliminate stormwater or other inflow sources better than a centralized system. Furthermore, decentralized or semi-decentralized technologies could allow a better recovery of nutrients and energy present in wastewater plant.

For these reasons, a conception of urban management water in semi-decentralized and decentralized infrastructure systems can be more economical, tend to have less adverse effects on local natural ecosystems and can be designed in normal buildings.

However, new conception of wastewater management system based, for example on source separation and decentralized system has yet to face great challenges in several fields as transport of water, pollutants and residues; treatment process development, operation and monitoring or the transition from previous systems in plants and cities.

1.2. Project Séparation des Micropolluants à la Source.

1.2.1. Context.

Since the 1970s, public water policy has been part of a European framework. Water quality has always been a concern in European Union policy. Community legislation is focused on the use of water (drinking water, bathing, fish farming, shellfish farming) and the reduction of pollution in wastewater and agricultural sewages.

EU Water Framework Directive (WFD 2000 and 2008) setting the objectives for water protection for the future, imposing an improvement in the quality of water and a reduction of micro-pollutant effluents in wastewater treatment plants (Martin Ruel 2012).

A very large majority of micro-pollutants, in particular general medicines (98%) is recovered in urban wastewater and partially degraded in wastewater treatment plants. Micro-pollutants are found in natural environments where they produce negative ecotoxicological effects in the ecosystem. Nowadays, treatments of micro-pollutants in wastewater treatment plants are not effective enough, expensive and high energy cost, partly because of the huge dilutions of the plants.

In addition, 65% of the micro-pollutants studied are found in urine, which represents less of 1% volume in sewage water (Lienert 2012). Not only micropollutants but also phosphorus, nitrogen and potassium are critical elements in plant and animal growth as eutrophication. Furthermore, agriculture is dependent on chemical fertilizers derived from phosphate rock, non-renewable resource with estimates suggesting that approximately 50-100 years remain of current known reserves (Mitchel, Fam 2013). Therefore, source separation of urine could be a useful tool in phosphorus recovery.

micropollutants in living organisms: inhibition of growth and development, neurotoxicity, genotoxicity...

For evaluating the degradation of micro-pollutants in the different process explained, nine micro-pollutants commonly present in wastewater treatment plants were chosen: Diclofenac (DIC), Ibuprofen (IBP), 2-hydroxyibuprofen (2OH-IBP), Carbamazepine (CBZ), Sulfamethoxazole (SMX), Ofloxacin (OFL), Oxazepam (OXA), Propranolol (PRO), and Caffeine (CAF). It is developed an own protocol (not explained in this rapport) based on QuEChERS extraction for the analysis of these molecules in the different matrices of the process.

QuEChERS (Quick, Easy, Cheap, Effective, Rugged and Safe) was introduced in 2003 by Anastassiades for the determination of pesticide residues in fruits and vegetables (Anastassiades et al., 2003). Interest for the QuEChERS extraction method has increased continually and it is applied in many studies matrices and analytes.

Implementation of the project is carried out in a platform located in wastewater treatment plant of SIVOM de la Saundrune at Cugnaux (France). The sewage water is settled the primary sludge is sent to MAD-TAR. Water supernatant is sent to the membrane bioreactor. Urine diversion toilet pilot-scale plant is installed in LISBP laboratory.



Figure 2 Scheme of the SMS project plant layout: 1. - Working and meeting area 2.- Future urine diversion toilets pilot-scale 3.-Primary settling 4. - Membrane bioreactor 5.- MAD-TAR 6. - Ozonation 7. - Ecotoxicological laboratory

1.3. Objectives.

This report is focused on two parts of the SMS project: optimization of urine diversion toilet pilot-scale and evaluation the sludge treatment anaerobic digester.

- Description of start-up of two settles of semi-industrial size where sewage water settles for generating primary sludge, which will be utilized in next processes.
- Description of the pilot-scale of semi-industrial size where is carried out the treatment of the primary sludge: platform of MAD-TAR
- Monitoring the parameters of the pilot-scale of semi-industrial size of MAD for further comparison with MAD-TAR coupling process.
- Bibliographic overview of anaerobic and aerobic sludge treatment.
- Bibliographic overview of different source separation project carried out and types of urine diversion toilets.
- Description of pilot-scale diversion toilets installed in SMS project and its evolution.
- Evaluation of the acceptance of diversion toilets in users.
- Developed of a protocol for testing urine diversion toilets with sewage vacuum system based on an adaptation to the current norms of conventional toilets.

Chapter A: Pilot coupling anaerobic mesophilic and aerobic thermophile digestion.

2. Bibliographic synthesis: Treatment and recovery of sewage.

2.1. Generalities about wastewater treatment plant.

Wastewater treatment plant involves different processes to remove pollutants in wastewater.

These processes are grouped as preliminary treatment (screening, grit removal, flotation...) where sand is settled and grease are separated by flotation. Then it is followed a primary decantation which originates sludge called *primary*. Secondary treatment removes biodegradable organic matter (in solution or

suspension) and suspended solids, which generate sludge called *secondary*. Tertiary treatments could complete the process to remove residual suspended solids after secondary treatment (usually by granular medium filtration or microscreens), and insure disinfection is also typically in tertiary treatment.

In a wastewater treatment process is found four general categories of pollutants: soluble organic matter, insoluble organic matter, soluble inorganic matter and insoluble inorganic matter. The last one is typically eliminated by preliminary physical treatments above-mentioned.

Main role of biochemical operations is remove soluble organic matter. Microorganisms used it as a food source, converting carbon into new biomass and CO₂ (aerobic digestion). CO₂ is evolved as a gas and biomass is removed by decanting.

Insoluble organic matter can be removed by settling but wastewater often contains colloidal organic matter that is not possible to remove in this way. For this reason, after settling, it is stabilized by anaerobic or aerobic treatments which origins as products CO₂, inorganic solids and insoluble organic residues relatively resistant to further biological activity.

Conversion of soluble inorganic matter, majority nutrients as P or N, is object of WWTPs for avoiding problems caused in the environment as eutrophication. Phosphorus is present in form as orthophosphate, condensed phosphates and organic phosphate. As result of microbial activity, last two are converted to orthophosphate which is removed by specialized bacteria that store large quantities of it in granules within the cell. Nitrogen is present as ammonia and as organic nitrogen (protein, amino acids...). Last one is converted to ammonia as result of organic matter biodegradation.

2.2. Characterization of wastewater sludge.

Wastewater collected in wastewater treatment plant is formed by domestic and municipal water and rain water. It has a huge number and variability of components. Its characteristics differ not only in different regions and countries but also in different moments of the year and even of the day. Table 1 shows the components which could be found in a domestic and municipal wastewater without any essential industrial influence and the associated environmental effects.

Table 1 Components in wastewater (HENZE and HARREMÖES1997)

Component	Special interest	Environmental effects
Micro-organisms	Pathogenic bacteria, virus and worms eggs	Risk when bathing and eating shellfish
Biodegradable organic materials	Oxygen depletion in rivers, lakes and fjords	
Other organic materials	Detergents, pesticides, fat, oil and grease, colouring, phenol, solvents	Toxic effect, aesthetic inconveniences, bio accumulation
Nutrients	Nitrogen, phosphorus, ammonia	Eutrophication, oxygen depletion, toxic effect
Metals	Hg, Pb, Cd, Cr, Cu, Ni	Toxic effect, bio accumulation
Other inorganic materials	Acids (H ₂ S)	Corrosion, toxic effect
Thermal effects	Hot water	Changing living conditions for flora and fauna
Odour	H ₂ S	Corrosion, toxic effect
Radioactivity	Toxic effect, accumulation	Aesthetic inconveniences, toxic effect

Proteins and sugars are the majority components in wastewater. Table 2 shows the average repartition of constituents of a wastewater expressed in TOC (Total Organic Carbon).

Table 2 Percentage of TOC in wastewater (Torrijos, 2005)

Components	% TOC
Polysaccharides	31.2
Monosaccharides	11.7
Proteins	24.5
Free amino acid	6.5
Anionic detergents	7.9
Non-anionic detergents	4.4
Urea	1.8
Uric acid	0.8
Creatinine	1.5

Table 3 presents typical data concentration of the components encountered in untreated domestic wastewater. The data for medium strength is based on an average flow of 460 L/capita-day. It is also given the concentrations for low

strength (240L/capita-day) and high strength (750 L/ capita-day) wastewater flow which reflect different amounts of infiltration.

It should be notice that wastewater has a huge variability, components and concentrations can suffer variations depending of contributors to wastewater system. Consequently, Table 3 can only be used as a reference. Data was collected from a wastewater collection system in United States (Tchobanoglous, 2004).

Table 3 Typical values of interesting variable of untreated domestic water (Tchobanoglous, 2004) Low strength flowrate 750 L/capita-day; medium 460 L/capita-day; high 240 L/capita-day

Parameters	Low strength (m/L)	Medium strength (mg/L)	High strength (mg/L)
Solids, total (TS)	390	720	1230
Suspended solids, total (TSS)	120	210	400
Volatile	95	160	315
Chemical oxygen demand (COD)	250	430	800
Nitrogen (total as N)	20	40	70
Free ammonia	12	25	45

2.3. Characterization of primary sludge.

Primary sludge is the result of the transformation and accumulation of soluble molecules and particular molecules which formed organic matrix of the sewage water. The nature of the materials in primary sludge tends to be very diverse because of the multitude of sources. The objective of treatment by sedimentation is to remove settling solids and floating material for reducing the content in suspended solids.

Primary sedimentation tanks in WWTP should have removal efficiency from 50 to 70% of the suspended solids and from 25 to 40% of the BOD from wastewater inlet (TCHOBANOGLIOUS, BURTON, and STENSEL 2004).

Table 4 shows characteristic of primary sludge, found in the literature, and it will permit to compare the efficiency of the settling tanks of our study. There are not physicochemical preliminary treatments as coagulation or flocculation in project SMS.

Table 4 Parameters of primary sludge (HAMEL 1997).

Parameters	Primary sludge
TSS (g/L)	12
VSS %TSS	65
pH	6
C/N	11.4
P %MS	2
Cl %MS	0.8
K %MS	0.3
Al %MS	0.2
Ca %MS	10
Fe %MS	2
Mg %MS	0.6
PCI kWh/t MS	4200

The ratio between the various components in wastewater has significant influence on the selection and performance of the process. Ratio VSS/TSS of primary sludge gives an idea of their digestibility in anaerobic conditions. When the suspended solids have a high volatile component, ratio VSS/TSS between 0.8-0.9, they can be successfully digested. Other representative ratio utilized is COD/VSS. Typical ratios of COD/VSS and VSS/TSS for high, medium and low organic load in a WWTP are found in Table 5.

Table 5 Typical ratios in municipal WWTP of primary sludge (HENZE et al. 2008)

Ratio	High	Medium	Low
COD/VSS	1.6-2.0	1.4-1.6	1.2-1.4
VSS/TSS	0.8-0.9	0.6-0.8	0.4-0.6

2.4. Biochemical operations: Aerobic and anaerobic treatments.

2.4.1. Aerobic digestion

After preliminary treatments and decantation in WWTPs, primary sludge is treated in aired continuous stirred tank reactor. Three main mechanisms are involved in the process: hydrolysis of substrate, growth and reproduction of microorganism and cell lysis.

In aerobic oxidation, conversion of organic matter is carried out by mixed bacterial cultures with next stoichiometry (TCHOBANOGLIOUS, BURTON, and STENSEL 2004):

Oxidation and synthesis:

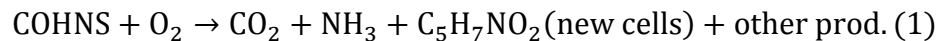

Endogenous respiration:

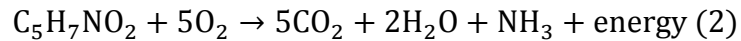

Organic matter (COHNS) is the electron donor while oxygen is the acceptor.

Under suitable conditions the process proceeds towards biological nitrogen removal: nitrification and denitrification.

Nitrification process has two steps: ammonia is oxidized to nitrite by autotrophic bacteria, Nitrosomas and nitrite is oxidized to nitrate by autotrophic bacteria, Nitrobacter. Optimum conditions of pH are 7-9 and the dissolved oxygen should be more than 1.5 mg/L.

Total oxidation reaction:

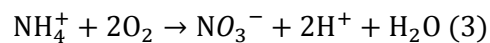

Denitrification involves the biological oxidation of many organics substrates by bacteria heterotrophic. This process occurs during an anaerobic period and involve following steps from nitrate to nitrite:

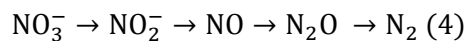

Reaction stoichiometry for wastewater as electron donors:

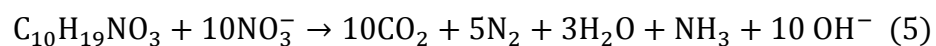

2.4.2. Anaerobic digestion

Anaerobic degradation of organic matter involves four step processes of series and parallel reactions: hydrolysis, acidogenesis, acetogenesis and methanogenesis according to. The microbial consortia convert complex organic matter in CH_4 , NH_3 , H_2S and H_2O .

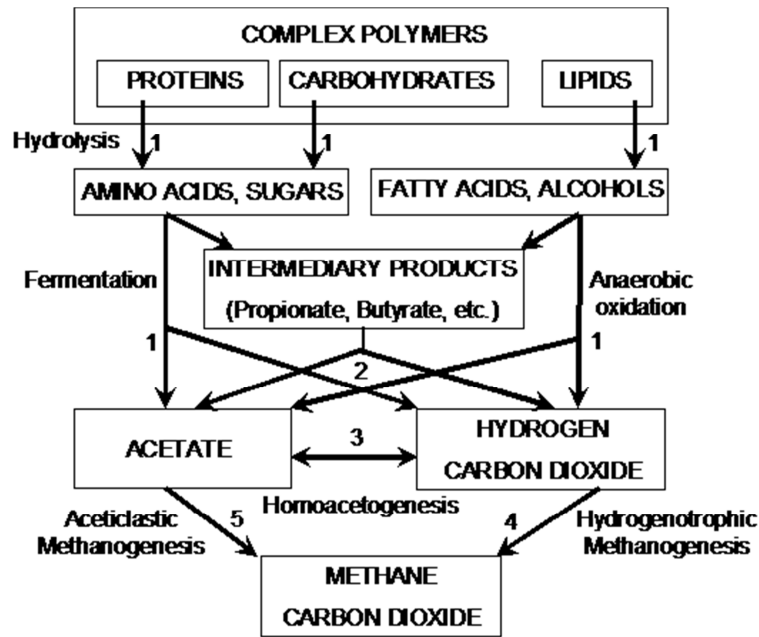

Figure 3 Reactive scheme for anaerobic digestion. Numbers indicate the bacterial groups involved: 1. Hydrolytic and fermentative bacteria, 2. Acetogenic bacteria, 3. Homo-acetogenic bacteria, 4. - Hydrogenotrophic methanogens, 5. Aceticlastic methanogens (HENZE et al. 2008)

Hydrolysis of biopolymers

First step in anaerobic degradation consists of the hydrolysis of proteins, polysaccharides and fats. Polymer particles are degraded into fewer complexes and dissolved components which can enter within the cell walls and membranes of the acidogenic bacteria. Enzymes excreted by fermentative bacteria (called “exo-enzymes”) carry out this step.

Acidogenesis

During this stage, products from hydrolysis (amino acids, simple sugars, alcohols...) are diffused inside the bacterial cells and fermented or anaerobically oxidized. The products consist of a variety of small organic compounds mainly volatile fatty acids (VFAs) and higher organic acids such as propionate and butyrate, such as CO₂, H₂, some lactic acids, ethanol and ammonia. VFAs and carbonic acid are the main products.

Acidogenesis reactions with sucrose as substrate (HENZE et al. 2008):

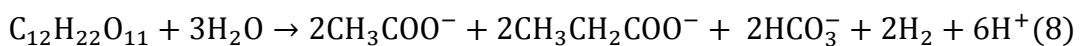
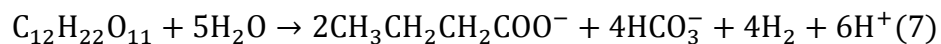

Acetate will be the main product due to equation 6 if H₂ is well removed by methanogens microorganisms. If methanogenesis is retarded and H₂ is accumulates, other products as propionate and butyrate, or even more reduced products as alcohol and lactate, will be present in large quantities.

Acetogenesis

Acetogenic bacteria use as main substrate propionate and butyrate for the conversion of the short chain fatty acids (SCFA) produced on acidogenesis, into acetate, CO₂, H₂.

Acetogenic bacteria produce H₂, so their metabolism is inhibited by the presence of too H₂. For this reason it is necessary to reach equilibrium between H₂-producing acetogenic bacteria and H₂-consuming methanogenesis bacteria which gets decrease partial H₂ pressure to 10⁻⁴ atm. In this way, it is regulated the H₂ level in the environment and acetogenesis reactions of ethanol, butyrate and propionate, which are thermodynamically unfavorable as positive ΔG indicates (see values and reaction in HENZE et al. 2008, p.420), can take place.

Methanogenesis

It is the final step where organic matter is converted in CH₄ and CO₂.

Methanogenic bacteria are obligate anaerobes, so few substrates can be used, for example: acetate, methylamines, methanol, CO. Two methanogenesis reactions take place:

Acetotrophic methanogenesis:

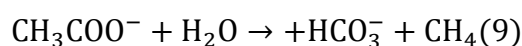

Hydrogenotrophic methanogenesis:

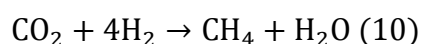

Generally about 70% of the produced methane originates from acetate and the rest is from CO₂ and H₂.

The growth rate of acetoclastic methanogens is very low; it could be take several days or more. For this reason, the start-up of a reactor is complicated and long with misfit seed material. In the other hand, hydrogenotrophic bacteria have a higher growth rate. Consequently, anaerobic reactor systems have a huge stability under varying conditions.

Overall methanogenesis yield between 0.02-0.06 gVSS/gCOD soluble (Tchobanoglous et al. 2004), 0.03 gVSS/gCOD total (Henze et al. 2008).

For treating high organic loading rates in an anaerobic reactor system:

Sludge Retention Time (SRT) for treating an anaerobic reactor system is an important parameter. The higher the amount of sludge is retained, the higher will be the loading potential system (HENZE et al. 2008). Experiences from Perez, 2009 showed this fact, CH₄ yield calculated at 21 days SRT was 30 % for MAD and with 42 days SRT yield was increase until 41%.

Representative parameters of an anaerobic performance are presented in next table:

Table 6 Characteristics and performance of digest sludge for MAD

	MAD digested		
	30 ^a	20 ^a / 21 ^b /20 ^c	42 ^a
Temperature (°C)	37.0 ± 0.5 ^a	37.0 ± 0.5 ^a /35 ^b /37 ^c	35 ^a
Ammonium (g-N-NH ₄ /L)	0.77±0.01 ^a	1.0±0.1 ^a	-
COD total (g/L) (median)	14.7± 1.2 ^a	13.9±0.9 ^a /2.6-8.0 (4,5) ^b	5.1-6.3 (5.8) ^a
COD soluble (g/L)	1.2± 0.3 ^a	0.62±0.23 ^a / 0.2- 0.5 (0.3) ^b	0.1-0.6 (0.45) ^a
COD total removal (%)	60.6± 3.1 ^a	67.5±3.3 ^a / 32.3 ^b / 61 ^c	41.6
TSS (g/L)	25.5± 3.7 ^a	13.8±1.4 ^a /3.6-5.5 (4.6) ^b	4.0-6.5 (5.8) ^a
VSS (g/L)	11.8± 0.8 ^a	8.8±0.7 ^a / 2.5 -3.7 (3.4) ^b	2.5-4.8 (4.3) ^a
VSS removal (%)	57.9± 5.3 ^a	62.1±3.6 ^a / 30 ^b	44 ^a
Biogas composition (%CH ₄)	61.15± 0.5 ^a	58.9±1.1 ^a	-
Methane production	--	30.1 ^b /60 ^c	41.1 ^a

References: a) Gonzalez et al, 2016, b) Dumas et al 2009, c) Wendland et al 2007.

There are two principal forms of inorganic ammonia nitrogen in aqueous solution: Ammonium ion (NH₄⁺) and free ammonia (NH₃). NH₃ has been considered to be the main inhibitor. Ammonia is considered as an inhibitor of slowing down the growth and metabolic rates. (Rajagopal et al.,2013).

Values 1.5-3.0 g N-NH₄⁺/L of ammonium ion is considered as medium inhibitor of anaerobic digestion and values upper than 3.0 g N-NH₄⁺/L are strong inhibitor (MOLETTA et al, 2004)

2.4.3. Coupling of anaerobic mesophilic and aerobic thermophile digestion.

Using conventional biological processes, a great part of the sludge COD (45–70%) remains refractory (Dumas et al. 2010) because of the difficulty of dissolving and hydrolysis of proteins, sugars and fats, which are the critical stages in digestion of sludge. They are probably ExoPolymeric Substances (EPS), organized in a gel-like matrix (Perez, 2009).

Operational parameters as temperature or hydraulic residence time (SRT) are generally evaluated.

Anaerobic digesters can be operated under mesophilic (30–40 °C) or thermophilic (50–60 °C) conditions and a fraction of the slowly biodegradable Chemical Oxygen Demand (COD) is in fact not degraded, regards to the retention times usually applied to digesters. (Dumas et al. 2010)

During the thesis of Sergio Perez, 2009 carried out in the same team as project SMS, the efficiency of thermophilic (65 °C) aerobic process coupled with a mesophilic (35 °C) digester was evaluated for the activated sludge degradation and was compared to a conventional mesophilic digester. With a SRT of 42 days, the COD removal yield was around 30 % higher with MAD-TAR co-treatment. An increase of the sludge intrinsic biodegradability is observed (20 – 40 %), showing that COD, non-biodegradable in mesophilic condition, becomes bioavailable. However, the mechanization yield was quite similar for both processes at a same SRT.

Concerning removal of micro-pollutants present in wastewater chosen, the efficiency of MAD, TAR and MAD-TAR treatments found in literature is shown in Table 7, for different SRT.

Results have a big variety partly because complexity of micropollutants analysis and as expected degradation of micropollutants increases with SRT.

Co-treatment MADTAR is yet an immature process, so few studies that compares the degradation of conventional MAD or TAR with the hybrid process MAD-TAR were found, except for diclofenac and ibuprofen, which are quick easily biodegradable compounds in MAD and TAR processes and they do not justify MAD-TAR treatment concerning to their degradation.

Reported efficiency of MAD-TAR versus MAD treatment will be next step in project SMS, but it is not the aim of this rapport.

Table 7 Degradation of 9 molecules chosen in MAD, TAR and MAD-TAR treatments.

Molécule	% dégradation par MAD	% dégradation par TAR	% dégradation par MAD-TAR
Carbamazepine (CBZ)	0% ^b / 15% ^h / 0% (SRT=10,20,30) ⁱ / 50±4 % (SRT=10) / 51±3 %(SRT=15) / 53±4% (SRT=20) ^j	7% ^h / 48±2 % (SRT=7) / 50±4% (SRT=15) / 54±3% (SRT=20) ^j	35% ^c
Ibuprofen (IBP)	95% ^d / 82% ^e / 17% ^h / 0% (SRT=10) 22,5% (SRT=20) / 10% (SRT=30) ⁱ	94% ^d / 28% ^h	96% ^d
Diclofenac (DFC)	20% ^b / 95% ^d / 24% ^h / 0% (SRT=10,30) 5% (SRT=20) ⁱ / 51±3 % (SRT=10) / 60±3 (SRT=15) / 66±5 (SRT=20) ^j	96% ^d / 25% ^h / 52±4 % (SRT=7) / 67±4 %(SRT=15) / 71±6 %(SRT=20) ^j	98% ^d
Sulfamethoxazole (SMX)	100% ^b		85% ^c
Ofloxacin (OFL)	45% ^b		
Caffeine (CAF)	98% ^b / > 99,6 % ^h / 98%(SRT=10, 20, 30) ⁱ	99,7% ^h	
2-hydroxyhybuprofene (hydroxy-IBP)			
17b- estradiol (E2)	27% ^h	18% ^h	
Oxazepam (OXA)	85% ^h	84% ^h	
(S)-(-)-Propranolol hydrochloride (PRO)	1% ^h	2% ^h	

References: a)Carballa et al, 2008; b)Narumiya et al, 2013; c)Gonzalez et al, 2016; d)Samaras et al, 2014; e)Samaras et al, 2013; f)Carballa et al, 2010; g)Lachassagne et al, 2015; h)Malmborg et al, 2015; i) STEP dommartin (Thèse Pomiès); j)Projet ampères (France); k)Thèse Pasquini 2013 (France); l)Peysson & Vulliet 2013 (France); m)Loos et al. 2013 (90 EU WWTPs); n)Mailler et al. 2015; ñ)Martin et al. 2015; o)Perlicchi et al. 2012; p) Ferrando et al. 2012; q)Larsson et al. 2014; r) Yang et al,2017

3. Materials and methods: Pilot coupling anaerobic mesophilic and aerobic thermophile digestion.

3.1. Description of the pilot plant.

As explained above in 1.2. *Project Séparation des Micropolluants à la Source*, pilot coupling MAD-TAR treatment was installed in the platform number 5 of the project.

Next figures represents the primary decantation and coupling anaerobic mesophilic digester (MAD) and aerobic thermophile reactor (TAR).

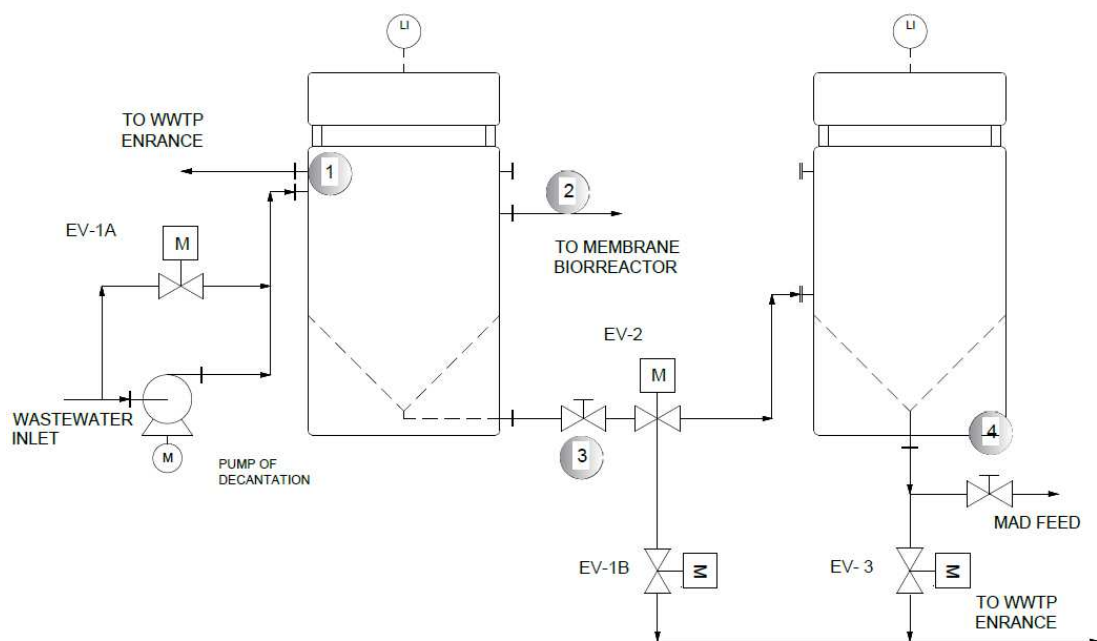

Figure 4 Primary decantation

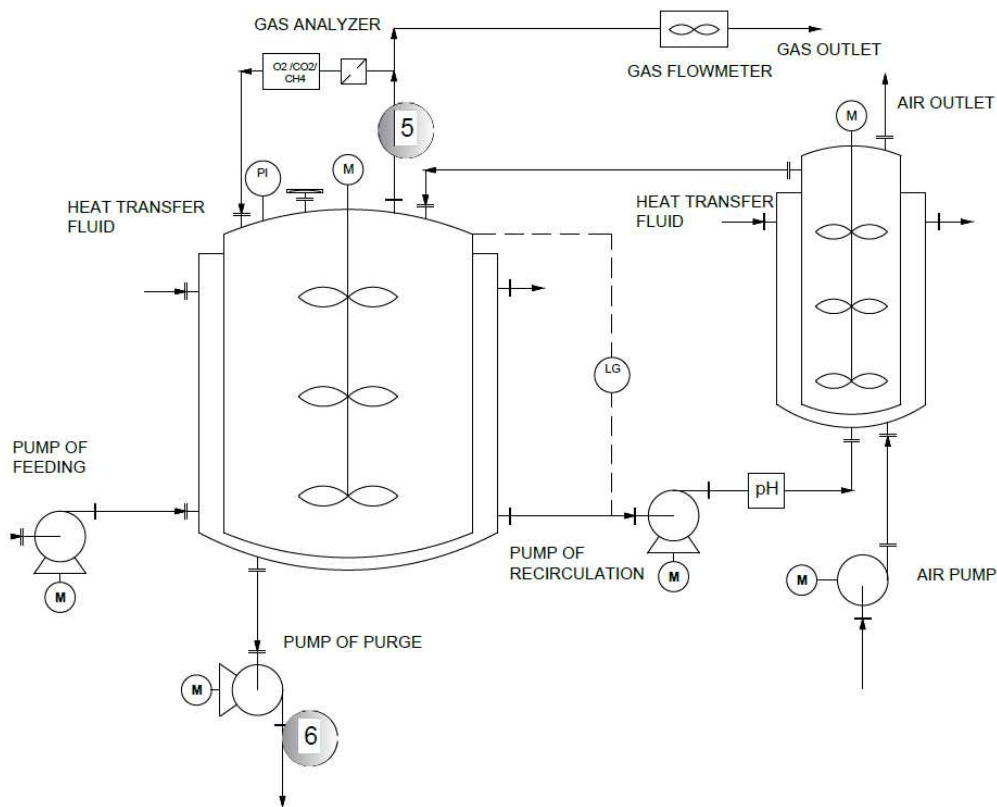

Figure 5 MAD-TAR

Inlet wastewater from the WWTP enters to a primary settle by an ALBIM pump with a fix flow of 100-160 L/hour, where supernatant is sent as feed of the Membrane Bioreactor (500 L/day), and sludge settled flows to a thickener settler whose objective is to increase the dryness of the sludge feeding the MAD-TAR (400 gMVS/day).

MAD-TAR is composed of a mesophilic anaerobic digester (MAD) and a thermophilic aerobic reactor (TAR). MAD is a 500L tank with a double envelope whose work temperature is 35°C. A U-tube and a level sensor let measure the level of the reactor. By an ALBIN pump, called pump of recirculation MAD is connected to TAR, tank of 50 L as well with a double envelope whose work temperature is 65°C. Pump of recirculation has a flow of 100L/h and it is worked four times per day due to the program. Double enveloped of both tanks are heated by two cryostat at 65 °C and 35°C to maintain the suitably temperature for the process. TAR has installed a pump for supplying the micro-aeration in the bottom and an Oxygen sensor, air flows until the top and go out to the atmosphere for keeping a micro-aerated condition (air can enter in the TAR only by the pump). Both reactors are equipped with stirrers.

Primary sludge from the second settle is feeding to the top of the MAD by an ALBIN pump, purge of sludge is made by other ALBIN pump in the bottom of the MAD. Useful value of MAD and TAR are 450 L and 40 L of sludge respectively.

For security reasons MAD is equipped with a rupture disk with a security pressure of 5 bara. Furthermore it is installed a pressure gauge.

The biogas produced in the MAD is analyzed in XStream gas analyzer and returned to the tank. XStream analyses concentration of CH₄, CO₂, O₂ y H₂S and it is installed a filter to remove water vapor before XStream.

The pressure in the tank is kept slightly above 1 bar thanks to the gas flowmeter Ritter which counts the volume of biogas produced.

The scrapers and turbine of the MAD are manually operated. Cryostat pumps as well as supply, purge and recirculation pumps connected to the tanks, TAR agitation and TAR aeration can be controlled remotely by the controller SIEMENS. A control panel is available in the control cabinet. It can be manipulated remotely from other computers thanks to the software Team Viewer, the installation being equipped with 4G.

The values of the individual sensors, analyzer and Ritter are recorded every five minutes. As well as the binary position (active or nor) of the pumps, cryostat, TAR aeration, TAR agitation and it is also recorded the parameters involved in previous decantation: electric valves and level sensors of the settles. The circuit is calibrated in 4-20mA: depending on the measured value, an influx proportional to this value is returned and registered in an EXCEL archive.

The controller is connected to a computer, itself connected to TeamViewer, for remote control and monitoring of data. An Excel file with the data reading every five minutes is accessible.

Ritter

The measurement of RITTER TG-05 drum-type gas meters works on the principle of displacement. The gas flow causes a rotation of the measuring drum within a packing fluid (low viscous oil). It can measure flow rates from 1 L/h (minimum) until 60 L/h (maximum). Outlet in the top of the MAD is connected to the Ritter, which measure and send the flow to the atmosphere.

During the purge of sludge, air enters the reactor because of the depression generated by purging, causing the rotation of the Ritter in the other direction, thereby decreasing the liters measured. It is noted because it could affect the yield of methane production because of inlet of oxygen

Gas analyzer

Xstream model X2GP analyses continuously the gas flow from the top of the MAD feeding by a peristaltic pump. It measures the concentration of CH₄, CO₂ and O₂. Vapor of water is previously filtered. Gas analysis is performed by non-dispersive measurement (UV/VIS photometer). The absorbed wavelength of the gas makes possible to identify the component, while the quantity of light absorbed makes it possible to quantify its proportion.

3.2. Pilot monitoring.

3.2.1. Physicochemical characterization.

The characterization of the pollution to be treated biologically generally uses molecular size discrimination (settled, non-settled, dissolved), by chemical (mineral, organic) distribution and by degree of biodegradability (easily, difficultly and non-biodegradable). The results presented are related to the first two classifications and the related analytical methods are described in this section:

COD: Determination of the chemical oxygen demand is carried out on the total sample and on the filtered supernatant by the potassium dichromate method (AFNOR T90-101, 1969). The materials which are be able to be oxidized in the sample (2 mL of crude or diluted sample) are oxidized by an excess of potassium dichromate in an acid medium (H₂SO₄) under hot conditions (2 hours at 150 °C.). The COD assay is carried out by micro-method and spectrophotometric measurement using HANNA Instruments COD reagent LR and MR for COD ranges of 0 - 150 mg / L (CR VI in excess at 420 nm) and 0-1500 mg/L (Cr III formed at 620 nm).

TSS (Total Suspended Solids) and **VSS** (Volatile Suspended Solids): 50 mL of sample are centrifuged (15 min at 5000 rpm). It is obtained the supernatant and the solid matter; it is finally recovered in an aluminum cup pre-dried and weighed (m₀) at 105 °C. After 24 hours at 105 °C, the cup and its contents are weighed again (m₁). This same capsule is finally placed 2 hours at 500 ° C., which makes it possible to eliminate volatiles calcination. The cup is weighed after calcination (m₂).

$$TSS = \frac{m_1 - m_0}{V} \quad (11)$$

$$VSS = \frac{m_1 - m_2}{V} \quad (12)$$

Ion chromatography: Technique for the analysis of inorganic or organic ionic species in complexes mixtures in solution. Solution passes through a column containing a charged stationary phase, qualifying and quantifying its ions according to their migration speed. Model DIONEX ICS-2000.

It is used for the determination of the concentration of nitrates, nitrites, ammonium, sulfates, phosphates and others ions as Cl^- , Ca^{+2} , K^+ , Mg^{+2} .

3.2.2. Data analysis.

COD of an organic compound $C_nH_aO_b$ can be calculated on the basis of the chemical oxidation reaction assuming a complete oxidation:

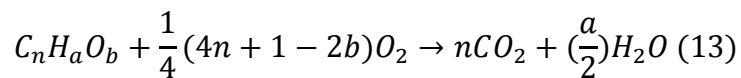

Eq. 14 shows that 1 mole of organic compound requires $\frac{1}{4}(4n + 1 - 2b)$ mole de O_2 in the oxidation. To express it in grams:

1 mole $O_2 = 32g$, so 1 g of demands $32 * \frac{1}{4}(4n + 1 - 2b)$ grams of O_2 . Considering $C_nH_aO_b$ in grams: $12n+a+16b$ g $C_nH_aO_b$ /mol $C_nH_aO_b$

$$COD_t = 8(4n + 1 - 2b) / (12n+a+16b) \text{ (gCOD/g}C_nH_aO_b\text{)} \quad (14)$$

CH_4 expected production can be estimated as:

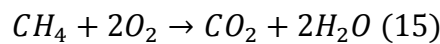

$$COD = 2 * \frac{M(O_2)}{M(CH_4)} = \frac{64g}{16g} = \frac{4gO_2}{gCH_4} \quad (16)$$

COD represents a suitable parameter to characterize the performance of anaerobic systems. The reason is no COD destruction in an anaerobic reactors, the COD is "re-arranged".

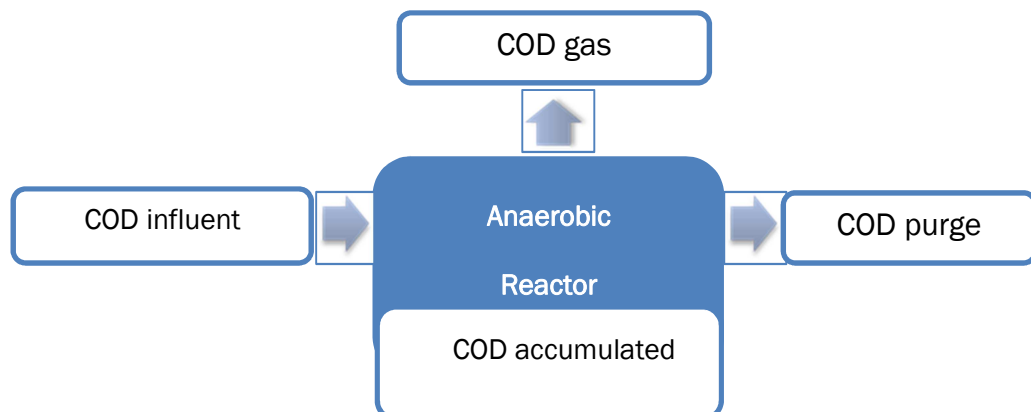

Figure 6 COD balance diagram

Mass balance without recirculation, expressed in KgO₂:

$$COD\ influent\ (KgO_2) = COD\ purge(KgO_2) + COD\ accumulated + COD\ gas\ (17)$$

COD removal:

Mass balances in order to know the production of CH₄ are made in duplicate. On the one hand, gas flowmeter (Ritter) and gas analyzer (XStream) registers the volume of gas produced and its composition (CH₄, O₂ and CO₂). Theoretical yield of the conversion of COD in methane is 0.9 in anaerobic digestion. Consequently, methane production is obtained by expressing it in grams of COD (4gO₂/gCH₄, eq.17) and dividing by inlet COD, all in accumulated values.

$$COD\ eliminated\ (KgO_2) = \frac{1}{0.9} COD\ production\ CH_4(KgO_2)\ (18)$$

On the other hand, it is characterized the COD of inlet and purged sludge of digester. Therefore, using mass balance (17), expressed in KgO₂:

$$COD\ eliminated = COD\ inlet - COD\ accumulated - COD\ purged\ (19)$$

COD accumulated (g/L) is equal to COD purged (g/L) considering ideal CSTR (continuous flow stirred reactor). Feeding and purging are quantified per jour. Therefore useful volume of the reactor is also known.

Graphics and results of COD eliminated will be expressed in function COD inlet, all in accumulated values.

Removal of VSS (Volatile Suspended Solids) is calculated in accordance with balance (19) expressed in VSS content, all terms in accumulated values.

Methane production:

The quantity of methane expressed in volume is determined by using universal gas law:

$$V = \frac{nRT}{P}\ (20)$$

Where V= volume occupied by the gas in L; n= moles of gas; R=universal gas law constant, 0,082057 atm·L/mole· K; T= temperature, K and P= absolute pressure, atm

Mesophilic conditions of the reactor are 35°C and the pressure is 1 atm. Due to eq. 18, volume occupied by one mole of CH₄ is 25,29L.

Because one mole of CH₄ requires 2 moles of O₂ (COD), eq. 16, which is equal to 64 g. Therefore, theoretically, the amount of CH₄ produced per gram of COD converted is equal to 0.40 L.

$$\frac{25,29 \text{ L CH}_4}{64 \text{ g}_{\text{mole CH}_4} \text{ COD}} = 0.40 \text{ L} \frac{\text{CH}_4}{\text{gCOD}} \quad (21)$$

As well as COD removal, methane production is characterized in duplicate: directly gas measure (flowmeter and gas analyzer) and COD characterization of feed and purge COD, using eq. 18.

Sludge Retention Time, in this step of the project where both reactors MAD and TAR work as a mesophilic anaerobic reactor with four recirculations between them, is calculated as they will be only one reactor.

$$SRT = \frac{V_{MAD-TAR}}{Q_{\text{purge}}} \quad (22)$$

3.3. Operational conditions.

In this phase of the project, both reactors MAD and TAR work in mesophilic anaerobic conditions at 35 °C. It is feeding with 14 liters of primary sludge produced in the two settling tanks, whose characteristics are gathered in Table 10.

Feeding and purging is doing at the same time once per day in automatic mode thanks to remote-control, excluding days when it is sampled (1-3 times per week depend on the program) where feeding is doing in manual mode with the automate interface. The Sludge Retention Time (SRT) of design is 20 days but both, SRT and feeding are not steady because of operational problems explained later. Characteristics of the resulting sludge and methane production are gathered in Table 10. Recirculation between MAD-TAR is made 4 times per day, 60 L/day at summary. This line was installed to exchange sludge between a MAD and TAR, necessary in next step of the project.

*Table 9 Operational conditions of MAD. *During steady period. Changes were performed because of start-up of settling tanks and disturbances in WWTP inlet.*

	MAD	TAR
Volume (L)	500	50
T (°C)	35	35
Inlet flow (L/d)	14*	60
Feed	Primary sludge	
SRT, d (average, standard deviation)*	19.8 ±1.8	

Table 10 Characteristics of sludge fed and digested. Biodegradation and methane production

Parameter	Primary sludge (inlet)			Anaerobic digested sludge (MAD)		
	Start-up	Steady period	Disturbances	Start-up	Steady period	Disturbances
pH	7,2-7,6			6,8-7,2		
TSS (g/L) (average± Standard deviation)	18,7± 5,2	20,5± 1,3	15,6± 6,9	13,0± 0,9	11,6± 0,4	8,4± 1,6
VSS (g/L)	15,3±4, 5	16,8±1,0	13,6±5,6	8,8±0, 5	8,3±0,4	6,0±1,2
VSS/TSS	0,82±0, 02	0,82±0,01	0,88±0,04	0,68± 0,02	0,72±0,01	0,71±0,02
COD total (g/L)	24,3±7, 0	27,7±3,2	20,1±7,6	15,4± 1,4	13,7±0,8	3,8±6,4
COD soluble (g/L)	0,8±0,3	0,7±0,1	0,8±0,3	0,4±0, 0	0,4±0,1	0,3±0,0
Soluble COD (%)	3	2	4	3	3	8
Ammonium (g- NH ₄ ⁺ /L)	-	0.06±0.01		-	0.38±0.13	
CH ₄ composition in gas outlet (%)				59.9	61.82	57.03
CO ₂ composition in gas outlet (%)				36.23	35.34	33.51
Methane	-	.	.	39,5	54,6	

production by COD analyzes (%)					
Methane production by gas quantification (%)				52,8	43,4
VSS removal (%)	-	-	-	53	60,3
COD removal by COD analyzes (%)	-	-	-	43,9	58,6
COD removal by gas quantification (%)				58,8	47,1

Percentage of COD removal in function of COD inlet, methane production (measure of Ritter) expressed in COD in function of COD inlet, VSS removal in function of VSS inlet, and all these in accumulated values.

Primary sludge produced in settling tanks has suffered several changes because the start-up on the one hand, and disturbances in the characteristics of the influent in WWTP on the other hand. Next table shows the implemented programs during the start-up of primary settling:

Table 11 Programs developed for primary decantation

Operation mode	First program	Second program	Third program	Fourth program
Period	6/02/2017-2/03/2017	6/03/2017-8/03/2017	9/03/2017-23/03/2017	23/03/2017-13/04/2017
Times of feed per day	1	2	1	1
Times of transfer per day	1	1	2	2
Times of emptying of decantation 1	0	0	0	1
Hours of decantation in first settling tank	24	15 hours (1° alimentation) and 9 hours (2° alimentation)	24 hours before first transfer and 12 hours before second transfer	24 hours before first transfer and 12 hours before second transfer
Hours of decantation in second settling tank	24	14 hours (1st alimentation) and 8 hours (2° alimentation)	24 hours before first transfer and 12 hours before second transfer	24 hours before first transfer and 12 hours before second transfer
TSS (g/L) intervals; (median; standard deviation)	8.1-23.09 (17.52 ; 4.4)	20.61-35.32 (27.96-10.4)	9.56-19.9 (14.33-3.9)	18.74-21.45 (19.86 ; 0.9)
VSS (g/L)	6.49-19.00 (14.83 ; 3.6)	17.03-30.04 (23.54; 9.2)	7.62-16.6 (11.80; 3.4)	15.18-17.43 (16.35 ; 0.7)
VSS/TSS (g/g)	0.76-0.91 (0.83 ; 0.03)	0.83-0.85 (0.83; 0.02)	0.80-0.83 (0.82; 0.01)	0.71-0.72 (0.71 ; 0)
COD total primary (g/L)	10.23-38.12 (22.02 ; 6.7)	14.27-45.87 (23.51 ; 13.5)	12.225-26.82 (22.12 ; 5.1)	23.91-28.75 (27.05 ; 1.4)
COD soluble (mg/L)	415.0-1255.5 (672.5 ; 220.0)	167-558 (368;210.4)	406-668 (623.5; 93.2)	462.5- 692.5 (638.5 ; 83.2)
COD total after digestion (g/L)	14.31-19.16 (15.59 ; 1.2)	14.06-14.27 (14.17 ; 0.2)	12.93-17.96 (14.0 ; 17.9)	12.23-14.56 (13.9 ; 0.8)
COD soluble after digestion (mg/L)	413.5-524 (468 ; 35.4)	379-403.5 (379 ; 14.1)	304-451.5 (377.5 ; 45.8)	300 - 525 (331 ; 77.9)

These changes of programs were developed with the objective of getting a suitable performance in automatic mode (avoiding blockages) and obtaining better conditions of primary sludge (high content of COD, MVS, appropriate ratios VSS/TSS).

Fourth program is called “steady program” because it is obtained an adequate reproducibility of the performance of both, MAD and settling tanks. However, inlet wastewater in the station suffered variations which also affected

the quality of the primary sludge: reduction of VSS, TSS and COD inlet, especially COD particulate matter. This period is called “disturbances”.

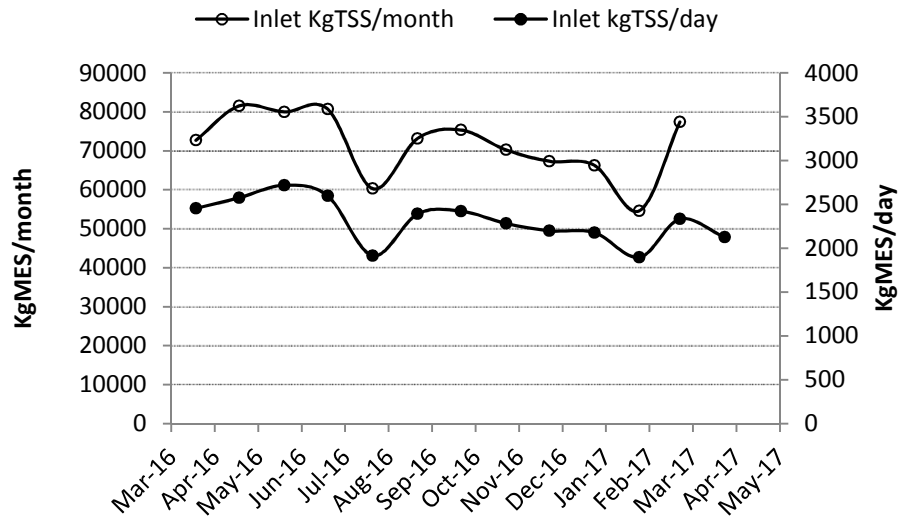

Figure 7 Inlet of the WWTP where SMS project is implanted. Values are given in KgTSS

This fact has been caused a dilution of the organic charge inside MAD and the production of methane has decreased, how next graphic shows:

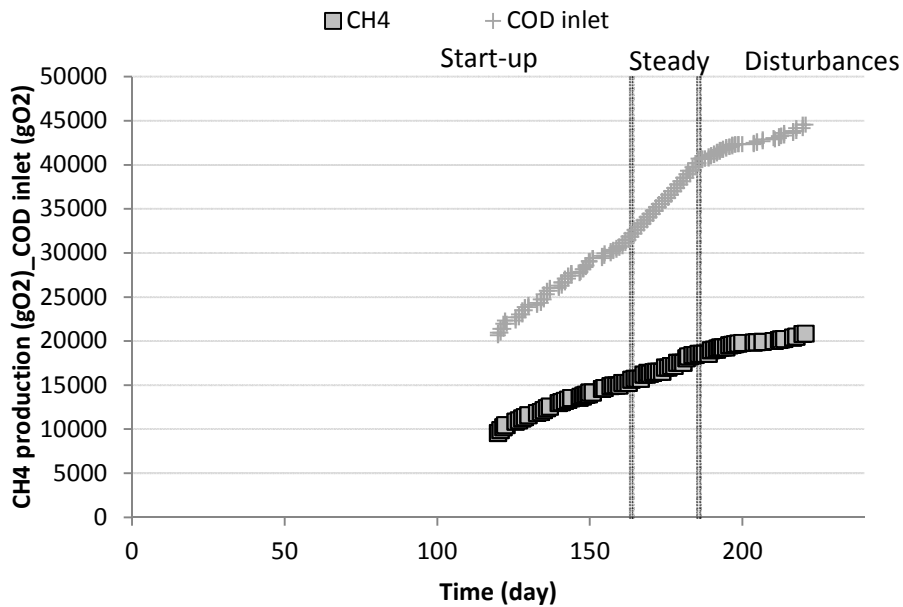

Figure 8 Evolution of methane production and COD inlet

3.4. Sample methods.

For the following of the relevant parameters, it is sampling once (steady period) or five times (start-up) per week.

In the figure 4 and 5, numbered spots indicate the place where a sampling is taking in the pilot plant. Afterwards physicochemical characterization is made in the laboratory.

- 1- Inlet of wastewater, which enters in the first settling tank, coming from the WWTP.
- 2- Outlet of the supernatant of the first settling tank, which goes to membrane bioreactor.
- 3- Manual valve for sampling the bottom of first settling tank. Not done frequently, because this sewage still has to improve the decantation in second settling.
- 4- Manual valve for sampling the bottom of second settling tank (feed of MAD-TAR). In optimal condition, at least 15 liters of primary sludge are obtained.
- 5- Sampling of gas contained in MAD.
- 6- Purge sampling.
- 7-

4. Results and discussion.

4.1. Performances of pilot coupling anaerobic mesophilic and aerobic thermophile digestion.

The characteristics of the primary sludge and digested sludge are given in Table 10, start-up of anaerobic reactor was developed during 116 days. First of all, inoculation is made with 150 L of secondary sludge and bovine manure where bacteria have difficulties for the consumption of all oxygen within MAD; consequently the conditions of the process are still aerobic (first 14 days).

Subsequently, 210 L of secondary sludge were fed and 146 L of gas within reactor were obtained. After 17 days, biogas composition started to stabilize.

Afterwards, a synthetic feed prepared in the laboratory was utilized. They are prepared with different compounds, more and more complex to train different bacterial populations: first it is introduced acetic acid diluted in water, followed by the addition of ground toilet paper, starch and yeast in order to get a more

complicated feeding and to make the hydrolytic, acidogenic and acetogenic bacteria work. The amount of acetic acid is gradually reduced in favor of more complex elements.

One suitable bacterial population was developed; MAD is feeding with primary sludge from other WWTP (day 86) because of the fact that primary settling tanks were not installed at this moment.

After 120 days, system of primary decantation started to have successfully performance and MAD was fed with the primary sludge from settling tanks due to programs described in Table 11.

Within 100 days of feeding with the sludge generated in our pilot plant, the total COD feeding was 23,623.8 g. The total COD concentration of these sludge ranges from 6.4 g/L to 45.9 g/L, the COD soluble ranges from 0.17 g/L to 1.7 g/L and ratio VSS/TSS is equal to 0.72. All the characteristics are gathered in Table 10 in function of the program and period of the process. These large variations in the range of COD have had as origin the adaptation to WWTP conditions and operational problems already explained in 3.3. Despite disturbances, ratio VSS/TSS has remained high; consequently biodegradability of primary sludge is appropriate.

Next figure shows graphically the changes suffered by the feed of MAD. First interval (separated by discontinuous lines) corresponds to the start-up of the settling tanks, second interval is the steady period and third one is period called *disturbances*.

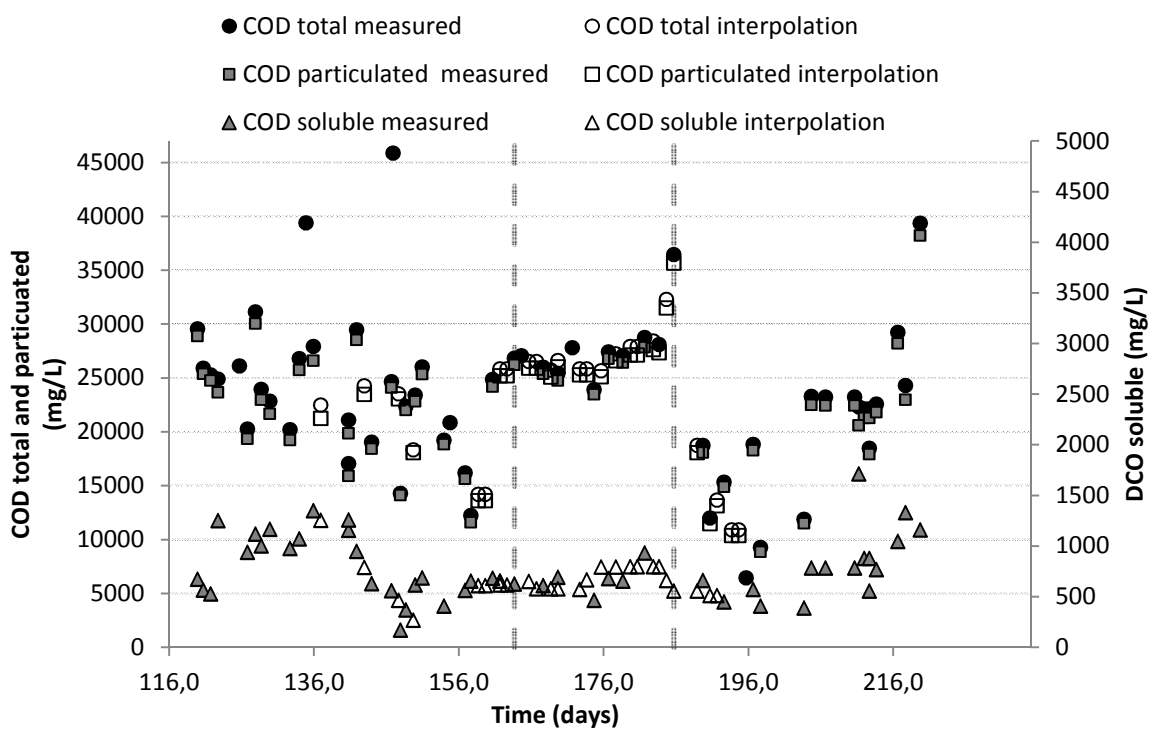

Figure 9 Total, soluble and particulated COD of MAD feeding

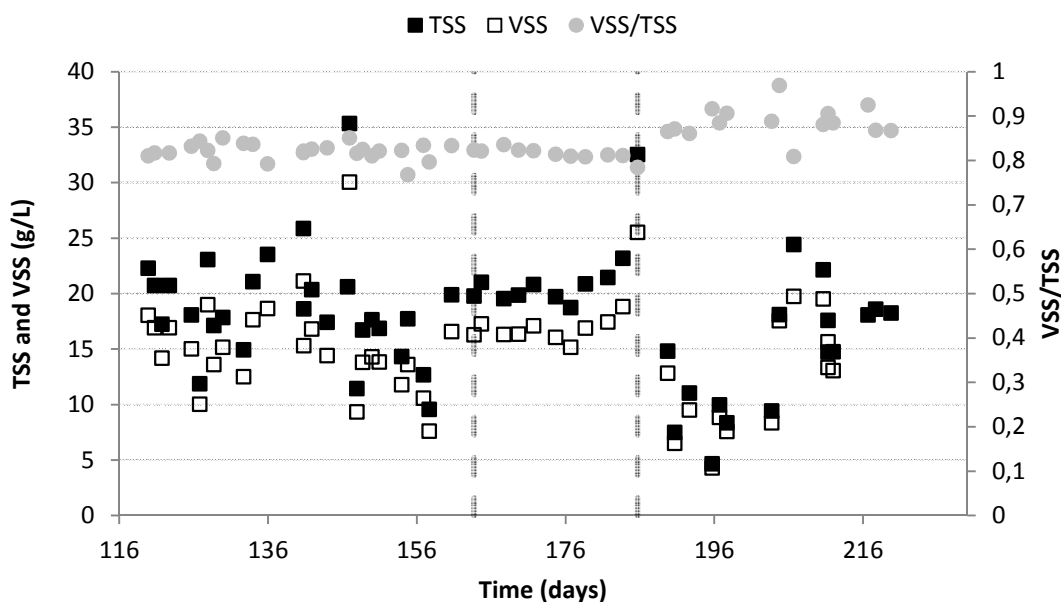

Figure 10 TSS, VSS and VSS/TSS ratio of MAD feeding

In steady period, ratio VSS/TSS is 0.71 ± 0.02 , according to bibliography Table 5, primary sludge obtained in the settling tanks is in the range of a medium size WWTP.

From steady period (day 163), removal of VSS was 60.0%, calculated in accordance with balance (19) expressed in VSS content, all terms in accumulated values.

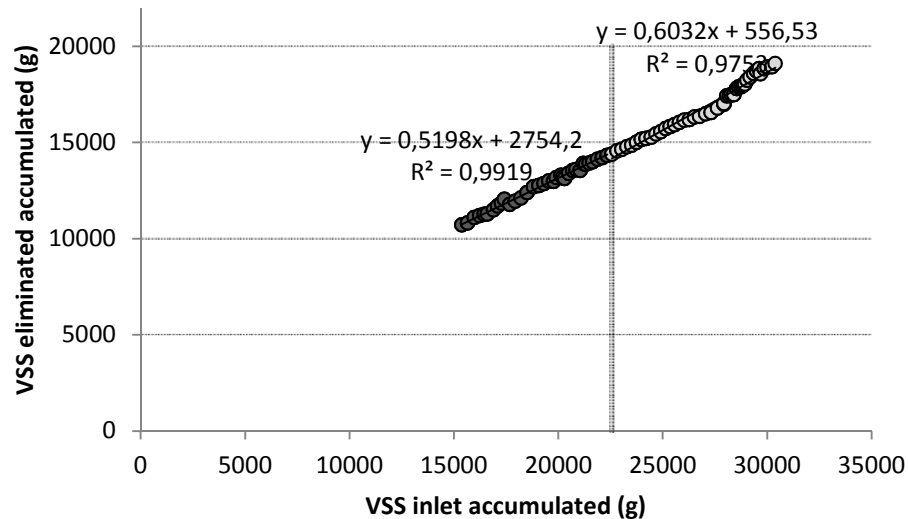

Figure 11 VSS removal. Grey line corresponds to the beginning of steady period.

The biodegradation efficiency for the system is measure in duplicate. On the one hand, gas flowmeter and gas analyzer let know the production of methane, and on the other hand, the COD of purge and feed is measured at the same moments of flowmeter values. In concordance with measures from gas flowmeter and gas analyses, total COD removal is 47.1 % (eq. 18) and cumulated COD degraded into methane is 43.3% ($4\text{gO}_2/\text{gCH}_4$, eq. 16) plotted versus total COD inlet, all in accumulated values. On the basis on COD characterization of feed and purge, removal of COD obtained is 58.6 % (balance 19) and methane yield is 54.6% (eq.18).

Following graphics of these values, it is presented the slope and determination coefficient, which indicates that the relationship found is not totally linear, especially in results of the characterization of purge/feed, partly for the last disturbances in primary sludge obtained which feeds the MAD.

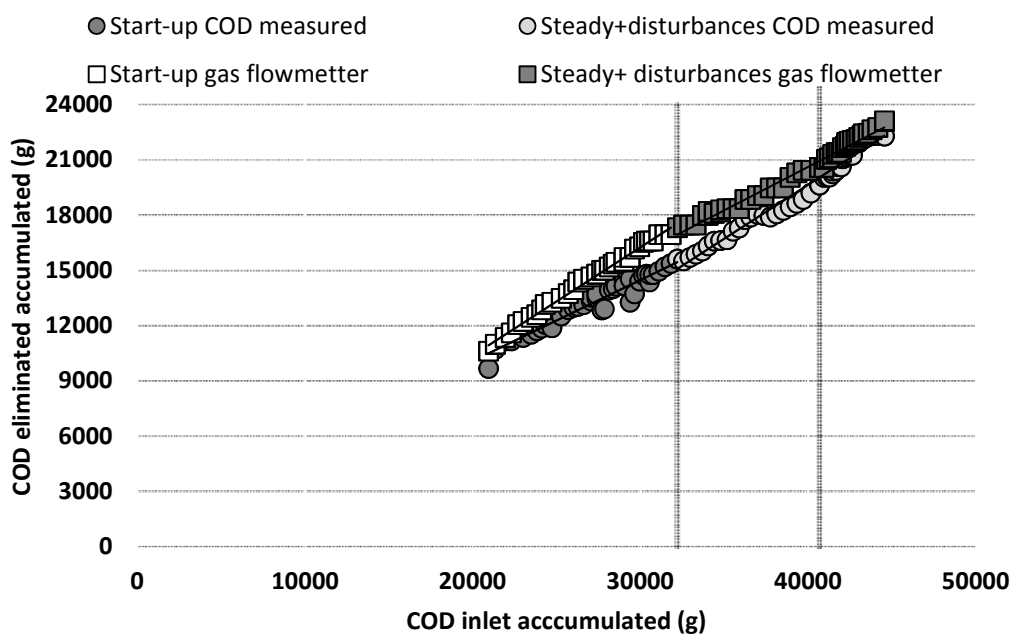

Figure 12 COD removal in duplicated: COD characterization and gas flowmeter and analyzer. First grey line corresponds to the beginning of steady period and second to disturbances in MAD feeding.

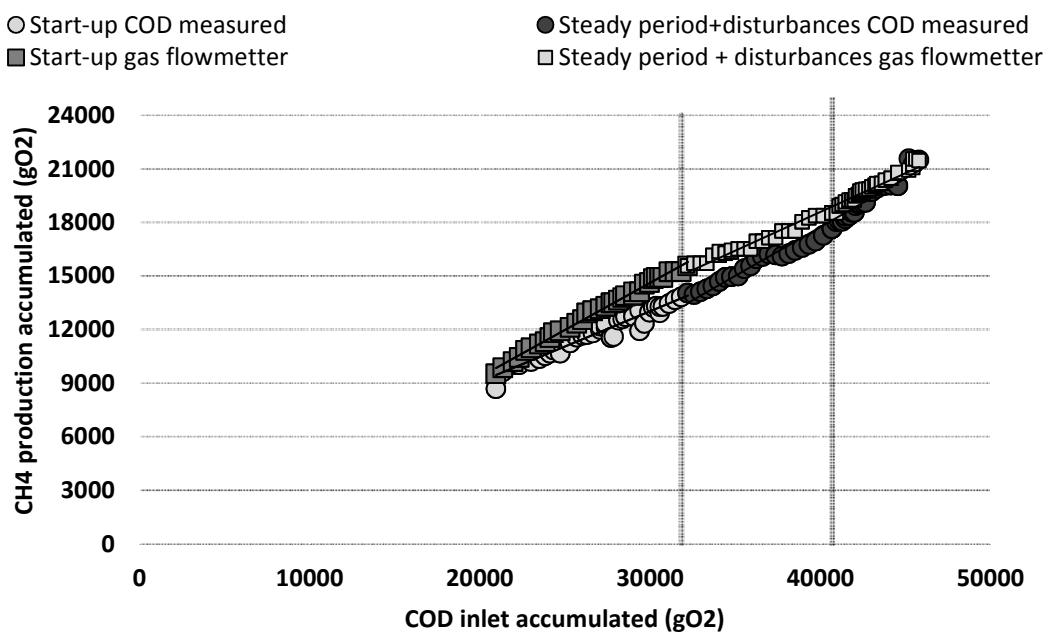

Figure 13 CH₄ production expressed in gO₂ versus COD inlet, all accumulated values, First grey line corresponds to the beginning of steady period and second to disturbances in MAD feeding.

Table 12 Slope and determination coefficient of total COD removal and CH4 yield

Parameter	Start-up (Slope; R ²)		Steady period and disturbances (Slope; R ²)	
	Mass balance of COD purge/feed	Gas flowmeter/analyzer	Mass balance of COD purge/feed	Gas flowmeter/analyzer
Total COD removal	0.439; 0.943	0.588; 0.993	0.586; 0.975	0.471; 0.983
CH4 yield	0.395; 0.944	0.528; 0.993	0.546; 0.973	0.440; 0.983

The yield of conversion from COD to biomass in anaerobic conditions is theoretically, 0.1, mainly the rest of COD is consumed for the production of methane. It is compared this elimination of COD (characterized by COD measured of inlet and purged, eq. 19) with the methane production measured by gas flowmeter and the gas analyzer. It is obtained 84.8% of methane over COD eliminated; all expressed in COD and accumulated values, **Error! No se encuentra el origen de la referencia.**

This error could be because of the gas flowmeter (Ritter). It does not give exactly values, if it is fed (purged) a volume of sludge from the MAD, the same volume of gas should have gone out (in) but it is not the case. Furthermore, the condensation of water vapor and rainwater usually caused blockages in the pipes at the beginning of the process.

Other cause to be taken in considering is the fluctuations of oxygen concentration inside the MAD-TAR, because the oxygen is toxic for methanogens (Zitomer, 1998). Majority increases of oxygen were caused by abrupt temperature changes or MAD purging. Cryostats installed are not be able to keep 35 °C in periods where there is a great difference of temperature between night and day. Purging decreases the volume of the reactor, so air from outside goes within the MAD. For avoiding this problem, first purge and feed were doing simultaneously (volume of reactor is almost constant, so air does not enter inside) and second a manual valve was installed, between outlet of reactor and gas flowmeter, which is only opened when measures are made.

The presence of ammonium ion in the sewage water could be an inhibitor of mechanization depends on the concentration. Both, NH₄⁺ concentration in primary sludge and purged are 0.06 and 0.38 g/L respectively, below of 1.5 g/L when ammonium ion could start to be an inhibitor according to the values found in bibliography, mentioned in 2.4.2.

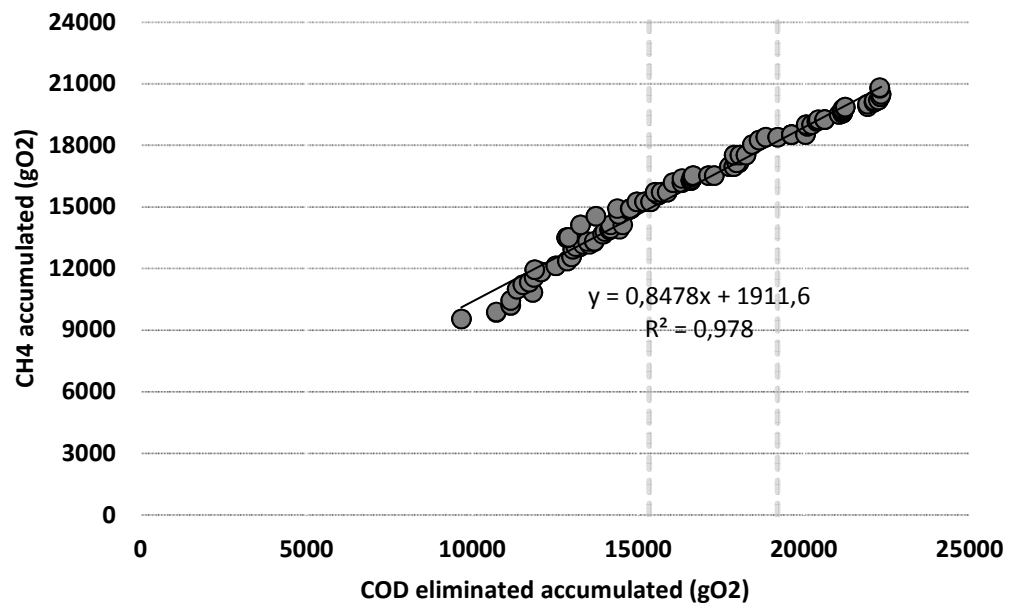

Figure 14 Yield of methane over COD eliminated

4.2. Conclusions.

Evaluation of the physicochemical performances of the coupling digesters, working in mesophilic conditions, represents a first step to evaluate afterwards MAD-TAR. In the same way of the evaluation of micropollutants degradation in MAD and MAD-TAR, not treated in this report.

Other important advantage is the saving of energy facing traditional aerobic treatments thanks to a coupling to an anaerobic treatment. It is reported that aerobic treatment in a conventional activated sludge process have yields about 50 % from COD converted; which requires further treatment and 1 kWh of aeration energy for the oxidation of 1 kg COD (HENZE et al. 2008).

Duplicate results obtained differ in 11.2% and 11.5 %, respectively total COD removal and CH₄ yield, being more optimistic the measured made by COD characterization of feed and purge, 54.6 % versus 43.4 % in methane yield and 58.6 % versus 47.1 % in total COD removal. All the values are in the range presented in Table 6 Characteristics and performance of digest sludge for MAD, in the same way that VSS removal, 60.3 %.

Getting a steady feed from the primary settling and a continuous automatic operation were the main challenges and difficulties of this evaluation, blocking a stable SRT and a constant organic load which could bring us closer to theoretical values and not-errors balance.

However, real WWTP has to face daily with this kind of problems: dilution, overload, excess of rainwater, variability of chemical components of the sewage inlet...For this reason, treating the same sewage as a conventional WWTP for a long period, with all variations associated, could give a real answer to implement a decentralized wastewater system.

5. Bibliography

- Anastassiades, M., Lehotay, S. J., Stajnbaher, D., & Schenck, F. J. (2003). Fast and easy multiresidue method employing acetonitrile extraction/partitioning and “dispersive solid-phase extraction” for the determination of pesticide residues in produce. *Journal of AOAC International*, 86(2), 412–431
- Cynthia Mitchel, Dena Fam & Kumi Abeysuriya. *Transitioning to sustainable sanitation: a transdisciplinary pilot project of urine diversion*. Institute for Sustainable Futures, University of Technology Sydney (2013)
- Dumas, C., S. Perez, E. Paul, and X. Lefebvre. 2010. “Combined Thermophilic Aerobic Process and Conventional Anaerobic Digestion: Effect on Sludge Biodegradation and Methane Production.” *Bioresource Technology* 101 (8): 2629–36. doi:10.1016/j.biortech.2009.10.065.
- Gikas, Petros, and George Tchobanoglous. 2009. “The Role of Satellite and Decentralized Strategies in Water Resources Management.” *Journal of Environmental Management* 90 (1): 144–52. doi:10.1016/j.jenvman.2007.08.016.
- Hamilton Booz Allen, Rocky Mountain Institute, & US EPA. Valuing decentralized wastewater technologies a catalog of benefits, costs, and economic analysis techniques. Rocky Mountain Institute, Snowmass, Colo (2004)
- HENZE, Mogens, Mark C.M. VAN LOOSDRECHT, George A. EKAMA, and Damir BRDJANOVIC. 2008. *Biological Wastewater Treatment, Principles, Modelling and Design*. First. London: IWA Publishing.
- Larsen, Tove A., Kai M Udert, and Judit Lienert. 2013. *Source Separation and Decentralization for Wastewater Management | IWA Publishing*. <http://www.iwapublishing.com/books/9781843393481/source-separation-and-decentralization-wastewater-management>.
- Lienert, J., Bürki, T. & Escher, B. I. Reducing micropollutants with source control: substance flow analysis of 212 pharmaceuticals in faeces and urine. *Water Sci. Technol. J. Int. Assoc. Water Pollut.* (2007).
- Mangone, Giancarlo. 2016. “Constructing Hybrid Infrastructure: Exploring the Potential Ecological, Social, and Economic Benefits of Integrating Municipal Infrastructure into Constructed Environments.” *Cities* 55 (June): 165–79. doi:10.1016/j.cities.2016.04.004.

- Moletta, R. *La methanisation*. (2011) Lavoisier, 2nd edition ISBN: 978-2-7430-1271-7
- R. Rajagopal, D.I. Massé, G. Singh. A critical review on inhibition of anaerobic digestion process by excess ammonia. *Bioresour. Technol.*, 143 (2013), pp. 632-641
- S. Martin Ruel, J.-M. Choubert. Occurrence and fate of relevant substances in wastewater treatment plants regarding Water Framework Directive and future legislations. CIRSEE, Suez Environnement (2012)
- TCHOBANOGLIOUS, George, BURTON, and STENSEL. 2004. *Wastewater Engineering, Treatment and Reuse*. Fourth Edition. New York: Metcalf & Eddy.
- Wendland C., Deegener S., Behrandt J., Toshev P. and Otterpohl R. (2007). Anaerobic digestion of blackwater from vacuum toilets and kitchen refused in a Continuous Stirred Reactor (CSRT).
- Zitomer, D.H., 1998. Stoichiometry of combined aerobic and methanogenic COD transformation. *Water Res.* 32 (3), 669–673.

Chapter B: Urine diversion toilet

6. Bibliographic synthesis: Urine diversion toilets.

6.1. Vacuum system in urine diversion toilets

Conventional centralized system of wastewater management collected higher dilution sewage in comparison with vacuum system, which utilize vacuum as the main agent of transport instead of water. These types of systems are widely used in planes and ships, but its implementation in residential communities is still limited.

Vacuum sewer system use differential air pressure to move the sewage. A central source of power to operate vacuum pumps is required to maintain vacuum on the collection system. The vacuum station has three major components: the collection tank, the vacuum pumps and the sewage pumps.

The vacuum pumps do not run continually, but rather in cycles. When this level is achieved, they turn off. As valves throughout the system open and admit atmospheric air, vacuum levels gradually drop. Sewage from the vacuum mains enters the collection tank and accumulates in the bottom part of the tank. When enough accumulates, the sewage pumps come on and pump the sewage out of the collection tank through a force main the ultimate point of disposal.

Using vacuum as transport method origins a less water consume and allow decreasing the diameter of pipes. This helps reduce the space needs, weight and cost considerations.

6.2. International experiences projects base on diversion urine toilets or decentralized wastewater management.

Urine and brownwater separation at GIZ main office building Eschborn, Germany (“Urine and Brownwater Separation at GTZ Main Office Building Eschborn, Germany - Case Studies” 2017).

This project carried out from 2005 to 2009 carried out a demonstration project in an urban office building. The scale of the project reached approx. 400 employees and visitors served by the urine separation system: 50 urine-diversion flush toilets (Roediger model), 23 waterless urinals (Keramag model), 10 m³ urine storage tank. Investment costs: EUR 125,800. Treatments investigated were:

Urine: Treatment by prolonged storage for direct application of urine to fields and precipitation of phosphorus and nitrogen from urine by the addition of

magnesium oxide. This process produces the crystal magnesium-ammonium-phosphate (MAP) or struvite. The system is air-tight.

Greywater: Storage tank as hydraulic buffer for the feed to the membrane bioreactor (volume 480 l) which submerged HUBER ultrafiltration (3.5 m² membrane surface) in a synthetic tank (volume 478 l). The membrane bioreactor works like the MBR of the brownwater treatment system. The flux rate of the membrane is 6 l/d*m² and the transmembrane pressure was adjusted to 60 mbar. The cleaning efficiency of COD elimination amounts 96%. The greywater inflow rate also produces permeate rate amounts 500-600 l/d. The chemical oxygen demand is reduced to 95-97%.

A New Approach to Urban Water Management: NoMIX toilet, Swiss Federal Institute of Aquatic Science and Technology, Dübendorf, Switzerland (Larsen, Lienert, 2007)

The “NoMix technology” concept is based on Roedinger diversion toilets: urine is collected in the front compartment of specially designed toilets and drained, with a little flushing water or even undiluted, into a local storage tank. The back compartment of these toilets operates on the same principle as conventional models; the waste matter collected is flushed into the sewers with water. Nutrients nitrogen and phosphorus are used to produce a fertilizer – or are removed by processes similar to those applied at wastewater treatment plants.

Separating urine from wastewater would offer various advantages: wastewater treatment plants could again be built on a smaller scale, and at the same time waterbodies could be more effectively protected from nitrogen and phosphorus inputs.

Sweden has approximately 700,000 on-site sanitation systems (Larsen et al, 2007). One of the case study to noticed is in municipality of Lund, in southern Sweden, has a large number of on-site sanitation system, where the blackwater has to be collected in sealed tanks. Since 2002 this fraction has been transported to slurry tanks at local farms and used as a liquid fertilizer for energy and fibre crops. Urea is added for hygiene control, utilizing ammonia sanitization. Low concentration of ammonia combined with storage pathogens, such as *Salmonella*, prior to reuse. After sanitation, the ammonia acts as a fertilizer for maize as an energy crop. The maize is fed into an anaerobic digester to produce an eco-labelled fertilizer and energy in the form of biogas. This type of system is developed by the municipal authority for decreasing eutrophication and cost of blackwater treatment.

Transitioning to sustainable sanitation, UTS Sustainable Sanitation Project, University of Sydney.

This project tries to investigate the issues associated with urine diversion toilets system. 5-7 urine diverting toilets were installed, Wostman EcoFlush was the first model chosen. After negative performances of this model of toilets, Dubbletten by BB Innovation & C) was installed. Main objectives of this project were:

- Track user experience and perceptions of the urine diversion toilets.
- Capture and learn from cleaners experiences with the maintenance of urine diversion toilets
- Capture and learn from the plumber's experiences with the installation process including compliance with applicable plumbing regulations.

6.3. Urine diversion toilets.

The urine diversion flush toilet is similar in external appearance to a conventional flush toilet. The toilet bowl has two sections so that the urine can be separated from the feces.

One of the objectives of diversion toilet is to collect the urine with less water, but a small amount of water is used to rinse the urine-collection bowl when the toilet is flushed.

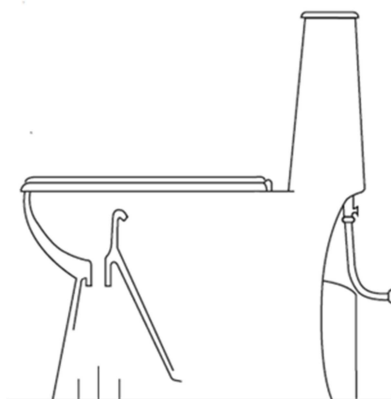

Figure 15 Urine diverting toilet (Source: Dubletten toilet)

Treatment and processing of the urine is carried out in different ways; urine flows into a storage tank for further use or processing: desiccation or struvite production (“Urine and Brownwater Separation at GTZ Main Office Building Eschborn, Germany - Case Studies” 2017) .

While the feces are flushed with water to be treated (onsite pre-treatment and treatment in septic tanks, biogas settlers, anaerobic baffled reactors; semi-decentralized treatment units).

The system requires dual plumbing, transport of both wastes happens via conventional gravity sewer system or vacuum sewer system.

On the one hand, conventional gravity system is the most common in residential homes; it works simply by the force of gravity on the water. When the flush button is pushed, the flush lever inside the tank raises up a valve, allowing water to take out through the flush opening and into the toilet bowl. The gravity force forces waste in the toilet bowl down into the toilet trap and into the house drain system.

On the other hand, vacuum system works by using differential air pressure to remove the sewage; differential pressure between atmosphere pressure and vacuum generated in a station becomes the driving forces to send off the sewage towards vacuum station. A central source of power to operate vacuum pumps is required to maintain vacuum (negative pressure) on the collection system. This system allows to reduce the quantity of water utilized.

For the discharge of urine, plastic pipes should be used to prevent corrosion. Small quantity of water used in vacuum system decrease the dilution of urine, consequently concentration of sulphate (SO_4^{2-}), responsible of the corrosion in pipes, enhanced.

In the presence of organics (electron donors) sulphate reducing bacteria (SRB) produce sulphide gas which escapes to the head space above the water in the sewer system. Sulphide oxidizing bacteria on the upper walls of the sewer oxidize with oxygen the sulphide to sulphuric acid. If pipe material is corrodible, sulphuric acid corrodes the crown of the sewer causing ultimate failure.

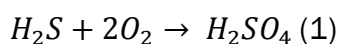

While the diversion and separate collection of the urine allows reusing all nutrients contained in it, urine diversion flush toilets can also reduce water consumption when compared to conventional toilets because people often to toilet to urinate only and the urine flush consumes only little water. If urine-soiled toilet paper is collected in a bin, rather than flushed away, water savings could be even greater (Muench et al. 2009).

Odor Control for the Urine Collection System

For the urine pipe, several types of odor seals are used by the toilet manufacturers, such as a valve (Roediger NoMix toilets) a urine/water seal (conventional U-bend for siphon effect) and a silicone valve (Dubbletten) designed to open when there is a pressure exerted from the bowl side (by urine) and locks if the pressure is greater below. Odor locks in the urine diversion toilet's urine pipe are required to prevent back flow of odor into the toilet room; but these are not necessary in the case of short urine pipe systems of up to 3 to 4 m. For the feces, odor is controlled by a water seal in a U-bend (just like for conventional cistern flush toilets siphon)



Figure 16 Odor seal of conventional cistern flush

Cleaning and maintenance

One of the main problems affecting division toilets is the build-up of urine scale, which blocks siphons and pipes. These blockages are caused by mineral precipitation. Enzymatic urea hydrolysis is the beginning of precipitation. Urease decomposes urea into ammonia and bicarbonate causing a pH increase

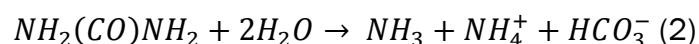

This increased of pH, promotes precipitation. Struvite ($\text{MgNH}_4\text{PO}_4 \cdot 6\text{H}_2\text{O}$), calcite (CaCO_3) and hydroxyapatite ($\text{Ca}_{10}(\text{PO}_4)_6(\text{OH})_2$) were identified in NoMIX toilets (Udert, Larsen, and Gujer 2003).

Dilution of urine is the main factor to determinate the precipitate composition. The higher is the dilution of urine, the lower is the precipitation. It happens if a solution is supersaturated with respect to a mineral. Thermodynamically, it is expressed as mineral's ion activity product (IAP) exceeds the solubility product (K_{sp})

To prevent the formation of precipitates, the urine drain can be regularly flushed with acid. Blockages can be removed using a strong acid or caustic soda, hot water or by mechanical means. Certain design measures can help to avoid blockages later on: pipes with the steepest possible slope (at least 2 – 5%), no tight bends or inaccessible sections, and a large diameter (65 – 110 mm). In waterfree urinals, precipitates are frequently collected in siphons, which have to be regularly replaced to avoid drainage problems (Larsen, Lienert, 2007)

When urea from urine is degraded (hydrolysed) by bacteria, the pH rises sharply, up to 9 or more. As a result of shifts in the buffer systems, the solubility product of various poorly soluble salts is exceeded, leading to crystallization. This is true in particular of struvite (magnesium ammonium phosphate, MAP) and various calcium phosphates. Ureolytic bacteria mainly grow in the pipes and are flushed into the collection tank. After only a few days, the urea is completely degraded. In undiluted urine, hydrolysis of only 8 % of the urea is sufficient to increase the pH to almost the maximum value, with 95 % of the possible precipitation being attained as a result. Less precipitation of salts per volume occurs with diluted than with undiluted urine. The least precipitation occurs when rain water is used for flushing, as this avoids the addition of either calcium or magnesium. Although the quantity of precipitates is one of the main factors giving rise to blockages, it is not the only one. Also critical are narrow diameters and prolonged residence of urine in pipes and siphons (Larsen et al, 2007)

6.3.1. Overview of separate toilets available in the market.

Dubblotten

Dubblotten is a Swedish company, established in 1991 operates within the wastewater treatment in domestic and municipal sector.

Gravity toilets by Dubblotten Company have two separate bowls for brownwater and urine collection. The urine compartment is flushed separately with an amount of water of 8 ml – 2 dl while faeces compartment uses 4 liters (source: dubblotten.nu). The urinal pipe is 2" in diameter with a sleeve around it 2.75".

For the purpose of saving water, it is necessary to dispose of urine-soiled paper in a bin, if not it is required flush more than one.



Figure 17 Urine diversion flush toilet by Dubbletten

The Dubbletten flushing mechanism provides a separate button-operated mechanism to rinse the urine bowl by a jet of water. The jet flows only as long as the button is pressed and discharges around 80 ml of water if the button is held down for 1 second. The urine bowl generally does not need to be rinsed after each use because it drains “clean”, and the toilet paper is flushed in the rear bowl.

Institute for Sustainable Futures, University of Sydney, has been worked in a researched project with Wostman and Dubbletten gravity toilets. They have reported several problems with both toilets (Mitchel et al, 2013). Concerning Dubbletten toilet, it has a spray for the urine bowl which, if used efficiently, meant a very low dilution of urine. The problem reported for the Institute is that after a period of time (about a month) the urine trap (a small rubber valve) stops functioning properly. Urine pools in the front bowl of the toilet, takes a very long time to drain and is socially unacceptable for users to come into a cubicle and see someone else's urine sitting in the bowl. The time that it takes the urine to drain is just too long for a busy office setting. While it was provided a small cleaning brush for users to help the drainage when it became blocked it was not an acceptable option for users in a public setting to clean the toilets so they can function properly.

Wostman

Wostman Ecology AB is a Swedish environmental engineering company that develops and manufactures eco- toilets and sanitation solutions. Toilet by Wostman works as a gravity toilet, but has a urine separating bowl in the front.

The double flush mechanism uses 0.3 and 2.5 litres (urine / feces). It is important that the water washes over the edge for maximum hygiene.

The flush volumes of EcoFlush are factory set at 2.5 / 0.3 liters. These volumes apply if the flush button is pressed distinctive for about 1 second. If buttons are pressed longer, more flushing water will be used. EcoFlush average of 0.8 liters of water per flush is calculated when using 5 small flushes + 1 large flush per day (source: *wostman.se*)



Figure 18 Urine diversion flush toilet by Wostman

Results and opinions reported from Institute for Sustainable Futures regarding Wostman gravity toilets show that Wostman toilets have the highest rate of installations globally but there were problems with the fact that there was a large volume of water being discharged with urine. The toilet's specifications were very different from how they functioned in practice. For example, the mean half flush volume was 1.29L but advertised as 0.2L and the mean full flush volume 5.11L but advertised as 2.5L. This would have been fine if the toilets actually flushed away paper and waste but they did not and this meant that users were flushing a number of times with large volume of water was being mixed with urine. The urine pipe was so small and unprotected so they had paper and feces regularly blocking the urine pipe. The toilet was also too short for tall users (“[D. FAM] Roediger NoMix Toilets - Good or Bad? And SANIRESCH Final Report (Urine Diversion Project with UD Flush Toilets and Treatment Reactors in Eschborn, Germany)”, 2011)

GUSTAVSBERG toilet

GUSTAVSBERG is a Swedish Company wholly owned subsidiary of the German Villeroy & Boch AG Group, manufacturers of bathroom furnishing solutions.

The flushing volume for urine compartment is 2 litres and for solid wastes 4 litres, 10% of each flushing is used to empty the urine siphon. This way sediment of urine and a blockage of the sewage pipes can be avoid (Source: *berger-biotechnik.com*)



Figure 19 Urine diversion flush GUSTAVSBERG toilet

Roediger toilet

The toilets by Roediger (model NoMix) have two separate bowls for urine and brownwater collection and two pipe connections for the separated wastewater fractions. The urine is collected undiluted (without flush water) by means of a valve located below the urinal bowl: the valve is opened when the user sits down.

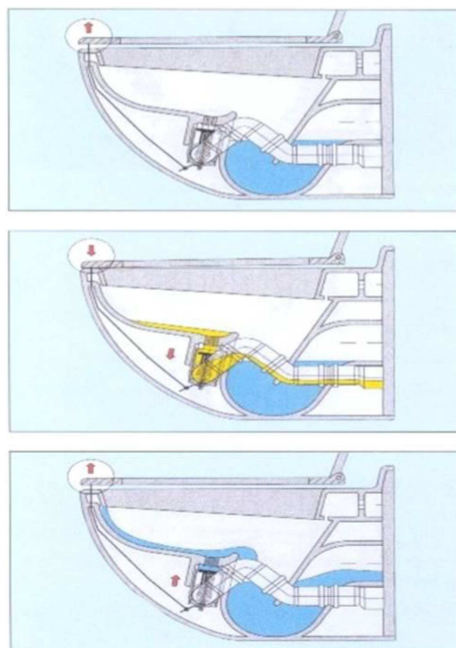

Figure 20 System of valve opening in Roediger toilet

The double flush mechanism uses 1-3 litres and 6 litres of water (urine / feces).

This technology was tested in the researched project SANIRESCH in Eschborn, Germany. It focuses on the development of treatment technologies and reuse practices, user acceptance, environmental and health issues (particularly with regards to micropollutants), legal and economic aspects, and the applicability of the system in industrialized, emerging and developing countries. The SANIRESCH project was designed to investigate the possibilities of a source-oriented wastewater separation and its reuse. For this purpose 50 Roediger toilets, urine-diversion flush toilets, and 23 waterless urinals of Keramag were installed at GIZ headquarters in Eschborn in 2007 ("Urine and Brownwater Separation at GTZ Main Office Building Eschborn, Germany - Case Studies" 2017).

Several conclusions obtained for previously cited project with Roediger toilets:

- Users of the separate toilets reported the 1-3 L flush to be ineffective. Mostly the 6 L flush is used and some users even flush two - three times.
- The majority of users liked the modern design of the toilets and appreciates the installation of the novel watersaving sanitation system in the GIZ main building. However, only 5% of the users say the cleanliness of the toilet is better compared to conventional toilets, and 51% say it is worse.
- The main problem with these toilets is that the urine pipe valve is susceptible to slimy struvite precipitations. This causes clogging of the valve, causing the urine to discharge through the brownwater pipe. Therefore, it is crucial to apply an adequate maintenance routine (Sälzer, Ochs, Ruster, 2012).
- Users should put toilet paper from urinating into a separate bin instead of trying to flush it down). At this stage, people often flush twice or even three times just to get rid of the toilet paper. (Forum SuSaNa, Elisabeth von Muenc, Roediger NoMix toilets - good or bad? And SANIRESCH final report).
- About 70% of all users indicated that they sometimes cannot flush the toilet as usual. More than 20% of the participants of the third survey had already experienced blocked toilets. 30% of the participants rated the usage as much worse in comparison to conventional toilets. About 70% of the users think that the cleanness is worse or much worse than of conventional toilets (Larsen, Lienert, 2007)



Figure 21 Roediger toilet

- Urine drain is only opened when the user is seated. Some users find it difficult to adopt the required sitting position. Women, for their part, are reluctant to sit on public toilets for hygiene-related reasons. Children in particular have problems targeting the right compartment, which increases the need for cleaning (Larsen, Lienert, 2007).
- They also noted that area of the feces is not enough big and feces ending up in the urine compartment. (Forum SuSaNa, Juergen Eichholz, Roediger NoMix toilets - good or bad? And SANIRESCH final report)

Toilet paper often gets stuck on the dividing wall between urine and feces outlet, so that the toilets have to be flushed more than once. Furthermore, it seems that the toilets get dirtier than conventional toilets due to the insufficient flushing. This causes more work for the cleaning staff (Larsen, Lienert, 2007).

Another minor problem is incrustations on the valves, which close the pipe leading to the urine tank. This problem mainly occurs with the tap water flushed toilets due to its content of calcium and magnesium. It can be solved by regular soaking and flushing with citric acid (20%). (Larsen, Lienert, 2007)

Evac Optima vacuum toilet

Evac is a Finnish Company which provides integrated waste, wastewater, and water management systems.

This toilet is not a gravity toilet; it uses a vacuum sewer system for the transport of wastes, urine and feces. It requires a dual piping system.

All flush mechanism is pneumatic, electrical connection are not required. Vacuum system of Evac toilet will be explained in detail in General description of the pilot-scale.

6.3.2. Summary and discussion of urine diversion toilets.

This table gathered the most implanted urine diversion toilets found, main characteristics, water consumption provided by manufacturers and problems reported from studied projects where toilets were installed.

Table 13 Summary of different urine diversion toilets and vacuum system. Values of prices and unities obtained from von Muench, 2011.

Toilet	Description	Water per flush	Problems reported
Wostman (EcoFlush model)	Gravity toilet <u>Indicative cost:</u> 346€ <u>Units sold:</u> 8,000 (until 2011) <u>Countries sold in:</u> 20 (main countries are Denmark, Finland and Norway).	Double flush mechanism uses 0.3 and 2.5 liters (urine/feces)	Real flush volume 1.3 L (urine) and 5 L (feces). Paper and feces regularly blocking the urine pipe. Paper passed full-flush paper but it often gets stuck on the dividing wall in half-flush test. Over 100% of urine dilution
Roediger (NoMIX model)	Gravity toilet. Urine collected undiluted by means of a valve opened by sitting on lid. <u>Indicative cost:</u> 780€ <u>Units sold:</u> approx. 420 toilets sold between 2001 and 2009 Countries sold in: Germany, Austria, Switzerland, Poland, Ireland, Luxembourg, Tunisia, Netherlands, India and USA	Double flush mechanism 1-3 and 6 liters (urine/feces)	One only flush of 1-3 L ineffective (users reported 2 or 3 flushes). People often flush twice or even three times just to get rid of the toilet paper. Users find it difficult to adopt the required sitting position. Area of the feces is not enough big and feces ending up in the urine compartment. Paper often gets stuck on the dividing wall.
Berger	Gravity toilet.	Double flush	Not reported problems

Biotechnik (GUSTAVSBERG model)	Urine diversion toilet. Urine pipe made from stainless steel (external to toilet bowl), acts also as odor seal: designed very flat, so that pipe is filled by 0.2 L of flush water, which is 10% of the urine flush <u>Indicative cost:</u> 665 €	mechanism 2 and 4 liters (urine/feces)	found. At 2011, Villeroy and Boch stopped producing this model.
BB Innovation & Co AB (Dubbletten)	Gravity toilets. Urine diversion toilet. <u>Indicative cost:</u> 523€ First installation was in 1992; Swedish patent granted in 1994 by supplier <u>Countries sold in:</u> Sweden, Denmark, Finland, Poland, Italy, Switzerland, Mexico, Australia, Czech Republic, Japan, Germany.	Double flush mechanism 8 ml – 2 dl and 4 liters (urine/feces)	The urine trap (a small rubber valve) stops functioning properly. Urine pools in the front bowl of the toilet, takes a very long time to drain. Passed paper half-flush test but not full-flush test. Toilet paper is flushed in rear bowl.
Evac (Optimum Vacuum 5)	Vacuum sewage system. Not diversion toilet. Sewage is pumped by a special type of helical screw pump. Pneumatic signal to the control mechanism.	Adjustable flush 0.8-1 liters.	Not reported problems found. Leaks in vacuum pipes cause the vacuum pump has to work continuously.

Despite of the fact that Wostman is the most sold toilet in Swedish, project “Transitioning to sustainable sanitation”, Sidney proved that the successfully at Swedish homes was not the same in Australian users in a public context. They reported that the design of separation wall is not very effective and fecal matter could contaminate the urine bowl easily and there were also several episodes of fecal material blocking the urine outlet. Experience with Dubbletten toilet was better, Australian users reported that the act of flushing the rear bowl satisfied

the habitual norm of flushing toilet after use, without generally needing to press the extra button.

Urine dilution in Dubbletten is not only much lower than Wostman toilet but its design of urine flushing optional could reduce the dilution to zero.

Gustavsber toilet model is not very interesting in our toilet model comparison because at present main industries stop producing it and it is not found a case study about this model.

On the contrary, Roediger model is well studied. Furthermore, it is the only one with a valve in urine pipe which is opened when users is sitting. This fact gets the model very attractive concerning urine dilution because when users press the button of water discharge the valve of urine pipe is closed, getting practically zero dilution. However, Ewag cases studies reported that users often flush twice or even three times to get rid of the toilet paper, reducing the saving of water and it is also reported an acceptance problem because users find difficult to adopt the required sitting position and it is not accepted in public spaces.

Evac toilet described is not a urine diversion toilet. Its presence here is because of the potential of a vacuum toilet in source separation. Evac vacuum toilet only needs 1 liter of water for removing the sewage, this fact presents a great advantage concerning saving water and urine dilution.

Wostman EcoFlush and Evac Optimum Vacuum toilet were chosen for pilot-scale plant of project SMS. Wostman toilet based on gravity sewage system is a referent in Swedish market; this will give us the opportunity to compare it with a new urine diversion toilet base on Evac vacuum technology and toilet model.

7. Materials and methods: urine diversion toilet pilot-scale

7.1. General description of the pilot-scale

A pilot-scaled formed by two separate toilets: Wostman EcoFlush and EVAC toilet modified are installed by technical personnel of the team along with JP COSTE enterprise according to next scheme:

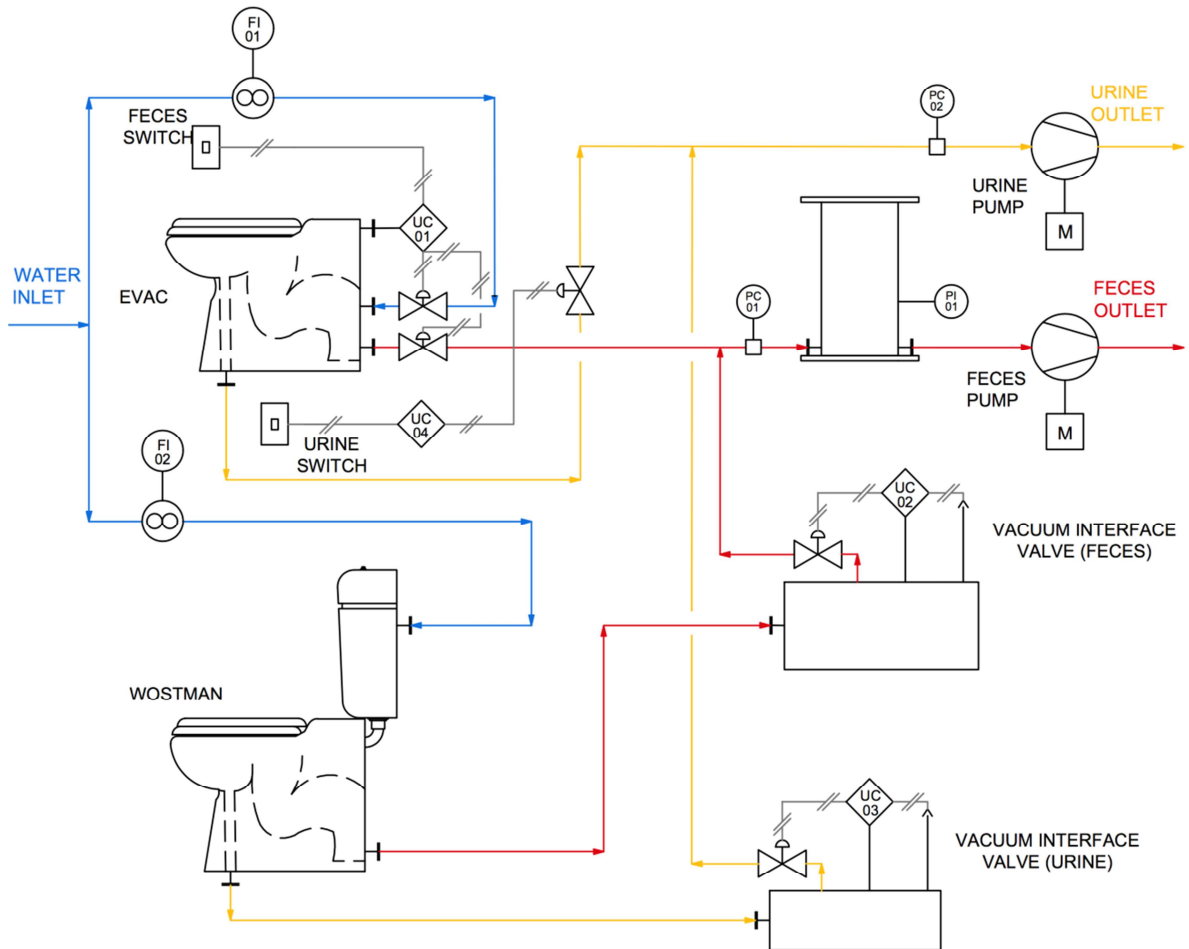

Figure 22 Pilot-scaled scheme of urine diversion toilets

Wostman Toilet works as a gravity toilet, both urine and feces. However EVAC toilet used a vacuum system which will be explained down below. Both toilets share two vacuum and macerating pumps EVAC V16, one for urine (upper pump) and other for the feces (bottom pump).

For adapt conventional gravity system of Wostman toilet to a vacuum sewage system, two different vacuum interface valves for urine and for feces are installed.

Two peristaltic pumps *Masterflex Model 77800-50* are used for the simulation of real human urine and feces. Each pump has a different diameter of pipe: 12 mm for feces and 6 mm for urine.

For measuring the quantity of water used per flush, two flowmeters are installed; one for Wostaman toilet and the other for Evac toilet.

EVAC toilet:

This toilet is a modification of EVAC Optimum Vacuum (Figure 23) toilet provided by EVAC Company. It uses a vacuum sewer system for the transport of wastes.



Figure 23 EVAC Optimum Vacuum toilet original

In the new design of EVAC Optimum toilet is installed a dual piping system for the transport of wastes: urine and feces. The initial prototype has two compartments separated by a wall (Figure 24).



Figure 24 Initial prototype, EVAC toilet

Vacuum is generated and sewage is pumped by a special type of helical screw pump. The centrifugal force causes sewage in the screw chamber to accumulate to the outer edge of the chamber whilst the air stays in the center of the screw. The screw moves sewage and air simultaneously, creating a vacuum which sucks new air and sewage into the chamber from the inlet. Before being sucked into the screw chamber the sewage is ground to a fine pulp by a macerator. (Source: marinevac.com)

The flush mechanism is pneumatic; when it is pushed the flush button sends a pneumatic signal to the control mechanism, which opens the discharge valve by letting water flow into the bowl through the flushing ring and discharge valve also allows vacuum from the piping system to enter the discharge valve diaphragm, connecting the bowl to the vacuum system. Air at atmospheric pressure then forces the sewage through the discharge valve and into the piping. The water valve opens at the same time and pressurized rinse water cleans the bowl. The whole operation is performed using vacuum, with no electrical connections required.

The control unit ensures that there is sufficient vacuum for flushing before allowing the flush to be performed, in order to prevent overflows or unflushed toilet bowls caused by a temporary loss of vacuum.

Quantity of water flush could be regulated using the control mechanism 5575500, with alternatives attachments that control flushing period called jet carries. Color, size and series number of available jet carriers are gathered in next table.

P/N 5775500 Control mechanism

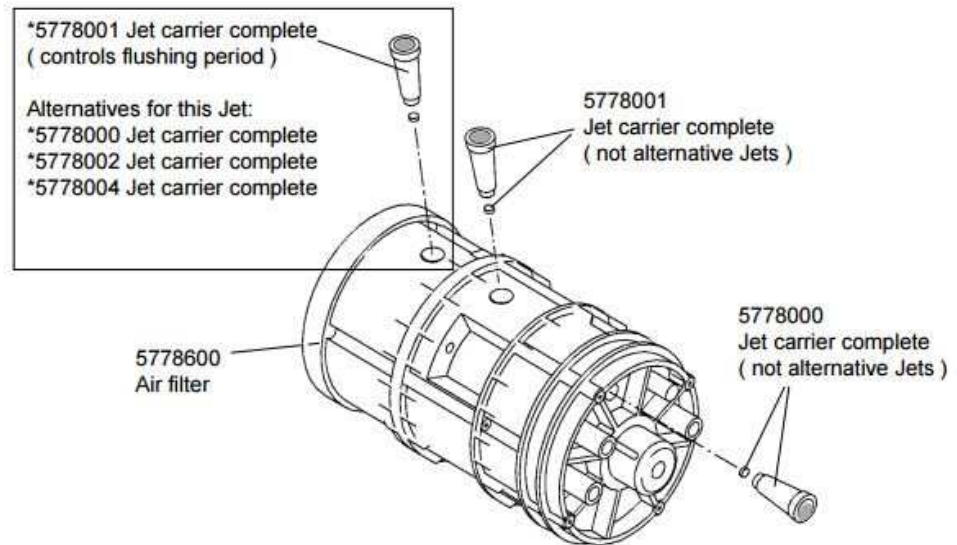

Figure 25 Flushing control mechanism of EVAC Vacuum Toilet (source: shop.marinevac.com)

Table 14 Jet carrier of flushing control mechanism

P/N	Color	Size	Effect
5778004	Yellow	0.20	Extra long flushing periods
5778000	White	0.30	Long flushing period
5778001	Blue	0.40	Normal flushing period
5778002	Red	0.50	Short flushing period

The characterization of the quantity of water per flush was made via test 2.- Pressing time of faces button is notice that the exchange of the two first jet carriers allow to get more quantity of water per flush. Next table shows the possible combinations of control attachments and the water discharged in the bowl (quantity of water is expressed in milliliters).

Table 15 Quantity of water per flush in function of jet carrier.

Sizes**	0.20	0.30	0.40
0.20	-*	1100	1000
0.30	1050	1000	900
0.40	1000	900	800

*Two jet carriers 5778004 are not available.

**Sizes in columns do reference to the attachments superior and files to the attachment inferior showed in Figure XZ

For getting this quantities of water is essential that flush bottom was not press more than 1 second.

Vacuum interface valves

Vacuum interface valves developed by Evac allow to connect gravity appliances to a vacuum system. Whole operation only used pneumatic system, not electrical connections are required.

It is also possible to adapt other sanitary fixtures of the bathroom as showers, washbasins, baths and urinals to a vacuum sewage system due to vacuum interface valve. That helps to eliminate the need to replace existing fittings in refurbishment projects.

This valves works in a similar way to EVAC vacuum toilet, when the level of the liquid in the gravity tank reaches 80 mm, the activator is activated. It transfers the operating vacuum to the plunger diaphragm, opening the discharge valve for three seconds. This operation is repeated every time that the liquid is in 80 mm of height in the tank.

Functioning of the vacuum interface valves is limited for sufficient operating vacuum (over -0.25 barg). If the pump system is not able to get this vacuum, the liquid rests in the tank.

Next table show characteristics of the two vacuum interface valves installed:

Table 16 Parameters of vacuum interface valves (source: evac.com).

Sewage	Model	Tank effective capacity	Connections (nominal DN&NPS)	Flow rate (-50 to -30kPa)
Urine	6545872 EVAC vacuum interface unit 5L, upwards	5L	40-50 mm - 1 1/2 to 2" (Vacuum) and 40 mm- 1 1/2" (gravity)	2.2-1.2 L/s
Feces	6548640 EVAC vacuum interface unit for gravity toilet	15 L	40 - 1 1/2 (Vacuum) and 100 mm- 4" (gravity)	2.2-1.2 L/s

Wostman Eco Flush toilet.

Wostman toilets have been described in 2.3.1 *Urine division toilets*. In the frame of SMS project, this toilet is combined with vacuum technology by using the already explained vacuum interface valves (VIVs).

To only rinse clean the urine requires very little water, the smartest way to flush is to focus the water in urine compartment and not flush the entire bowl with water. This is called “EcoFlush” by Wostman Company.

Wostman toilets have the highest number of installations globally, 8000 unities at 2011 (von Muench, 2011). For this reason, it will be a perfect reference which allows us to compare the design of a new urine diversion toilet.

7.2. Adaption to toilets legislation.

A testing protocol, which aims to check the performance requirements of the toilets of our research, has been developed. Tests are mainly focus on cleaning capacity, maintenance and user´s safety and satisfaction. They are described in detailed in ANNEX I: Toilet Performance Testing Protocol.

Reference Standards and Specifications used:

- ASME A112.19.2/CSA B45.1. Ceramic Plumbing Fixtures.
- AFNOR NF EN 997+A1. WC pans and WC suites with integral trap.
- NF EN 12109. Vacuum drainage systems inside buildings.
- ASME A112.19.14-2006 - Six-Liter Water Closets Equipped with a Dual Flushing Device.

Next table shows a summary of toilet performance testing protocol with the objectives pursued in each test, the performance advised by norms and a brief overview of the test performance.

Table 17 Summary of Toilet Performance Testing Protocol

Test (Norm)	Objective	Performance required	Brief performance overview
3.1. Toilet paper test (ASME A112.19.14-2006 section 3.2.4)	Evaluation of toilet paper removal. One of the most important factors in users acceptance	No paper shall remain in the well after each initial flush	Four (51 mm to 76 mm) balls of paper shall be dropped and shall be allowed to wet out completely. Within 5 sec after wetting occurs, the bowl shall be flushed.

3.2. Granule test (ASME A112.19.2/CSA B45.1 section 7.5)	Evaluation of solids removal in the bowl. It permits to note the unflushed areas	Not more than 5% of the original number shall be visible in the bowl after each flush.	Add 10 granules to the water in the bowl. Trip the actuator, hold for a maximum of 1 s
3.3. Surface wash test (ASME A112.19.2/CSA B45.1 section 7.6.)	Evaluation of the cleaning of the bowl and the capacity of the ring for wetting all the surface of bowl.	Ink line segments remaining on the flushing surface shall not exceed 51 mm when averaged over three test runs. No individual segment shall be longer than 13 mm.	Draw a continuous horizontal ink line around the circumference of the flushing surface, approximately 25 mm below the rim jets, with a dry erase marker. Trip the actuator, hold for a maximum of 1 s
3.4. Wash of the bowl (AFNOR NF EN 997+A1 section 6.2 and 6.17.10)	Evaluation of the cleaning of the bowl and noted unflushed or dry areas.	Arithmetic average of any unflushed area below the ring and above the surface of the trap shall be no greater than 50 cm ² after five flushing operations.	Moisten the complete inner surface of the WC pan. Sprinkle 20 g of sieved sawdust (2 mm) Operate the flushing device and record any area of unflushed surface.
3.5 Solids discharge and real performance (Own creation)	Simulation of a user real behavior	No rest of paper, artificial urine and feces shall remain in the well after each initial flush.	Pumping 200-250 ml of urine and 150 g of feces in the bowl. Stop the pumps and active the flushed device. Note the dirty areas after one flush

Nowadays, there is not a specific normative for diversion of urine vacuum toilets. It should be noticed that NF EN 997+A1 does not apply to flushing cisterns as separate appliances but this norm contains the standard performance requirements of close-coupled suites, one-piece and independent WC pans, which are most of the toilets of the market. One of the objectives of

the project is the development of a toilet which covers all the needs and requirements of the costumes. For this reason, the protocol developed in ANNEX I combines norms NF EN 997+A1 and ASME A112.19.2-2008 concerning performance and capacity of cleaning and NF EN 12109 relative to vacuum drainage systems inside buildings.

Tests of materials, finishes, structural integrity and seals complying with ASME A112.19.2-2008/CSA B45.1-08 chap.6, are not treated in this protocol, nor European Standards and French Standardization Association NF D 14-601-603 norms concerning to materials used in sanitary fixtures. These tests are object of toilet manufactures.

7.3. Evolution and improvements.

The main objectives of the pilot-scale toilets are:

- Normal performance of the toilet concerning cleaning of the bowl and elimination of the toilet paper.
- Environmental impact with low consumption of water per flush and minimum vacuum for saving energy and costs.
- A low dilution of the urine.

For achieving these goals, we have to obtain the best combination of the variables of bowl design (geometry, surface roughness, orientation of water in the ring) and operational variables (pressure difference in pumps of urine and feces, quantity of discharge of water). Test which evaluates maintenance and performance after several flush cycles will be evaluated in next stages of the project; they are not object of this rapport.

Toilet Performance Testing Protocol is detailed in Annex I and it is focus on requests of the users as cleaning capacity, maintenance, safety, comfort and aesthetic standards. However, a second testing protocol is detailed in Annex II with the objective of the characterization of pilot-scale plant concerning to dilution of urine, water saving and evaluation of the adequacy of pilot plant to a real decentralized system.

Table 18 Test for the evaluation of dilution of urine, water saving and pilot characterization

Test	Objective	Brief performance overview
1. Water consumption and dilution of urine	Analyzed of hydrodynamics of the wc. Characterize water consumption depend on the variation of control mechanism. Calculate the dilution of urine.	Measure the quantity of water at the outlet of the pumps for each jet carrier size and note the value of the flow meter. Pressure difference fix. Trip the actuator, hold for a maximum of 1 s
2. Influence of pressing time of faces button.	Measurer if the difference of quantity of water discharged in the bowl depends on pressing time of control mechanism. (Only Evac toilet)	Push the button during different times and note the value of the flow meter. Pressure difference fix. Size of jet carrier predefined 0.40, variation of the alternative jet carrier.
3. Influence of driving pump of urine with delay.	Evaluate of toilet paper removal by operating the pump of urine with different delays.	Develop 3.1. Toilet paper test ANNEX I but drive the pump of urine with different delay: at the same time that feces pump; one second after and two seconds after. Pressure difference and jet carrier fix.
4. Total removal of the paper: influence of water discharge.	Characterization of water discharge which gets the total elimination of the toilet paper in both compartments.	Develop 3.1. Toilet paper test ANNEX I for each variation of water discharge by changing the jet carrier of control mechanism and note the value of flowmeter for quantifying the discharge of water. Pressure difference fix.
5. Total removal of the paper: influence of feces pump.	Delimit pressure difference minimum in feces pump that makes the maximum elimination of the paper in feces compartment and separate area using pressure difference minimum (-0.50 barg).	Develop 3.1. Toilet paper test ANNEX I for each variation of pressure difference. Jet carrier fix for each cycle of test.
6. Total removal of the paper: influence of urine pump.	Delimit pressure difference minimum in urine pump that makes the maximum	Develop 3.1. Toilet paper test ANNEX I for each variation of pressure difference. Jet carrier fix for each cycle of

	elimination of the paper in the entire bowl with a pressure difference optimum obtained in test 4 Total removal of the paper: influence of feces pump.	test.
7. Real performance. Dilution of urine and feces.	Calculate the dilution of urine. Evaluate the cleaning of the bowl with pumps for simulating urine and feces.	Switch on pumps of feces for 20 seconds (100 g of feces) and urine for 15 seconds (200 ml urine). Measure the quantity of water at the outlet of the pumps and note the value of the flow meter. Pressure difference fix.

The pilot-scale toilets initially presented this scheme:

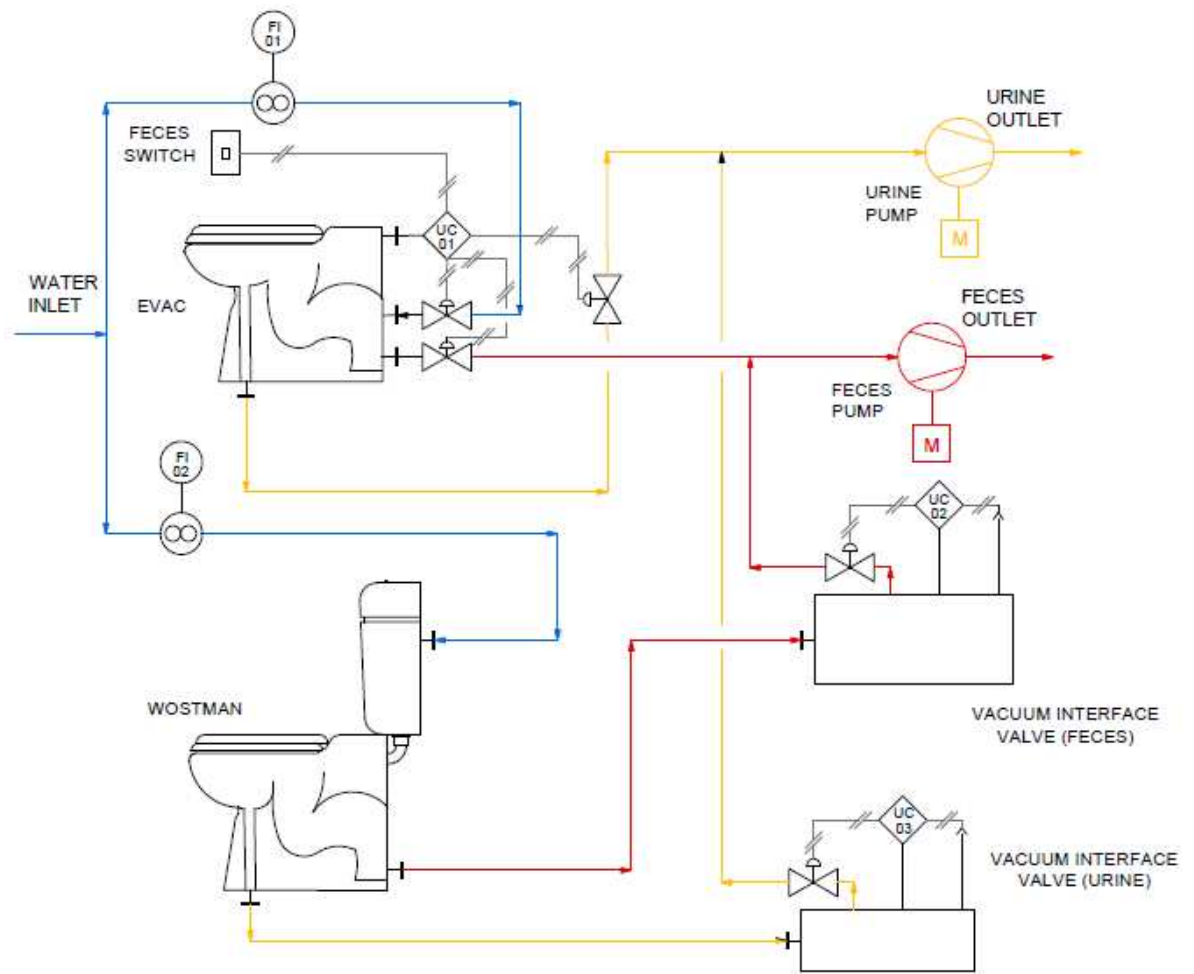

Figure 26 Scheme initial of pilot-scale toilet

In the first stage, general aspects of both toilets performance such as solid discharge, elimination of the paper and wash of the bowl following with test are evaluated through tests solids discharge and real performance, toilet paper test and granule test, described in ANNEX I : test 3.1, 3.2, 3.5.

As a result of an evaluation of the behavior of the initial pilot-scale, several changes was implemented: installation of a vacuum vessel and one pressure switch for each pump (changes in red) and an urine activator button (changes in blue) which allows to works pumps at different time. These changes are showed in next scheme and they will be detailed below.

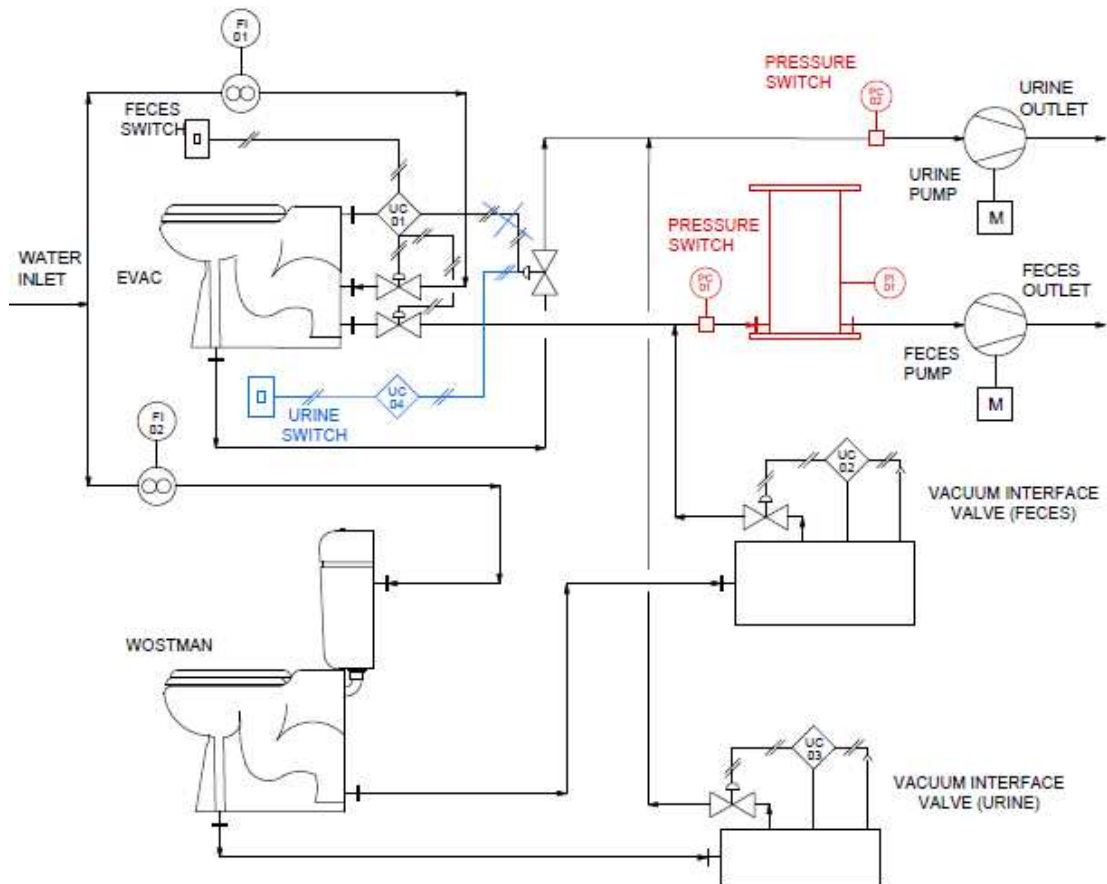

Figure 27 Final scheme of pilot-scale toilets with pointed out changes. Important changes in color

Next table gathered the evolution of the pilot-scale toilets, showing the objectives to be reached, the test utilized based on existing norms, results noted and the changes which were implemented for achieving these objectives.

Table 19 Evolution of toilet pilot and tests developed

Objective	Test	Result	Implemented change
Qualitative evaluation of pilot performance	3.5 - Solid discharge and real performance, ANNEX I.	Initial knowledge of pilot General lack of cleaning in the bowl	Geometry of urine compartment was modified, ¡Error! No se encuentra el origen de la referencia.
Toilet paper removal. Evaluation of user acceptance	3.1. Toilet paper test, ANNEX I (ASME A112.19.14-2006 section 3.2.4)	Toilet paper remained in the separation wall. Insufficient vacuum capacity for cleaning of the bowl and removal of paper (present in both compartments)	

Evaluation of new geometry change	3.1. Toilet paper test, ANNEX I. (ASME A112.19.14-2006 section 3.2.4)	Toilet was still remained in separation wall	Vacuum vessel and pressure switch was installed
Evaluation of implemented changes concerning to solids and paper removal	3.1. Toilet paper test (ASME A112.19.14-2006 section 3.2.4), 3.2- Granule test , ANNEX I (ASME A112.19.2/CSA B45.1 section 7.5)	Great improvement concerning to initial configuration of pilot. Paper only remains in feces compartment. Insufficient cleaning of the bowl. After two experiences, urine pipe of Wostman was blocked.	Geometry and slope of the urine compartment was softened. Actuator to work pumps at different times was installed.
Knowing optimal difference of time between two pumps	Test 3.1 - Toilet paper, ANNEX I (ASME A112.19.14-2006 section 3.2.4)	Acting urine pump after two seconds of feces pump allows a better paper removal There was not a completely elimination of paper	Metallic grid in urine compartment.
Evaluation of metallic grid. ¿Does paper slide in a properly way?	Test 3.1 - Toilet paper ANNEX I (ASME A112.19.14-2006 section 3.2.4)	Paper toilet has a worse removal. It is adhered to metallic grid and the adherence improved with wet paper.	-
Influence of the pressing time of discharge of water	Test 2. - Pressing time of faces button, Annex II	Huge importance in the control mechanism of water discharge.	
Water consumption and dilution of urine	Test 1.-Water consumption and dilution of urine, Annex II	Dilution of urine in EVAC prototype toilet is around 3% and 80% in Wostman toilet Pumps store and undetermined quantity of water. Diluted urine remains in the pipe, especially in elbows of installation.	

Qualitative evaluation with performance similar to test 3.5 – *Solid discharge and real performance* ANNEX I with both toilets reported that there was a general lack of cleaning in the bowl of each wc when they were flushed after urine and feces test. For carrying out this evaluation, dehydrated sludge (1000-1250 g/L) as feces emulator and colorant Orange II (CAS 633-96-5) as urine emulator were pumped in the two different peristaltic pump. As conclusion of this evaluation, it will be necessary to define a final protocol in order to check the improvements of the toilets performance. As initial comments, it should be increase the quantity of water per flush or improving the orientation of flush device in the ring, this point is especially important in Evac toilet but not in Wostman toilet thanks to the EcoFlush device.

Toilet paper test was not carry out with the same method as describe in Annex: test 3.1. Test was developed in a qualitative way to have a general idea of the possible defects of the system and it helped us to develop the protocol described in the Annex I and II. As result of these experiences, it was noticed two principal problems: toilet paper remained in the separation “walls” of the bowl of each toilet and insufficient vacuum capacity for eliminated all the paper and dirt.



Figure 28 Toilet paper problem in EVAC toilet



Figure 29 Toilet paper problem in Wostman toilet

For resolve the paper problems, geometry of EVAC bowl was modified how next imagen shows. It is changed the shape of urine compartment, this area was elevated using mastic as material. Main objective of this variation was the elimination of residual toilet paper in the wall of separation. Mastic will give the opportunity of trying different geometries of the bowl but it has a disadvantage in terms of roughness, paper toilet does not slip in the same way as sanitary porcelain.



Figure 30 EVAC toilet after change in the geometry of urine compartment

After this change, performance of EVAC toilet was still having problems of paper remaining and cleaning of the bowl.

For improving the capacity of the vacuum and try to solve the reported problems, a vacuum vessel was installed, seeing red elements of Figure 27. This

system permit to regulate the pressure of the urine and feces pumps with a pressure switch RT017-521566.

- Range of urine: -0.50 barg / -0.70 barg).
- Range of feces: -0.40 barg / -0.70 barg

Results of Test 3.1- *Toilet Paper test* and test 3.2- *Granule test* (detail of the performances of the test are explained in ANNEX I) are gathered in next tables. Each standard ball is represented by “x” and it is placed in the pertinent compartment of toilet bowl as Figure 31.

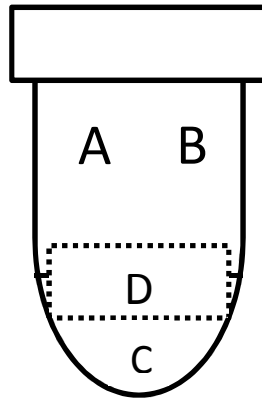

Figure 31 Compartments of the urine diversion toilet

Toilet paper test allows to compare de performance of both toilets in terms of paper removal. In Wostman toilet always remained paper when ball is dropped in urine compartment and feces compartment has too important problems. In four attempts developed, only one was successful. After two runs, urine pipe of Wostman toilet was blocked, reflecting futures possible problems of maintenance. By comparison, Evac toilet prototype has a perfect performance in feces compartment concerning paper removal but paper are still remained in separating wall.

Table 20 Test toilet paper after vacuum vessel installation in Wostman toilet

Test no.	Quadrant where paper was dropped (x=one ball of paper)		Replicate			
	A/B	C	1		2	
			A/B	C	A/B	C
1	xxxx		0 (remained 1 sheet)	-	0 (Remained 1 sheet)	-
2	xx	xx	0 (remained 1 sheet)	0 (remained 1 sheet)	1	0 (remained 1 sheet)

(0)=fail; (1)= success

Table 21 Test toilet paper after vacuum vessel installation in Evac toilet

Run no.	Quadrant where paper was dropped (x=one ball of paper)		Replicate					
	A/B	C	1		2		3	
			A/B	C	A/B	C	A/B	C
1	xxxx		1	-	1	1	1	-
2	xx	xx	1	0	1	1	1	0

(0)=fail; (1)= success

Granule test was performed only in EVAC toilet prototype because of the blockage of Wostman toilet in previous test. Granule test confirms solids removal in feces compartment has an acceptable performance but in urine compartment it is showed that water does not rinse all compartment and solids are not eliminated.

Table 22 Results of Granule Test in EVAC toilet

Run no	Initial number		Final number		%Remaining	
	AB	CD	AB	CD	AB	CD
1	10	0	0	0	0,00 %	0,00%
2	5	5	1	2	20,00 %	40,00%

Vacuum vessel and pressure switch improvements have already showed a considerably improvement of the Evac toilet performance with regard to initial behavior. It is also remarkable that EVAC toilet got a better performance than Wostman toilet.

According to these results; removal of the toilet paper and an adequate cleaning was still the first objective in order to get the acceptance of future users. It was noted that vacuum from urine and feces compartment dragged paper into both compartments at the same time, causing one end of the paper was to urine compartment and the other end was to feces compartment. For avoiding this problem, geometry and slope of the urine compartment in EVAC toilet was softened. At the same time, it was installed an actuator which permits to actioner pumps of urine and feces at different times, seeing changes in blue in Figure 27.

Test 3.1 – *Toilet paper test* ANNEX I was performed with the objective of analyze the influence of activating first the pump of feces and after few seconds, working the pump of urine. It should permit to remove all the paper in the feces department and the intermediate area, avoiding the problem of paper toilet in the separation area of the bowl.

Table 23 Results of Paper Test in EVAC toilet, urine actuator evaluation

Test no.	Quadrant where paper was dropped (x=one ball of paper)		Replicate					
	A/B	C	t= 0s		t=1s		t=2s	
			A/B	C	A/B	C	A/B	C
1	xxxx		1	1	1	1	1	1
2	xx	xx	1	0 (x)	1	0 (x)	0	1(x)
3	xx	xx	1	0 (x)	1	0 (xx)	0	1(x)
4	xx	xx	1	0 (xx)	1	0 (xx)	0	1(x)

(0)= fail; (1)= success (x)= 1 ball of paper remains (xx)= 2ball of paper remains

Table 23 shows that the best performance takes place when urine pump is powered after 2 seconds (Pressure difference of -0.70 barg in urine pump and -0.50 barg in feces pump; minimum quantity of water used).

A metallic grid was installed as Figure 32 shows, the objective was removal the toilet paper and to get paper slide throw the piping. Unfortunately, toilet paper was still remained in the toilet.



Figure 32 Metallic grid

How it was already describe in 6.3 *Urine diversion toilets*, it is necessary to find the properly dilution of urine which permits to reach the equilibrium between undiluted urine (better results in further treatments) and slightly dilution (preserve the precipitation in the pipes and avoid blockages).

For evaluating the dilution of urine in our toilets, test 1.-(*Water consumption and dilution of urine*) present in Annex II was developed.

Table 24 First test of water consumption and urine dilution

Size	Run no	Value of the flowmeter before flush (m3)	Value of the flowmeter after flush (m3)	Urine outlet (g)	Feces outlet (g)	Comments
0.20	1	0,44160	0,44260	19,34	557,6	Possible errors: Press the button more than a second. This can introduce more water than that regulated by the controller; water remains in the pipe; difference between pressing both buttons could be more than 2 seconds because of experimental errors
	2	0,44260	0,44355	1,35	731,1	
	3	0,44355	0,44600	28,41	827,6	
0.30	1	0,44745	0,44840	114,83	660,3	
	2	0,44840	0,44940	1,56	853,9	
	3	0,44940	0,45025	9,52	1068,5	
0.40	1	0,45025	0,45105	8,44	555	
	2	0,45105	0,45285	18,25	751,6	
	3	0,45285	0,45370	18,43	860,3	

Table 25 Analysis of results gathered

Size	R un no	Water discharge (ml)	Water outlet total (ml)	Dead volume (ml)
0.20	1	1000	576,94	423,06
	2	950	732,45	217,55
	3	2450	856,01	1593,99
0.30	1	950	775,13	174,87
	2	1000	855,46	144,54
	3	850	1078,02	-228,02

0.40	1	800	563,44	236,56
	2	1800	769,85	1030,15
	3	850	878,73	-28,73

First results showed that water discharge does not follow a logical order. Possible errors:

- Discharge of water button was pressed more than a second. This could introduce more water than that regulated by the controller.
- Water remains in the urine pipe because the discharging of water does not finish when pump of urine stopped. For this reason, it will be necessary to power the pump of urine several times after each experiment for avoiding residual water remains in the pipe and not disturb next experiment.
- Difference between pressing both buttons (urine and feces) could be more than 2 seconds because of experimental errors.

For checking if control mechanism of discharge of water works properly, it is realized test 2. – *Pressing time of faces button Annex II.*

Table 26 Results of test 2 .- Pressing time of faces button (2 seconds, minimum time of pressing and 3 seconds)

Size	Run no	Value of the flowmeter before flush (m3)	Value of the flowmeter after flush (m3)	Water discharge (ml)
0.20	1	0,462	0,463	1000
	2	0,463	0,464	1000
	3	0,464	0,46505	1050
0.30	1	0,46505	0,46595	900
	2	0,46595	0,46695	1000
	3	0,46695	0,4679	950
0.40	1	0,4728	0,4736	800
	2	0,4736	0,47435	750
	3	0,47435	0,4752	850
Pressing time of the bouton (s)	2			

Size	Run no	Value of the flowmeter before flush (m3)	Value of the flowmeter after flush (m3)	Water discharge (ml)
0.20	1	0,48045	0,48145	1000
	2	0,48145	0,48245	1000
	3	0,48245	0,48345	1000
0.30	1	0,4776	0,47855	950
	2	0,47855	0,47945	900
	3	0,47945	0,48045	1000
0.40	1	0,4752	0,476	800
	2	0,476	0,4768	800
	3	0,4768	0,4776	800

Size	Run no	Value of the flowmeter before flush (m3)	Value of the flowmeter after flush (m3)	Water discharge (ml)
0.20	1	0,459	0,46	1000
	2	0,46	0,461	1000
	3	0,461	0,462	1000
0.30	1	0,4562	0,45715	950
	2	0,45715	0,4581	950
	3	0,4581	0,459	900
0.40	1	0,45375	0,4546	850
	2	0,4546	0,4554	800
	3	0,4554	0,4562	800
Pressing time of the bouton (s)	Minimum			

Size	Run no	Value of the flowmeter before flush (m3)	Value of the flowmeter after flush (m3)	Water discharge (ml)
0.20	1	0,48345	0,48445	1000
	2	0,48445	0,48545	1000
	3	0,48545	0,48645	1000
0.30	1	0,48645	0,4874	950
	2	0,4874	0,4883	900
	3	0,4883	0,4893	1000
0.40	1	0,4893	0,4901	800
	2	0,4901	0,4909	800
	3	0,4909	0,49165	750
Pressing time of the bouton (s)	3			

Results of this test confirmed that the time of button pressing has a huge importance in the control mechanism of water discharge.

. Water discharged is calculated as the difference of the flowmeters values after and before of each flushing.

Manufactured note that second jet carrier is 0.40 without alternatives but experiences have proved that it is possible to change both jet carriers, obtaining discharge of water values of next table:

Table 27 Discharge of water in function of the control mechanism

Sizes**	0.20	0.30	0.40
0.20	-*	1100	1000
0.30	1050	1000	900
0.40	1000	900	800

*Two jet carriers 0.20 (5778004) are not available.

**Sizes in columns do reference to the attachments superior and files to the attachment inferior showed in Figure XZ

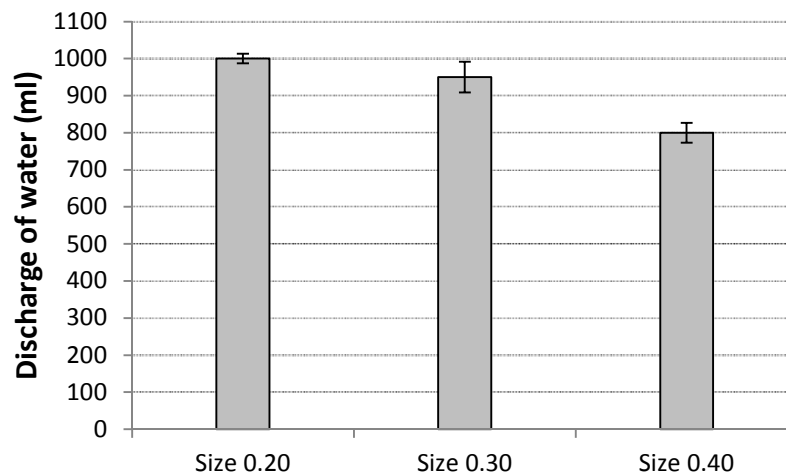

Figure 33 Discharge of water in function of the control mechanism for size 0.40 in bottom position (predefined by manufactured).

At this point, it is notice that this control mechanism for the discharge of water has not a big range of performance and the difference between the position of both jet carriers have almost non-existent. But it is very important not to press the button more than one second for having the discharge of water suitable for each jet carrier.

Test 1.-*Water consumption and dilution of urine* present in Annex II was developed again () but taking precautions of pressing the button for water discharge in a suitable way and waiting two seconds for powering the pump of urine.

For avoiding the problem of the water and urine which remains in urine pipe, *test 1* is developed twice:

a) Continuous: measure the quantity of water at the outlet of the pumps for each jet carrier size and note the value of the flow meter.

b) Discontinuous: measure the quantity of water at the outlet of the pumps for each jet carrier size and note the value of the flow meter. Operate the urine pump three times after each experience and measure the quantity of water which remained in the urine pipe.

a) Continuous

Table 28 Water consumption and urine dilution in continuous operation mode

ΔP urine	-0,7	ΔP feces	-0,4
------------------	------	------------------	------

	Bottom size	Upper size	Run no	Value of the flowmeter before flush (m3)	Value of the flowmeter after flush (m3)	Urine outlet (g)	Feces outlet (g)	Total inlet (water flush) (ml)	Total outlet (urine+feces) (ml)	% Water in compartment urine
12/06/2017	0.40	0.30	1	0,51065	0,5116	0,42	1242	950	1.242,42	0,04%
			2	0,5116	0,5125	0,42	959,2	900	959,62	0,05%
			3	0,5125	0,5134	0,16	834,4	900	834,56	0,02%
			4	0,5134	0,5143	0,67	907,6	900	908,27	0,07%
			5	0,5143	0,5152	0,34	779,3	900	779,64	0,04%
Total						2,01	4.722,50	4.550,00	4.724,51	0,04%

16/06/2017	0.40	0.30	1	0,52490	0,52585	43,31	1022	950	1.065,31	4,56%
			2	0,52585	0,52675	21,06	673,4	900	694,46	2,34%
			3	0,52675	0,52765	0,74	921,8	900	922,54	0,08%
Total						65,11	2.617,20	2.750,00	2.682,31	2,37%

ΔP urine	-0,7	ΔP feces	-0,4
------------------	------	------------------	------

	Bottom size	Upper size	Run no	Value of the flowmeter before flush (m3)	Value of the flowmeter after flush (m3)	Urine outlet (g)	Feces outlet (g)	Total inlet (water flush) (ml)	Total outlet (urine+feces) (ml)	% Water in compartment urine
16/06/2017	0.40	0.20	1	0,52190	0,52290	24,43	961	1000	985,43	2,4%
			2	0,52290	0,52390	2,90	682	1000	684,90	0,3%
			3	0,52390	0,52490	58,27	1110,6	1000	1.168,87	5,8%
Total						85,60	2.753,60	3.000,00	2.839,20	2,85%

ΔP urine	-0,7	ΔP feces	-0,4
------------------	------	------------------	------

	Bottom size	Upper size	Run no	Value of the flowmeter before flush (m3)	Value of the flowmeter after flush (m3)	Urine outlet (g)	Feces outlet (g)	Total inlet (water flush) (ml)	Total outlet (urine+feces) (ml)	% Water in compartment urine
16/06/2017	0.40	0.40	1	0,52765	0,52850	22,96	673,2	850	696,16	2,7%
			2	0,52850	0,52930	2,52	795,2	800	797,72	0,3%
			3	0,52930	0,53010	4,81	679,6	800	684,41	0,6%
Total						30,29	2.148,00	2.450,00	2.178,29	1,24%

b) Discontinuous

Table 29 Water consumption and urine dilution in discontinuous operation mode

	Size	Run no	Value of the flowmeter before flush (m3)	Value of the flowmeter after flush (m3)	Urine outlet (g)	Feces outlet (g)	Urine outlet after 3 flushes (g)	Total inlet (water flush + urine+feces) (ml)	Total outlet (urine+feces) (ml)	% Water in compartment urine
16/06/2017	0.40	1	0,53090	0,5317	1,07000	742,5	45,30	800	788,87	5,8%
		2	0,53170	0,5325	6,59000	747,3	7,01	800	760,90	1,7%
		3	0,53250	0,5333	0,70000	755,9	9,94	800	766,54	1,3%
Total					8,36	2.245,70	62,25	2.400,00	2.316,31	2,94%

16/06/2017	0.30	1	0,53330	0,5343	1,44000	1107,8	ND	1000	1.109,24	-
		2	0,53430	0,53515	0,15000	688,3	5,86	850	694,31	0,7%
		3	0,53515	0,5361	0,53000	954,1	91,18	950	1.045,81	9,7%
Total					2,12	2.750,20	97,04	2.800,00	6.693,11	1,48%

16/06/2017	0.20	1	0,53610	0,5371	0,39000	799,9	3,61	1000	803,90	0,4%
		2	0,53710	0,5381	0,21000	682,8	0,19	1000	683,20	0,0%
		3	0,53810	0,5391	1,55000	766,1	0,09	1000	767,74	0,2%
Total					2,15	2.248,80	3,89	3.000,00	10.688,07	0,06%

Next table gathered the results of previous test:

Table 30 Hydrodynamics performance in function of the control mechanism

Bottom size	Upper size	Total inlet water flush (ml)	Continuous		Discontinuous	
			Water in compartment urine after flush	Standard deviation	Water in compartment urine after flush	Standard deviation
0.40	0.40	800	2,13%	1,30%	3,05%	2,48%
0.40	0.30	950	0,92%	1,68%	1,48%	6,33%
0.40	0.20	1000	2,85%	2,79%	0,06%	0,18%

Pumps of urine and feces store some water in each experiment. To solve this inconvenient and close the mass balance, the percentage of water which goes out in urine compartment is calculated as division of sum of the urine outlet in each experiment and the total water discharge in the three repetitions.

7.4. Comparison of EVAC prototype and Wostman EcoFlush.

One of the objectives is to compare the performance of Wostman toilet (currently in the market) with the design of vacuum toilet based on EVAC technology. Test 6 – *Real performance. Dilution of urine and feces* Annex II shows that the dilution of urine in Wostman toilet is around 80% and Evac toilet around 3% (Table 32), fact which promote better results in following treatments of urine.

Table 31 Test 6 – *Real performance. Dilution of urine and feces in Wostman toilet*

Run no	Value of the flowmeter before flush (m3)	Value of the flowmeter after flush (m3)	Urine outlet (g)	Feces outlet (g)	Urine inlet (g)	Water discharge inlet (ml)	Total inlet (water flush + urine) (ml)	Total outlet (urine+feces) (ml)	% Water in urine outlet
1	0,92710	0,9329	955,8	4544,6	no	5800	5800	5.500,40	
2	0,93290	0,9387	934,5	4351,9	240	5800	6040	5.286,40	74,32%
3	0,93870	0,944	1084,5	4440,5	240	5300	5540	5.525,00	77,87%
Total			2019,0	13337	480	16900	17380	16.311,80	76,23%

Table 32 Dilution of urine in function of toilet model.

Model	Discharge of water	Total inlet water flush (ml)	Dilution of urine	Standard deviation
EVAC	Size 0.40/0.20	1000	3,30%	11,75%
WOSTMAN	Total	5800	79,40%	2,18%

7.5. Evaluation of pilot-scale performance

Other parameter which could affect mass balance is the remaining of urine/water in the pipe because of an enough vacuum or bad system configuration (i.e. elbows connection 90°).

For its evaluation, two tests were developed:

- Introduce a known quantity of water directly in urine pipe and operate only urine pump. Make the measure of the water outlet.

$$\text{Error of mass balance} = \frac{\text{Water inlet} - \text{Water outlet}}{\text{Water inlet}}$$

- Introduce and measure water for fill all the pipe of urine. Operate only urine pump once, make the measure of the water outlet and fill again the pipe. Do it for different pressures.

$$\text{Error of mass balance} = \frac{\text{1st water inlet} - \text{2nd water inlet} - \text{Water outlet}}{\text{Water inlet}}$$

First test shows after five repetitions that the mass balance does not close, neither each experience (errors 3-55%) nor total mass balance of the five experiences (error 68%).

Table 33 Results test recovery a known quantity of water in urine pipe.

Run no.	1	2	3	4	5	Total
V0 (ml)	255,70	255,80	254,40	259,80	252,60	
1	0,00	28,30	88,60	64,80	108,30	
2	0,00	17,90	34,70	15,40	70,50	
3	0,00	50,90	25,90	27,90	34,20	
4	0,00	21,10	45,80	8,10	2,20	
5		30,10	5,20	1,40	45,50	
6		32,10	0,30	0,00	0,60	
7		0,30			0,00	
8		0,10				
Total outlet	0,00	180,80	200,50	117,60	261,30	760,20
Dead volume	255,70	75,00	53,90	142,20	-8,70	518,10
Error mass balance	-	29,32%	21,19%	54,73%	-3,44%	68,15%

Second test shows errors of 2-8% in mass balance for -0.70 barg in urine pipe and errors of 5-43 % for -0.50 barg. Button for -0.50 barg had to be press twice for recovery a appreciate quantity of water.

Table 34 Results influence of pipes system configuration, elbows (-0.70 barg urine pump)

Run no.	V initial (ml)	Urine outlet (ml)	Water pipe (ml)	Error mass balance
1	597,6	96	516,3	-2,5%
2	599,5	140	505,4	-7,7%
3	581	76,6	468,5	6,2%
4	560,2	190,2	551,1	-32,3%
5	632	200	443,7	-1,9%
Total	2970,3	702,8	2485	-7,3%

Table 35 Results influence of pipes system configuration, elbows (-0.50 barg urine pump)

Run no.	V0	Urine outlet	Water pipe	Error mass balance
1	545,7	241,1	515,8	-38,7%
2	545,1	260,4	520,5	-43,3%
3	540,4	137,5	482,2	-14,7%
4	536,1	94,3	470,2	-5,3%

Total	2167,3	733,3	1988,7	-25,6%
--------------	--------	-------	--------	--------

These test let us know that for an appropriate performance of the urine outlet is necessary a suitable pressure.

Last test also allowed to know that with -0.40 barg system is not operating and with -0.80 barg pump needs a lot of time for generate the vacuum and the temperature of the pump increases too much.

8. Conclusions and discussion.

From all previous tests, it is obtained following remarks:

- Wostman toilet has presented one serious blockage in urine pipe after few experiences. It will probably induce problems of acceptability and maintenance.-Discharge of water in Wostman toilets is less propitious than Evac toilet concerning dilution of urine: 80% Wostman in front of 3% Evac modified toilet.
- Pilot-scale in the laboratory presents some inconvenient of performance concerning to water storage in the pumps and pipe system configuration (i.e. elbows 90°) which disturb mass balance.
- Concerning results of test 3.1, 3.5, 3.2 Annex I and Test 1 in Annex II, paper toilet always remains in urine compartment and discharge of water does not clean completely all the bowl, rest of urine and feces left.
- Vacuum of urine pipe has a local performance and it is only removed the toilet paper next to the pipe.
- At present, vacuum of feces compartment is enough for total elimination of toilet paper in that part.
- Geometry of the bowl does not promote the elimination of paper.

Next steps involve:

- Evaluation of the influence of paper toilet in following treatments of urine.
- Increasing water discharge and/or improving its orientation for promoting the total paper elimination.
- Improving the surface finished of the bowl to approach the pilot-scale to a real performance.

9. Bibliography

AFNOR.WC pans and WC suites with integral trap.NF EN 997+A1.La Plaine Saint-Denis: AFNOR 2015

ASME A112.19.2/CSA B45.1. Ceramic Plumbing Fixtures. The American Society of Mechanical Engineers. New York. ASME 2008

ASME A112.19.14-2006 - Six-Liter Water Closets Equipped with a Dual Flushing Device. The American Society of Mechanical Engineers. New York. ASME 2006

Cynthia Mitchel, Dena Fam & Kumi Abey Suriya 2013.*Transitioning to sustainable sanitation: a transdisciplinary pilot project of urine diversion*. Institute for Sustainable Futures, University of Technology Sydney.

Winker M., Saadoun, A., (2011): *Case study of SuSana projects: Urine and brownwater separation at GIZ main office building*, Echborn, Germany.

von Münch, E., Winker, M. (2011). *Technology review of urine diversion components - Overview on urine diversion components such as waterless urinals, urine diversion toilets, urine storage and reuse systems*. Gesellschaft für Internationale Zusammenarbeit (GIZ) GmbH

Larsen, Tove A., Alcer, A. (2009). *Source Separation: Will we see a paradigm shift in Wastewater Handling?* Eawag, Swiss Federal Institute of Aquatic Science and Technology, Dübendorf.

Lienert J., Larsen T.A. (2006): *Considering user attitude in early development of environmentally-friendly technology: A case study of NoMix toilets*. Environmental Science & Technology 40, 4838–4844.

Lienert J., (2007): *C'est une bonne idée, mais personne n'en veut!*. Eawag, Swiss Federal Institute of Aquatic Science and Technology, Dübendorf. Switzerland

Larsen, Tove A. (2007): *Ce que la Chine savait depuis longtemps*. Eawag, Swiss Federal Institute of Aquatic Science and Technology, Dübendorf. Switzerland

Sälzer, H., Ochs, T., Ruster C., (2012): *Project component: Sanitary in-house Installations*. Research Project Sanitary Recycling (SANIRESCH). Eschborn, Germany

Romich, M., Schiele, L., Wortmann, C. (2012): *Project component: Acceptance*. Research Project Sanitary Recycling (SANIRESCH). Eschborn, Germany

Udert, K. (2007). *NoMix: tout commence dans la sale de bain*. Eawag, Swiss Federal Institute of Aquatic Science and Technology, Dübendorf. Switzerland

Larsen, T. A., Lienert, J. (2007) *Novaquatis final report. NoMix – A new approach to urban water management*. Eawag, 8600 Dübendorf, Switzerland

Toilets Models:

BERGER BIOTECHNIK GmbH: The GUSTAVSBERG Separation Toilet. 2006 Germany. Download: <http://www.berger-biotechnik.de>

Dubblotten: Eco-friendly toilet and sewage systems. Download: <http://www.rosiesnaturalway.com>

Evac: Economical vacuum toilet. Finland. Download: <https://evac.com/solutions/vacuumcollection/evacoptima3/>

Evac: Vacuum interface valves. Finland. Download: <https://evac.com/solutions/vacuumcollection/viv/>

Evac: catalogue. Finland. Download: <http://shop.marinevac.com/download/EVACcatalogue2016.pdf>

Wostman: EcoFlush Brochure. Sweden. Download: <http://www.wostman.se/support-1>

Wostman: EcoFlush manual. Download: <http://www.wostman.se/support-1>

Annex A- I: PFDs

Process flow diagrams (PFD) are attached:

- PFD-001: PRIMARY DECANTATION
- PFD-002: MAD-TAR

Annex B- I:

Process flow diagrams (PFD) are attached:

- PFD-001: INITIAL SCHEME
- PFD-002: VACUUM VESSELS MODIFICATION
- PFD-003: URINE SWITCH INSTALLED

Annex B- II: Toilet Performance Testing Protocol

Annex B- III: Experiences for evaluating the performance of pilot-scale: water consumption, vacuum required and dilution of the urine