



**Universidad de Valladolid**



**ESCUELA DE INGENIERÍAS  
INDUSTRIALES**

**UNIVERSIDAD DE VALLADOLID**

**ESCUELA DE INGENIERIAS INDUSTRIALES**

**Grado en Ingeniería de Diseño Industrial y Desarrollo del  
Producto**

# **Implementation of collaborative robots in an assembly line**

**Autor:**

**García Castaño, Jessica**

**Responsable de Intercambio en la Uva:**

**Ángel Manuel Gento Municio**

**Universidad de destino:**

**Università Carlo Cattaneo - LIUC**

**Valladolid, junio 2018.**

**TFG REALIZADO EN PROGRAMA DE INTERCAMBIO**

---

**TÍTULO: Implementation of collaborative robots in an assembly line**

**ALUMNO: Jessica García Castaño**

**FECHA: 31/05/2018**

**CENTRO: Università Carlo Cattaneo - LIUC**

**TUTOR: Carlo Noé**

**Abstract**

Mediante el uso de algunas herramientas y técnicas de Lean Manufacturing e Industria 4.0 en la cadena de montaje de futbolines de i-FAB (espacio reservado para el personal y los estudiantes de LIUC – University Carlo Cattaneo) se puede conseguir la mejora de la productividad del proceso.

Especialmente a través del uso de los robots colaborativos, que ayudan al trabajador en las tareas más complicadas, repetitivas, precisas y más problemáticas respecto a la ergonomía.

Además, se ha diseñado un elemento que será de ayuda al trabajador y al robot colaborativo en el montaje del marcador del fútbolín.

Incorporando estas mejoras al proceso el tiempo de ciclo se reducirá, aumentará la seguridad y también la comodidad del trabajador en su puesto de trabajo.

**Key words**

Diseño industrial, robots colaborativos, cadena de montaje, mejora continua y Lean Manufacturing.

**UNIVERSITÀ CARLO CATTANEO - LIUC**

School of Industrial Engineering

Degree course of Engineering Management

**IMPLEMENTATION OF COLLABORATIVE ROBOTS IN  
AN ASSEMBLY LINE**

The members of the committee:

**Rossella Pozzi**, professor directing thesis

**Giovanni Pirovano**, assistant professor directing thesis

**Carlo Noè**, committee member

Thesis of:

**Jessica García 902457**

Thesis defended on May 31st, 2018.



## ABSTRACT

Currently, the industries are living a technological war known as Fourth Industry Revolution, to win it they have to improve each feature of their factory. The best industries nowadays, are applying the main points of 4.0 Industry as big data or collaborative robots. The propose of the project is to achieve continuous improvement in i-FAB (LIUC, Università Cattaneo) using Lean Manufacturing and 4.0 Industry tools, specifically through the use of collaborative robots. The final aim is optimizing assembly process, reducing cycle times, upgrading ergonomics performance and the quality of the final product.

**Key words:** 4.0 Industry, Lean Manufacturing, Automation, Collaborative Robots, Industrial Design, Continues Improvement and Assembly Line.



## TABLE OF CONTAINS

<b>ABSTRACT .....</b>	<b>1</b>
<b>TABLE OF FIGURES.....</b>	<b>5</b>
<b>1. Meaning of the thesis.....</b>	<b>7</b>
<b>2. Approach .....</b>	<b>8</b>
<b>3. Organization of the thesis .....</b>	<b>10</b>
<b>3.1 Introduction aspects .....</b>	<b>10</b>
3.1.1 Lean manufacturing .....	10
3.1.2 Industry 4.0.....	13
3.1.3 Group technology.....	14
3.1.4 i-FAB assembly process .....	15
3.1.4 Collaborative robots .....	16
<b>3.2 Main chapters.....</b>	<b>20</b>
3.2.1 The aims of project.....	20
3.2.2 Methodology.....	22
3.2.3 Results .....	23
<b>3.3 Conclusions .....</b>	<b>28</b>
<b>3.4 Notes .....</b>	<b>28</b>
<b>3.5 Summary.....</b>	<b>35</b>
<b>4. Bibliography.....</b>	<b>36</b>





## TABLE OF FIGURES

Figure 1: i-FAB.....	8
Figure 2: The 7 wastes.....	11
Figure 3: JIT.....	12
Figure 4: Industry 4.0.....	14
Figure 5: Advantages of cellular manufacturing .....	16
Figure 6: Chart of the estimated worldwide annual shipments of industrial by .	17
Figure 7: Current i-FAB co-robot.....	19
Figure 8: Collaborative robot from i-FAB .....	19
Figure 9: Foosball's 3D picture.....	22
Figure 10: Scoreboard's 3D model .....	22
Figure 11: 3D prototype of the box that will help collaborative robot .....	23
Figure 12: 3D photographed prototype .....	24
Figure 13: Table of "Montaggio segnapunti" .....	25
Figure 14: Table of "Assemblaggio segnapunti" .....	26
Figure 15: Table of new tasks .....	27



## **1. Meaning of the thesis**

The work has been carried out in the Erasmus term 2017-2018 at the Carlo Cattaneo University with the agreement of the University of Valladolid and the help of Ángel Gento. The theme has been agreed upon through dialogue with Professor Rosella Pozzi and Professors Giovanni Pirovano and Carlo Noè. Reach agreement on the topic that best suits Industrial Design and Product Development Engineering and the possibilities of LIUC.

The choice of the proposal answers is the need that exists to implement enhances in the industrial sector; the thesis is based on the development of these improvements in the I-FAB Simulation Factory. Specifically, in assembly of foosball's scoreboards, what the i-FAB is dedicated to.

## 2. Approach

To carry out the work, the i-FAB has been showed by the professors. I-FAB is a reserved space for the staff and students of the university, developed by LIUC - Università Cattaneo, in collaboration with Bosch-Rexroth, Bossard, Comau, Harting, Grassi, Omron-Adept, Rivetta Sistemi and Tema.

I-FAB is a laboratory that simulates how an intelligent factory works and how it is organized according to lean logic, using most of the tools of the Industry 4.0, showing all the progress of the digital technologies.

Some of those tools are:

- IoT (internet of things)
- Big data & data analytics
- Simulation
- Collaborative robots
- Additive manufacturing



Figure 1: i-FAB

Previous literature was some norms and standards that guide the project. They are valid at least until 2018.

- ISO 10218-1:2011. Robots and robotic devices. Safety requirements for industrial robots -- Part 1: Robots <sup>I</sup>.
- ISO 10218-2:2011. Robots and robotic devices. Safety requirements for industrial robots -- Part 2: Robots <sup>II</sup>.
- ISO/TS 15066. Robots and robotic devices -- Collaborative robots <sup>III</sup>.
- ISO 13849-1:2015. Safety of machinery -- Safety-related parts of control systems -- Part 1 <sup>IV</sup>.

The European Directive 2006/42 / EC on machinery is the legislation applicable to all installations in Europe.

Books like *“Lean Thinking”*, by *Daniel T. Jones* and *James P. Womack*, have been also consulted, to research more about the aspects of Lean Manufacturing and 4.0 Industry. It is considered one of the reference manuals of management and key to understanding the concept of Lean thinking: the most ideal system to create value and, at the same time, avoid waste in any organization.

To achieve the thesis' goals, all acquired knowledge in our degree and standards already mentioned have been used.

Firstly, the main aspects are defined and listed. The work focuses on the main theories that allow analyzing and studying the i-FAB's tasks, specifically in the assembly of the scoreboard into the foosball.

Besides that, the geometric analysis is thought out using 3D software. This will help to develop a new methodology, designing suitable parts for the robot to attend the worker.

Finally, the propose is checked in I-FAB, building a 3D prototype in 3D printer. To test it in the task, the collaborative robot made some trials proving the improvements and contrasting the results.

### 3. Organization of the thesis

The thesis is organized into the following topics:

1. **Introduction aspects.** All concepts around the main issue, lean manufacturing, were explained. Some topics discussed are: group technology, cellular manufacturing, collaborative robots and lean manufacturing itself.
2. **Main chapters.** It is divided in 3 chapters, the aims of the project, methodology and results. This part replies why and how the results are achieved.
3. **Conclusions.** Own opinion about the 3 months of work is exposed.
4. **Notes.** Formal documentation does not correspond with the main topics,
5. **Summary.** To sum up all the information. It gives a global vision to reader.
6. **Bibliography.** The sources on which the thesis is supported are correctly cited.

#### 3.1 Introduction aspects

##### 3.1.1 Lean manufacturing

Lean manufacturing has been long considered a way to greatly improve manufacturing efficiency; lean can be applied to any business or production process, in any industry. For example, lean is now being used extensively in the healthcare industry to improve efficiency and reduce costs. The principles can even be used, on a smaller scale, to organize your office, workspace, or laboratory.

Lean was originally created by Toyota (Soichiro Toyoda) to eliminate waste and inefficiency in its manufacturing operations. The process became so successful that it has been embraced in manufacturing sectors around the world. Nowadays, being lean is critical for competing against lower-cost countries.

When done correctly, lean can create huge improvements in efficiency, cycle time, productivity, material costs, and scrap, leading to lower costs and improved competitiveness. Consequently, the aim of lean manufacturing is to do more and better with less.

There are several key lean manufacturing principles that need to be understood in order to implement lean. The “guiding principles” of lean manufacturing are:

- **Elimination of waste**

This is one of the main critical principles of lean manufacturing is the elimination of waste (the non-value-added components in any process.), known as well as Muda in the Toyota Production System. Many of the other principles revolve around this concept.

There are 7 basic types of waste in manufacturing:

1. Waste of Unnecessary Motion
2. Over Production
3. Production of Defects
4. Waste of Inventory
5. Waste of Waiting
6. Waste of Transportation

## 7. Waste of Over processing

However, the above mentioned types of waste were originally geared toward manufacturing, they can be applied to many different types of business. The idea of waste elimination is to review all areas in your organization, determine where the non-value added work is and reduce or eliminate it.

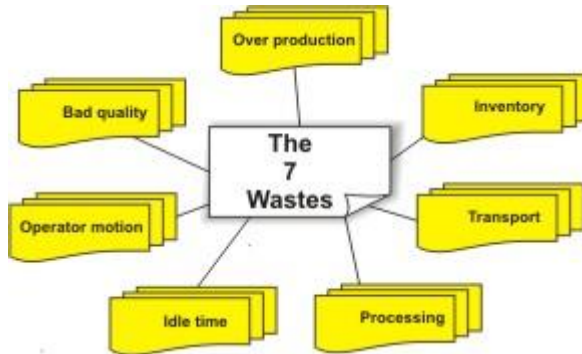

Figure 2: The 7 wastes

- **Continuous improvement**

Is also known for the Japanese word “kaizen” and is perhaps the most critical principle of lean manufacturing.

By continuing to improve your business and processes you can reduce waste as much as possible by eliminating whatever bottlenecks threaten to pop up and examining which processes are inefficient.

It should truly form the basis of your lean implementation. Without continuous improvement your progress will cease. As the name implies, Continuous improvement promotes constant, necessary change toward achievement of a desired state. The changes can be big or small but must lend itself toward improvement (often many small changes are required to achieve the target). The process truly is continual as there is always room for improvement. Although continuous improvement should be a mind-set throughout the whole organization.

- **Respect for humanity**

The most valuable resource to any company are the people who work for it. Most people want to perform well in their jobs. Not only do they go to work to earn a living, but they also want to develop a sense of worth in their work. They want to feel like they have contributed to the company goals, like their work and effort has meant something. A company supporting a respect for humanity philosophy will appreciate their workers efforts and keep them in high regard. However, without a respect for humanity and the people in your organization, there’s no way you’ll be able to consistently perform at a high level.



Some of the methods to ensure your people know you respect them is through constant communication, praise of a job well done, listening to their ideas and helping out when necessary.

- **Level production**

Known for the Japanese word “heijunka”, which means “levelling production”. In turn, this means that no matter what happens, your output remains the same every day.

Heijunka is a practice best suited to manufacturing where the product’s you’re making are either complex or take a long time to create, and when the demand for the products is fairly predictable. This is because the safety stock should allow you to always meet an order (which won’t be true if your demand spikes randomly) and having a consistent production rate is beneficial when a lot of work goes into the products.

- **Just in time (JIT)**

The basis behind this principle is to build what is required, when it is required and in the quantity required. Working in conjunction with leveled production, this principle works well with kanbans (a pull system). It allows for movement and production of parts only when required. This means components are not used in product that is not required and no time is wasted building unsaleable product.

The ultimate goal is to have absolutely no inventory, whether that be raw resources, WIP items, or finished products.

JIT doesn’t necessarily clash with Heijunka, but in most situations the method you use will depend on the complexity of your product and how predictable your demand is. Creating simple products on demand is possible because your customers won’t have to wait for very long, letting JIT flow have less of a negative in terms of how long they have to wait. Having a highly unpredictable product demand is also more suited to JIT than Heijunka, since you can’t guarantee that any safety stock created will be used up instead of becoming surplus inventory.



Figure 3: JIT

- **Quality built-in**

The concept of having quality built into your manufacturing processes is key to running an efficient, yet successful business. There's no good in rapidly producing cheap-to-make products if the final results are full of defects and won't sell, after all.

### **3.1.2 Industry 4.0**

Actually, we are entering the fourth industrial revolution. It's changing how we interact with machines and how those machines interact with each other. Computers and automation will come together in an entirely new way, with robotics connected remotely to computer systems equipped with machine learning algorithms that can learn and control the robotics with very little input from human operators.

This new era introduces what has been called the "smart factory" or also "the factory of the future" which is based in decentralized decisions between the cyber-physical systems monitor the physical processes of the factory. The physical systems become Internet of Things, communicating and cooperating both with each other and with humans in real time via the wireless web. And with networked intelligence, advanced robotics, decentralized and self-organized processes, the warehouse of the future will take a giant step forward in productivity, flexibility and efficiency.

The following points should be included in every factory that want to be called "smart factory":

- Decentralized decision-making: the ability of cyber-physical systems to make simple decisions on their own and become as autonomous as possible.
- Interoperability: machines, devices, sensors and people that connect and communicate with one another.
- Information transparency: the systems create a virtual copy of the physical world through sensor data in order to contextualize information.
- Technical assistance: both the ability of the systems to support humans in making decisions and solving problems and the ability to assist humans with tasks that are too difficult or unsafe for humans.

The benefits of an Industry 4.0 model could outweigh the concerns for many production facilities. In really dangerous working environments, the health and safety of human workers could be improved dramatically. Supply chains could be more readily controlled when there is data at every level of the manufacturing and delivery process. Computer control could produce much more reliable and consistent productivity and output. And the results for many businesses could be increased revenues, market share, and profits.

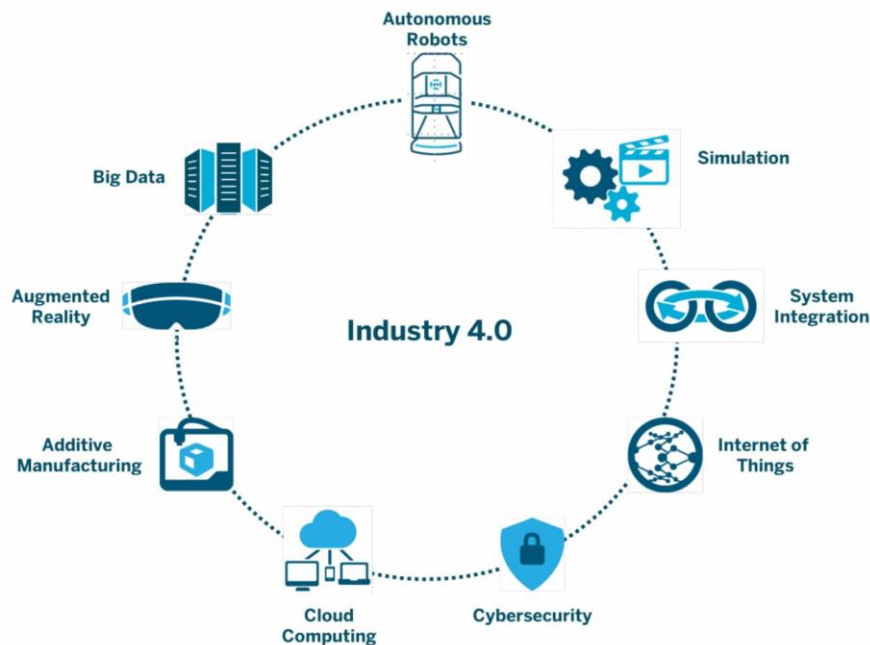

Figure 4: Industry 4.0

### 3.1.3 Group technology

Group technology, also call TG, is a philosophy created at a time when there is an increase in production companies, and these seek a way to improve, increasing efficiency and productivity. This is achieved by identifying and grouping similar parts or components to take advantage of their similarities in design and production. The similar parts are grouped into families, where the members share similarities in their form and elaboration process.

If the pieces are classified and grouped so that the characteristics of the different parts of a group are similar, the machines could also be grouped into production units where the raw pieces are taken and come out completely finished, these are called as production cells.

There are cases in which it is clearly efficient to implement GT such as: when the process is traditional and we have a large manufacturing time, the products are easily differentiable, and therefore can easily be grouped into families...

For the implementation of group technology there are two major drawbacks; the first is that all the pieces have to be examined and grouped by families, so if we have a large number of pieces this work will be costly and slow. The other impediment is the time and cost of regrouping the machinery of the factory, since depending on the size, complexity and production of these, it can suppose a very high surcharge.

Although we must also take into account the advantages offered by applying group technology in a factory. Such as the possible standardization of tools and processes, the reduction of manual operations, this in turn leads to a reduction in the number of possible accidents.

Once the group technology is applied, the product design time is reduced, since we may have already developed a product with similar characteristics, the products in

the work-in-process are reduced, and the satisfaction and level of work of the operators increases, thus making the workplace a more pleasant place.

### **3.1.4 i-FAB assembly process**

They use a process involving the use of multiple "cells" in a single assembly line, which is called cellular manufacturing. These cells are composed of one or several different machines that perform certain tasks. The product moves from one cell to another, completing part of the manufacturing process in each station. This type of process comes from the just-in-time method (JIT) and lean manufacturing which covers group technology. The goal of cellular manufacturing is to work as quickly as possible, make a wide variety of similar products and make the least waste. One of the biggest advantages of cellular manufacturing is the amount of flexibility it has. Since most machines are automatic, simple changes can be made very quickly. This allows a variety of adjustment for a product, minor variations in the entire design, and in extreme cases, transformations completely in the overall design. These changes, although tedious, can be achieved with great speed and precision.

A cell is created by consolidating the processes necessary to create a specific output, such as a part or a set of instructions. These cells allow the reduction of strange steps in the product creation process, facilitate the rapid identification of problems and encourage the communication of employees within the cell to solve problems that arise instantly. Once implemented, it has been said that cellular manufacturing reliably creates massive gains in productivity and quality, while reducing the amount of inventory, space and time needed to create a product. It is for this reason that the cell of a piece of flow has been called "the ultimate in slender production."

The cells are created in a workplace to facilitate the flow. This is achieved by gathering operations (or machines or people) involved in a sequence of processing a natural flow of products and grouping them close to each other, different from other groups. This grouping is called a cell. These cells are used to improve many factors in a manufacturing environment by allowing a one-piece flow to occur. i-FAB one-piece flow would be in the production of the scoreboard that arrives at the factory in separate pieces, requiring assembly. First, the pieces would move from storage to the cell, where they would be fixed together, then polished, then and finally screwed on the foosball. All these steps would be completed in a single cell, in order to minimize several factors (called steps / processes without added value) as the time required to transport materials between departments. Some common formats of individual cells are: the U-shape (good for communication and rapid movement of workers), the straight or L-shaped line. The number of workers within these formations depends on the current demand and can be modulated to increase or decrease production. For example, if a cell is normally occupied by two workers and the demand is doubled, four workers must be placed in the cell. Similarly, if the demand is reduced by half, a worker will occupy the cell. Since cells have a variety of different equipment, therefore, it is a requirement that any employee be expert in multiple processes.

Logically, a cell reduces flow time, flow distance, floor space, inventory, handling, planning transactions, scrapping, and repetition of work (the latter due to rapid discovery of nonconformities). In addition, the cells lead to a simplified and more valid cost

calculation, since the costs of producing articles are contained within the cell, instead of being dispersed in the distance and the passage of the reporting time.

Cellular manufacturing facilitates both production and quality control. Cells that have low volume or quality performance can be easily isolated and targeted for improvement. The segmentation of the production process allows problems to be located easily and in this way it is clearer which parts are affected or problematic.

There are also a number of benefits for employees working in cellular manufacturing. The small cell structure improves group cohesion and reduces the manufacturing process to a more manageable level for workers. Workers can more easily see problems or possible improvements within their own cells and thus tend to become more self-motivated to propose changes. In addition, these improvements that are caused by the workers themselves cause less and less need for supervision, so over time the overhead can be reduced. In addition, workers are often able to rotate between tasks within their cell, which offers variety in their work. This can further increase efficiency because the monotony of work has been linked to absenteeism and the reduction of production quality.

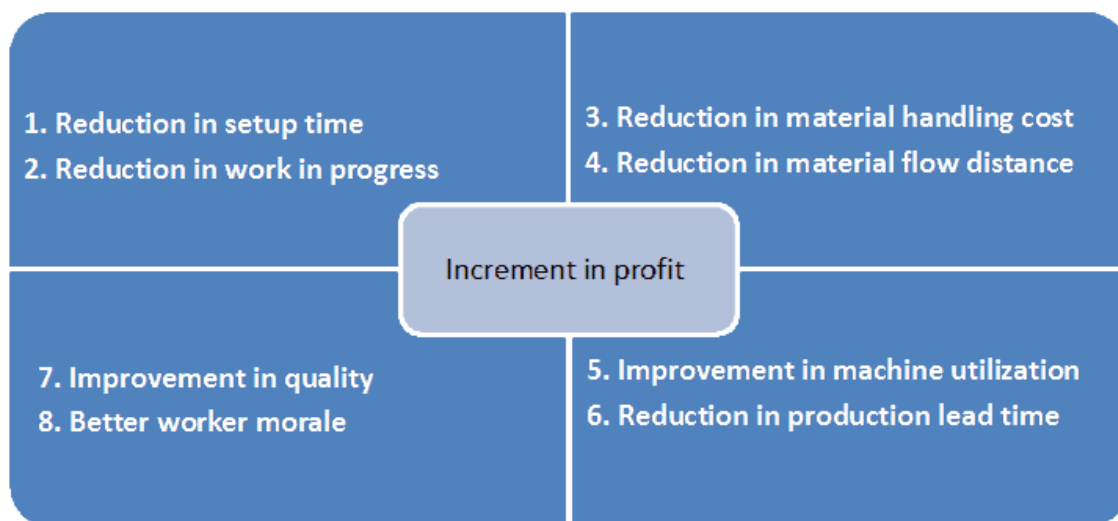

Figure 5: Advantages of cellular manufacturing

### 3.1.4 Collaborative robots

#### 3.1.4.1 From the past until now

The use of robots in industrial processes and manufacturing is nothing new or futuristic. The first example of the use of industrial robotics has its origins in the United States in 1956, although it would not jump to the European market until almost twenty years later, in 1973. Today, its application is widespread in a large variety of industrial sectors, especially in large-scale manufacturing plants where robots usually work a large number of tasks such as welding, painting, assembly, pick-and-place, product inspection and quality testing, all with great speed and precision.

Nevertheless, the latest advances in robotics technology and the miniaturization of electronic components and processors have allowed the birth of a new era in industrial automation: that of collaborative robots or "co-bots". Characterized by being lightweight,

flexible and easy to install, collections are especially for interacting with humans in a shared workspace without the need to install security fences.

### 3.1.4.1 Collaborative robots nowadays

Co-bots offer a quick return on investment, it does not require specialized technicians for its assembly and start-up, it can be reconfigured to operate in various points of a production line and allows companies to optimize their productivity. It represents a new era in industrial automation because it allows the introduction of robots in sectors and industrial processes in which, until now, it had not been viable.

The new era of industrial automation has already begun. Collaborative robots do not compete with traditional industrial robots, they are simply different. Collaborative robotics is a new form of industrial automation that complements the current offer. As companies increasingly adopt this technology, and benefit from the simplicity, flexibility and speed ROI that customers offer, more robots of this type will be seen in production processes. Industries and companies where automation is less prevalent today due to the cost, risks and lack of flexibility of traditional robots are the ones that will benefit the most from collaborative robotics over the next decade.

According to The World Robotics Report 2017, published by the International Federation of Robotics (IFR) anticipate, for 2017, an 18% growth in the facilities of industrial robots, and for 2018-2020 a growth of around 15%. Stronger than expected due to the growth in the global economy, faster business cycles, greater variety in customer demand, and the expected emergence and expansion of the "Industry 4.0".

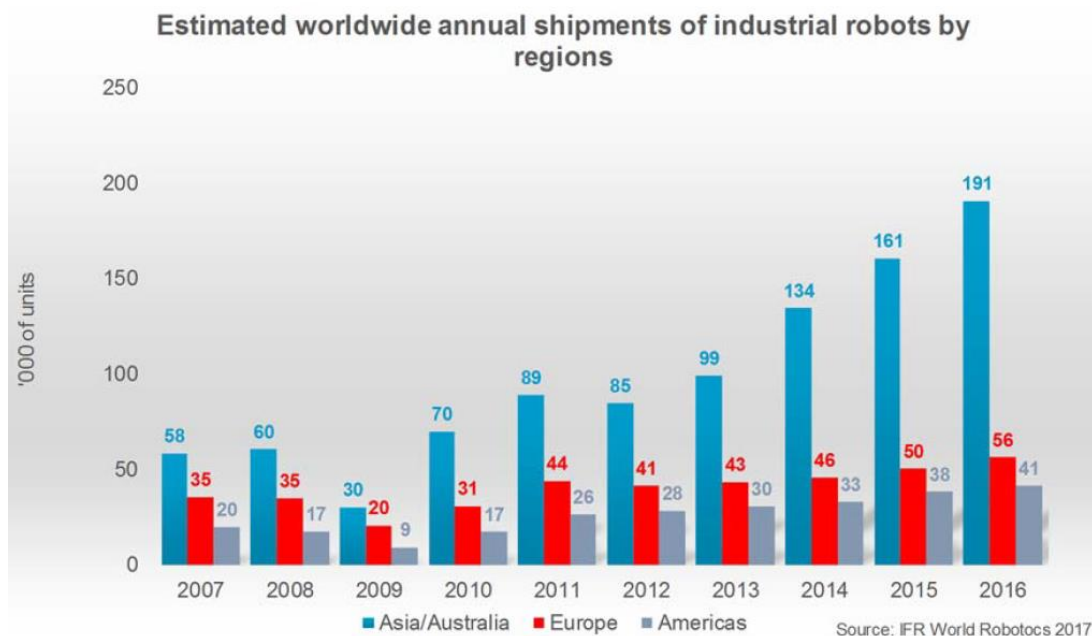

**Figure 6: Chart of the estimated worldwide annual shipments of industrial by**

Again, another more year, the IFR report sees growing demand for robotic automation in a wide range of industries, including the auto industry, electronics, rubber and plastics, food and beverages, pharmaceuticals, and metals. Asia is forecasted to lead the market growth by a wide margin, with America and also Europa showing continued growth, but at lower unit volumes.

Furthermore, Universal Robots, which is the world market leader in the co-bot segment, announced that it is expected that collaborative robots will increase their growth. The "human-robot collaboration" resembles the predominant trend, the methodology of simplification, ease of use and installation, low weight, mobility and low cost.

Also, traditional industrial robots play an important role in Industry 4.0, but even so, the expected growth for co-bots is propelled by trends such as the demand for consumer goods that shows an element of "human touch" along with a constant high quality and a constant need among SMEs to automate their manufacturing easily and affordably.

However, one of the points that is more troublesome is the employment figures. There is a controversial public debate on the consequences of an increasingly digitalized world of work on the society and economy. In particular, fears are raised that jobs might be increasingly at risk due to the use of machines and intelligent algorithms. In the discussion, macroeconomic adjustment processes are often neglected, such as the creation of new jobs and industries. But the quick spread of industrial robots hasn't made a dent in employment figures, today, new tasks have been created for the workforce alongside once performed by machines.

So, here we can see the results of the latest study by the Centre for European Economic Research (ZEW) on behalf of the German Federal Ministry for Education and Research (BMBF): *"The results of the ZEW study on the labour market confirm what we're observing in leading industrial nations across the world,"* comments Junji Tsuda, president of the International Federation of Robotics. *"The modernisation of production shifts hazardous, unhealthy and monotonous work to the machines. In the vast majority of cases, only certain activities of a job are automated and not the entire spectrum of an employee's work."* However, *if jobs are cut – the ZEW reports that 5% of employees were replaced within five years – these losses are compensated for by new jobs overall.*

*In Germany, the rise in the use of machines has allowed employment to grow by 1%. This development looks set to continue in future: based on details from companies surveyed, the ZEW estimates that further automation and digitalisation in industry will generate a 1.8% rise in employment by 2021.*

*This development tallies with experience from the 1990s onwards with the computer boom. The large-scale use of IT in companies did render traditional processing jobs superfluous. But according to calculations by the ZEW, from 1995 to 2011 employment rose by just under 0.2% per year.*

*The London School of Economics (LSE) recently published a study entitled Robots at Work on the use of industrial robots in 17 developed economies between 1993 and 2007. LSE head of research, Guy Michaels, summarised the key results at a Messe Muenchen press conference on automatic 2018: "Productivity has improved by around 15% due to industrial robots. At the same time, the proportion of low-skilled labour dropped and pay increased slightly. Industrial robots don't have any significant impact on the number of employees overall,"* said Guy Michaels, who is an associate Professor of Economics in The London School of Economics and Political Science.

To conclude, Esben Østergaard, one of the founders and inventors of Universal Robots, which is market leader within collaborative robots commented that: *"Robotic*



*automation improves consistency of quality and consistency of flow, and that's something that everyone needs. Cobots are especially compelling today for several reasons. They work together with human workers instead of replacing them – especially valuable where the loss of manufacturing jobs is a sensitive issue. They can help companies reshore manufacturing. They are particularly useful in manufacturing setups that involve higher-margin, mass-personalized products. And for SMEs cobots remain the best way to gain the benefits of automation without breaking the bank. For Universal Robots, this is truly our time”.*



Figure 7: Current i-FAB co-robot



Figure 8: Collaborative robot from i-FAB



## 3.2 Main chapters

### 3.2.1 The aims of project

#### 3.2.1.1 The continuous improvement of productivity and quality

The three main points of Lean Manufacturing are: the elimination of all types of waste, involvement of staff and respect for the worker and also the continuous improvement of productivity and quality. The objective is to eliminate the "waste" to provide the customer the product with the best quality, with the best service and delivery time at the lowest possible cost.

One of the most important things to a factory is be productive, hence, one of the main points to obtain this is to be better in the quality of the final product. Then, the continuous improvement of the quality will help to the improvement of productivity.

Specifically, in i-FAB, the objective of improving quality is to obtain the least possible quantity of failed products, to be able to be 0. This will be easier to do if collaborative robots are used, the number of failed football will decreased using co-bots, due to the are much more precise and exact than people.

#### 3.2.1.2 The improvements of the ergonomics

As is indicated before, the involvement of staff and respect for the worker is such an important thing that is a must. Hence, to make the worker comfortable in his tasks is necessary, in this point ergonomics plays an important role.

If the job station is perfectly comfortable and the worker does not have to make any inconvenient movements, he will be much more pleasant.

Thereby, collaborative robots can help workers in their tasks, because they are able to work inside tiny areas, also can make the most heavy and precise task.

#### 3.2.1.3 Implementation of collaborative robots in the process

Collaborative robots are created to make it easier for workers. They can be placed next to humans and do the most repetitive and boring jobs. Furthermore, co-bots can also provide material and tools to the operator.

Some of the most important advantages of the use of collaboratives robots are:

- They are easy to program: Make it possible for operators without programming experience to quickly configure and manage co-bots through an intuitive interface. Simply move the robotic arm to the desired points.
- The installation is very quick: Every time the time necessary to start up is less, even being only half a day. The time required for an unqualified operator to unpack the robot, assemble it and program the first simple task does not usually exceed one hour.
- Co-bots are flexible: Do not limit yourself to specialized robotics. Collaborative robots save space, are lightweight and are easily reassigned to multiple applications without the need to change their production design. In addition, they change the process easily and quickly, providing the necessary agility to

automate practically any manual task, even those involving small series or rapid format changes.

- They are also collaborative and insurance: They allow to free their workers from the most dirty, dangerous and boring tasks and reduce repetitive strain injuries and accidents. 80% of the thousands of robots distributed throughout the world operate without security guards (after due risk assessment), right next to the operators.

### 3.2.1.4 Reduction of the cycle time

The cycle time is the measure to establish the duration of a process. It is important to detail that the cycle time is the time of a single task from its beginning to its end. Hence, we will have cycle times of a single activity such as put the dices correctly; fix the crossbar to the foosball...

There are several efforts suitable for reducing cycle times. The following ideas to reduce the cycle time does not require that new equipment be purchased, they are the result of analyses the scoreboard's manufacturing.

- **Performing activities in parallel.** Most of the steps in the process are performed sequentially. A serial approach results in the time for the entire process being the sum of the individual steps plus the transport and the waiting time between steps. A parallel approach could decrease the cycle time by 80% and generate a better result.

An example is product development, where the current trend is toward concurrent engineering. Instead of succession activities, all activities take place in parallel by integrated teams. Adding co-robots to the assembly line allows keep working simultaneity.

- **Changing the sequence of activities.** The products are often transported to the robot, to the boxes and others, and then to bring them back. To solve this situation, the robot by itself picks the crossbar, assembly the dices and do not drop the piece until it is attached with the foosball.

## 3.2.2 Methodology

### 3.2.2.1 Software

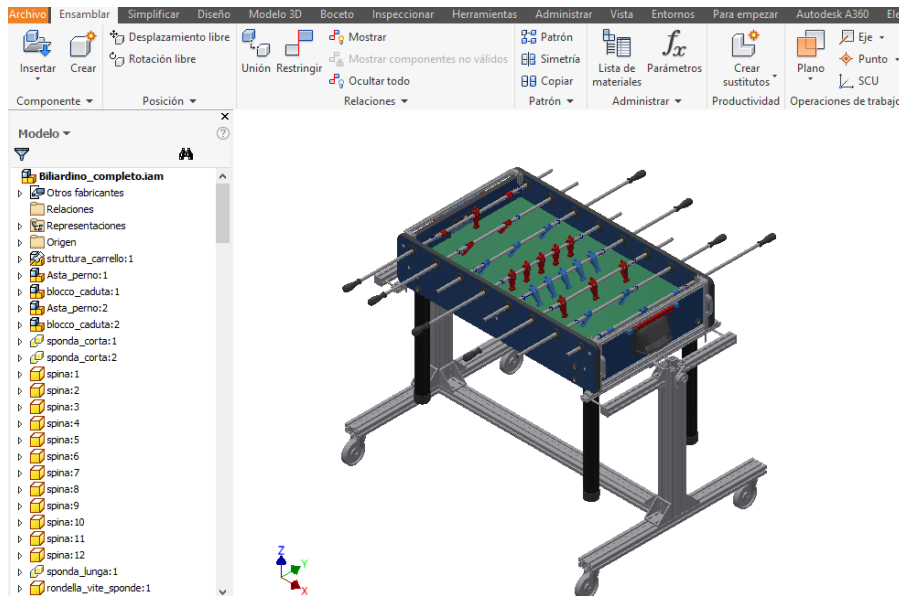

Figure 9: Foosball's 3D picture

Technically speaking, we have analyzed all the components through Inventor<sup>1</sup>, we measured, and we checked the assembly hierarchy and we discovered the different elements of the foosball.

To deeply analyze the dimensions of the pieces of the scoreboard, we made the drawings, can be found on 3.4 Notes. Once the drawings are made, we focus on the design of the box to put the dices. We modeled the 3D geometry with Catia<sup>2</sup>.

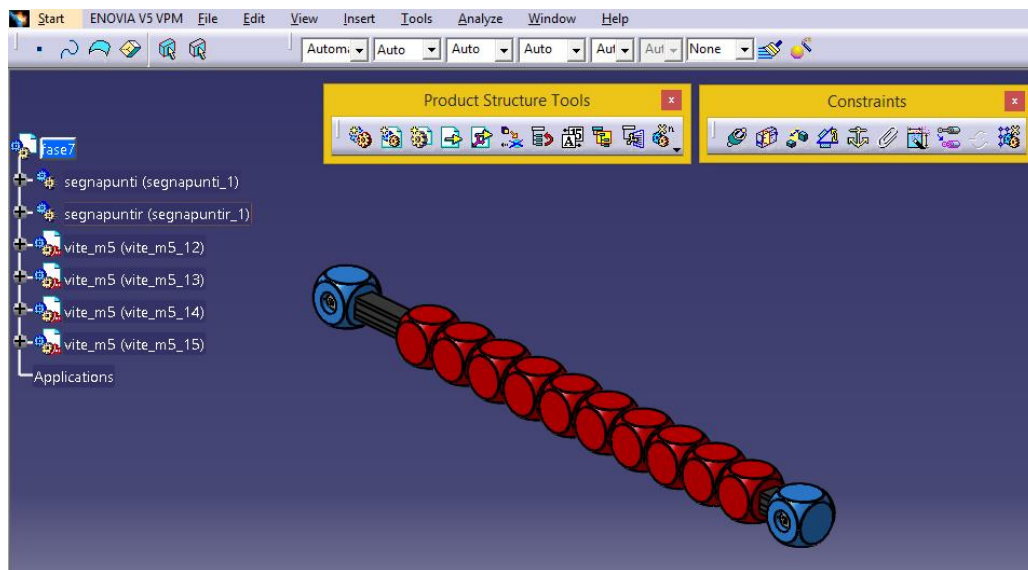

Figure 10: Scoreboard's 3D model

<sup>1</sup> It is a 3D mechanical solid modeling design software developed by Autodesk to create 3D digital prototypes

<sup>2</sup> It is a multi-platform software suite for computer-aided design (CAD), computer-aided manufacturing (CAM), computer-aided engineering (CAE), PLM and 3D, developed by the French company Dassault Systèmes.

When we verify the piece, we pass the file to the 3D printer, once manufactured we used it to put all dices and tried to fix with the collaborative robot.

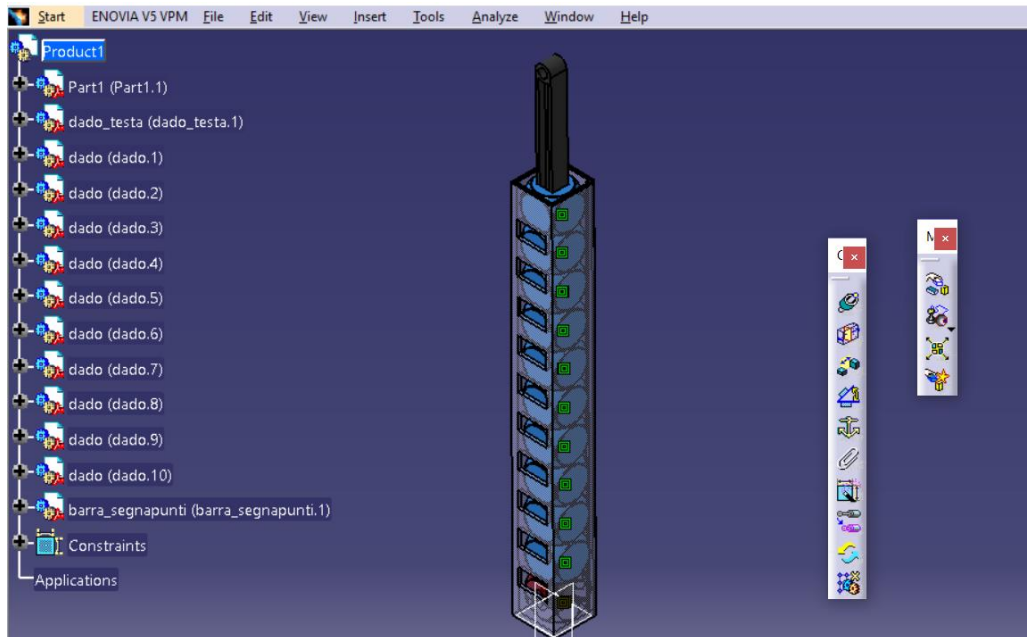

Figure 11: 3D prototype of the box that will help collaborative robot

### 3.2.2.2 Strategy

The project was based on a broad study about lean manufacturing and concepts around. Before starting the redaction, it was necessary hours of brainstorming and minds-maps to align all the information and know how start.

After all the concepts to be developed are known, the professors showed me i-FAB, where the foosball tables were assembled and analyzed were make. In addition, I learnt about the collaborative robots and 3D printers that LIUC's staff use. With the possibilities offered by the tools of i-FAB, all the pieces of the scoreboard were analyzed with the software mentioned a few lines above.

As a final goal, an improvement in the process is implemented. To get this, I worked on the design of the piece that best fits the collaborative robot. Introducing this change, the results are discussed to approve this improvement.

Referring to writing work, various sources have been consulted to develop an own opinion about the topic. Step by step, with the collaboration of the professors, the project has been corrected until it reaches the proposed objectives. For the project's presentation, a summary has been made that collects the main points, into a PowerPoint that I explained. The presentation was evaluated by three professors of the LIUC university.

### 3.2.3 Results

Firstly, a method had been designed, based on a kind of box where the dice will be introduced by the worker and then the co-robot will put the stick inside. Next, the worker will put the head-dice, and the collaborative robot will take the set and place it parallel to the table. And finally, the worker will screw it.

The piece was scrupulously designed and then printed in a 3D printer. The shape of the box was done thinking about dices' shape and measure. The dices have to fit into the box perfectly.

After 3D printing was made, it was possible to check that it was within tolerance value. It allowed to put the dices into the box and extract the kit properly.

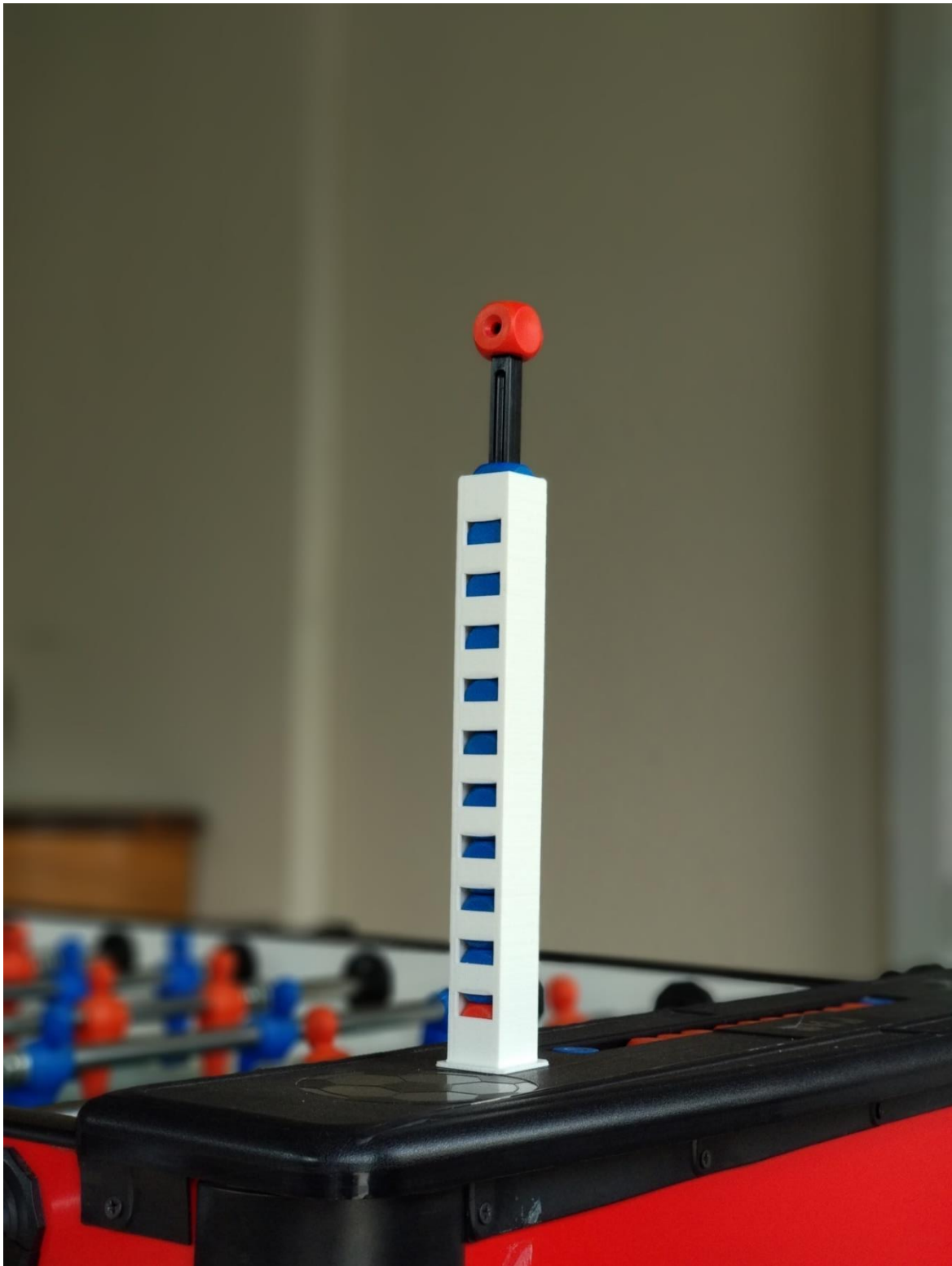

Figure 12: 3D photographed prototype

In the following tables we can see the task that the worker and the co-bot must do. Comparing the activities carried out only by the operator or by the operator and the robot.



Job element: Montaggio segnapunti				JES ID: 11
n°	Cosa	Come	Perché	Disegni
1	Inserire primo fermo	Operatore parallelo al banco di lavoro, inserire il fermo ed infilare la vite maschio dal lato senza spessore.	Affinche una volta inseriti i punti non cadano dall'altro lato.	
2	Infilare i punti	Posizionare il segnapunti perpendicolare al piano ed infilare i punti dall'alto.	Per velocizzare l'inserimento	
Pag 1 di 2				
Job element: Montaggio segnapunti				JES ID: 11
n°	Cosa	Come	Perché	Disegni
3	Infilare 2° fermo	Inserire il fermo all'estremita ed infilare la vite maschio.	Affinche i punti siano bloccati sull'asta.	

Figure 13: Table of "Montaggio segnapunti"



Job element: Assemblaggio segnapunti				JES ID: 12
n°	Cosa	Come	Perché	Disegni
1	Inserimento femmina	Operatore di fronte alla mezzaria della sponda corta, inserire viti femmina nei fori		
2	Posizionamento segnapunti	Operatore parallelo alla sponda corta, inserire segnapunti avvitando leggermente viti maschio con femmina e mantenere una mano a sostegno.	Per evitare che cada	
				Pag 1 di 2
Job element: Assemblaggio segnapunti				JES ID: 12
n°	Cosa	Come	Perché	Disegni
3	Serraggio segnapunti	Operatore parallelo alla sponda corta, con mano forte avvitatore (testa a croce, coppia 5) e con mano debole mantenere segnapunti e la femmina con un dito.	Affinché il segnapunti non cada e la vite non giri a vuoto.	

Figure 14: Table of "Assemblaggio segnapunti"

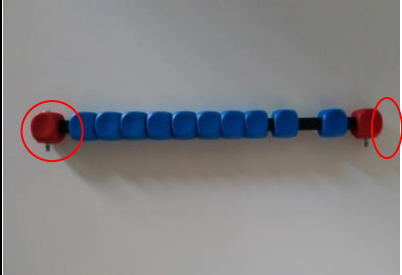
On the next figure (figure 11), the table with the new activities that the worker and the collaborative robot have to do. The worker will be helped by the co-bot, so there are some tasks that the worker will have to do and some that the co-bot will do.



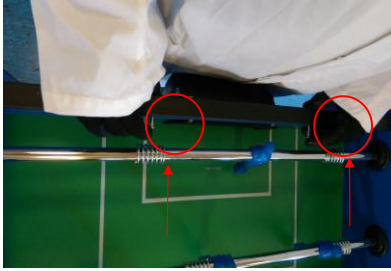
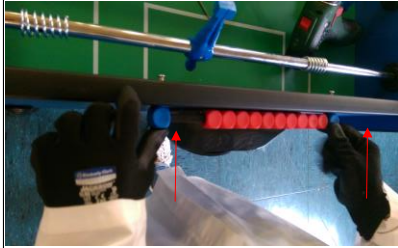



n°	Activities	Who	How	Why	Example
1	Resting position		All the elements are available on the table	In this way, it will be easy for the worker and co-bot to get the dices and stick	
2	Insert dices inside the box	Worker	Dices will be introduced into the box through the worker, first the head-dice and then the others	To accelerate the insertion of the dice	
3	Insert the stick inside the box	Co-bot	Collaborative robot will introduce the stick into the box	So that later, the co-bot can take the kit	
4	Put the head-dice in the stick	Worker and Co-bot	Worker will take the head-dice and insert it in the stick. Co-bot will stay in same position	The kit will be completed	
5	Take the kit and place it	Co-bot	Collaborative robot will take the complete kit and place it parallel to the foosball table	To make easier the screwing	
6	Screw scoreboard on the table	Worker	Worker will screw the scoreboard on the foosball table.	To fix the kit to the foosball	

Figure 15: Table of new tasks

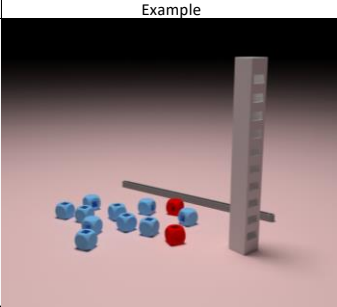
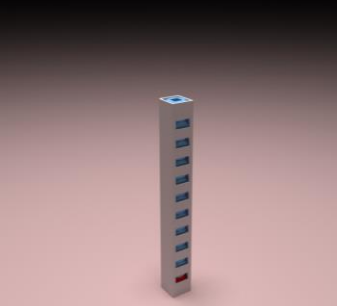

On the other hand, this table shows the task is only done by the worker. The average cycle time of the complete activity (set up the kit + assembly the kit on the table) is 27,84 sg. We can not compare this time with the new cycle time because currently the co-bot is not available, but though some simulation programs (Catia V5R21 and 3DS Max) this time can be estimated. These programs don't account the human speed to do the task, hence they are not precise, but they will give us an approximate idea about the cycle time of the process. This time will be around the previous cycle time or less. In addition, even if the cycle time is same, the worker will be able to do other task or rest.

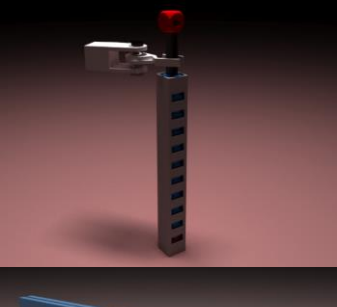
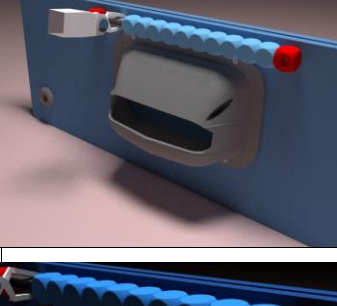
The following link is a 3D simulation of the process:

[https://www.youtube.com/watch?v=9kcu\\_9SfuGg&feature=youtu.be](https://www.youtube.com/watch?v=9kcu_9SfuGg&feature=youtu.be)

### 3.3 Conclusions

Through the use of collaborative robots, the process will be improved, improving in several points such as safety, ergonomics and lower cycle times. Assign different tasks to the workers and leave the most repetitive or difficult for the robot. All this without increasing the cycle time, the opposite, improving the rhythm.

Having design a piece that will help the robot to achieve the tasks, and in this way the worker will not have to do the most difficult task and can spend time in other tasks.

The main idea of the piece is that the dices can be introduced inside, so the robot can extract the stick with all the dices and place it in the foosball table.

From the viewpoint of the worker, they could think that the co-bot is the enemy because it executes the tasks faster, more accurately and does not earn a salary. However, this is not the situation, since the robots installed are collaborative, so without the people's help they have a lack of productive skills. This work has allowed to verify that the joint human-machine work has benefits both at the productive level and at the economic level.

### 3.4 Notes

<sup>1</sup> "ISO 10218-1:2011 - Robots and Robotic Devices -- Safety Requirements for Industrial Robots -- Part 1: Robots." n.d. Accessed April 27, 2018. <https://www.iso.org/standard/51330.html>.

ISO 10218-1:2011 specifies requirements and guidelines for the inherent safe design, protective measures and information for use of industrial robots. It describes basic hazards associated with robots and provides requirements to eliminate, or adequately reduce, the risks associated with these hazards.

ISO 10218-1:2011 does not address the robot as a complete machine. Noise emission is generally not considered a significant hazard of the robot alone, and consequently noise is excluded from the scope of ISO 10218-1:2011.

ISO 10218-1:2011 does not apply to non-industrial robots, although the safety principles established in ISO 10218 can be utilized for these other robots.

<sup>2</sup> "ISO 10218-2:2011 - Robots and Robotic Devices -- Safety Requirements for Industrial Robots -- Part 2: Robot Systems and Integration." n.d. Accessed April 27, 2018. <https://www.iso.org/standard/41571.html>

ISO 10218-2:2011 specifies safety requirements for the integration of industrial robots and industrial robot systems as defined in ISO 10218-1, and industrial robot cell(s). The integration includes the following:

- The design, manufacturing, installation, operation, maintenance and decommissioning of the industrial robot system or cell;
- Necessary information for the design, manufacturing, installation, operation, maintenance and decommissioning of the industrial robot system or cell;
- Component devices of the industrial robot system or cell.

ISO 10218-2:2011 describes the basic hazards and a hazardous situation identified with these systems, and provides requirements to eliminate or adequately reduce the risks associated with these hazards. ISO 10218-2:2011 also specifies requirements for the industrial robot system as part of an integrated manufacturing system. ISO 10218-2:2011 does not deal specifically with hazards associated with processes (e.g. laser radiation, ejected chips, welding smoke). Other standards can be applicable to these process hazards.

<sup>III</sup> "ISO/TS 15066:2016 - Robots and Robotic Devices -- Collaborative Robots." n.d. Accessed April 27, 2018. <https://www.iso.org/standard/62996.html>

ISO/TS 15066. ISO/TS 15066:2016 specifies safety requirements for collaborative industrial robot systems and the work environment, and supplements the requirements and guidance on collaborative industrial robot operation given in ISO 10218-1 and ISO 10218-2.

ISO/TS 15066:2016 applies to industrial robot systems as described in ISO 10218-1 and ISO 10218-2. It does not apply to non-industrial robots, although the safety principles presented can be useful to other areas of robotics.

NOTE This Technical Specification does not apply to collaborative applications designed prior to its publication.

<sup>IV</sup> "ISO 13849-1:2015 - Safety of Machinery -- Safety-Related Parts of Control Systems -- Part 1: General Principles for Design." n.d. Accessed April 27, 2018. <https://www.iso.org/standard/69883.html>.

ISO 13849-1:2015. ISO 13849-1:2015 provides safety requirements and guidance on the principles for the design and integration of safety-related parts of control systems (SRP/CS), including the design of software. For these parts of SRP/CS, it specifies characteristics that include the performance level required for carrying out safety functions. It applies to SRP/CS for high demand and continuous mode, regardless of the type of technology and energy used (electrical, hydraulic, pneumatic, mechanical, etc.), for all kinds of machinery.

It does not specify the safety functions or performance levels that are to be used in a particular case.

This part of ISO 13849 provides specific requirements for SRP/CS using programmable electronic system(s).

It does not give specific requirements for the design of products which are parts of SRP/CS. Nevertheless, the principles given, such as categories or performance levels, can be used.

COMPLEMENT 1 Examples of products which are parts of SRP/CS: relays, solenoid valves, position switches, PLCs, motor control units, two-hand control devices, pressure sensitive equipment. For the design of such products, it is important to refer to the specifically applicable International Standards, e.g. ISO 13851, ISO 13856-1 and ISO 13856-2.

COMPLEMENT 2. For the definition of required performance level, see 3.1.24.

COMPLEMENT 3. The requirements provided in this part of ISO 13849 for programmable electronic systems are compatible with the methodology for the design and development of safety-related electrical, electronic and programmable electronic control systems for machinery given in IEC 62061.

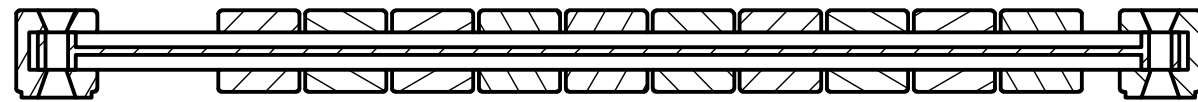

A-A

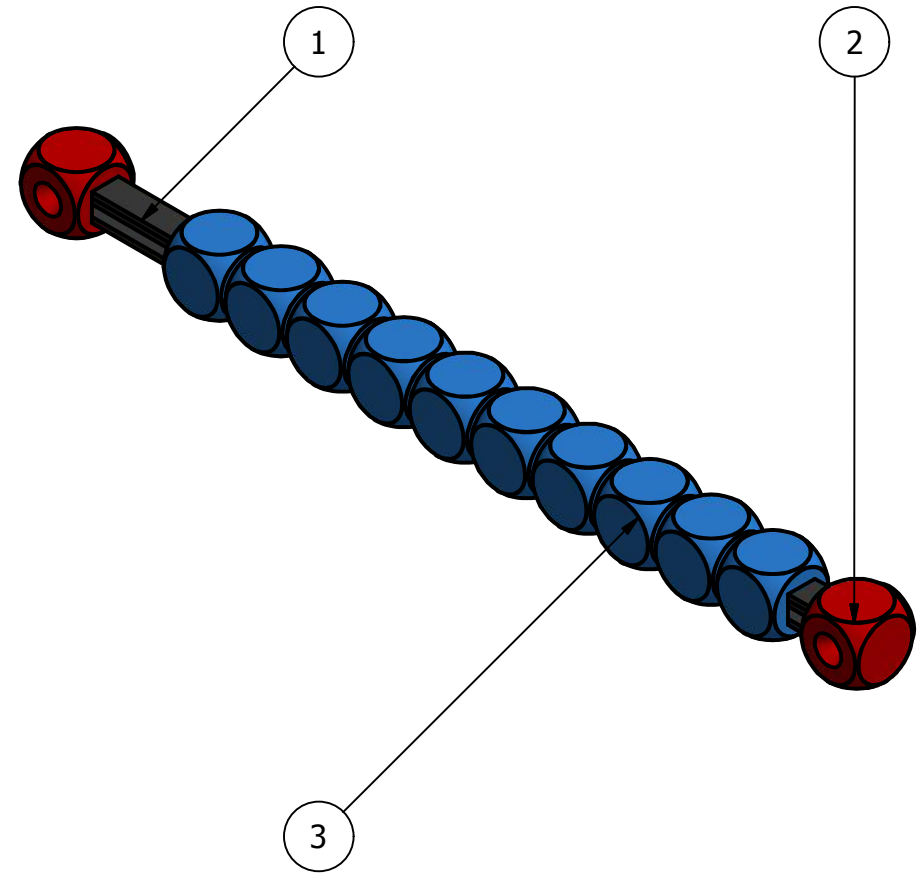
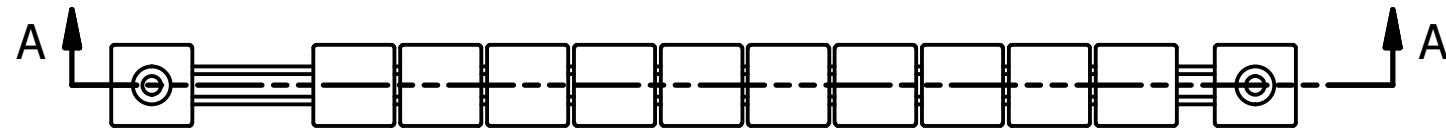

PARTS LIST			
ITEM	QTY	FILE NAME	MATERIAL
1	1	BARRA SEGNAPUNTI	Generic
2	2	DADO TESTA	Generic
3	10	DADO	Generic
<b>DRAWN</b>		UNIVERSITA' CARLO CATTANEO - LIUC	
JAVIER SARABIA & JESSICA GARCÍA		4/4/2018	 C.SO MATTEOTTI, 22 - 21053 CASTELLANZA (VA) CODICE FISCALE E PARTITA IVA 02015300128
<b>CHECKED</b>			
JAVIER SARABIA SIGNATURE			
JESSICA GARCÍA SIGNATURE			
LIUC SIGNATURED			<b>SIZE</b> A3
			<b>DWG NO</b> SHEGNAPUNTI
			<b>SCALE</b> 1 / 2 mm
			<b>SHEET 1 OF 4</b>

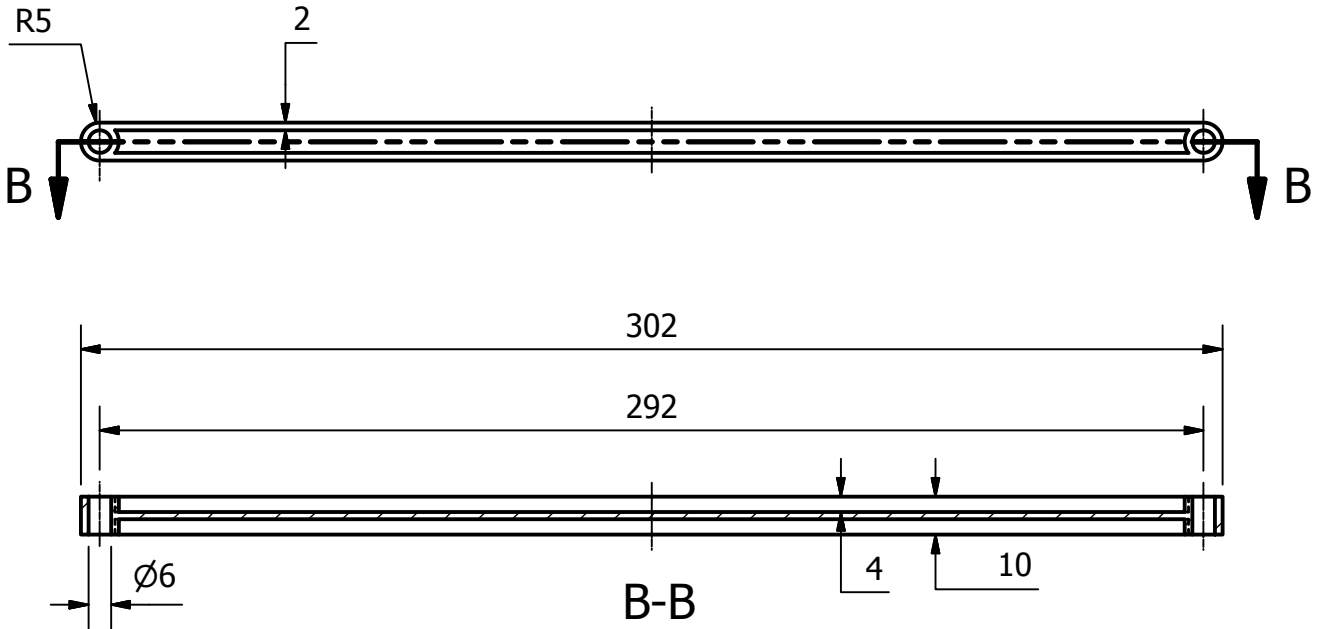

<b>DRAWN</b> JAVIER SARABIA & JESSICA GARCÍA	4/4/2018	UNIVERSITA' CARLO CATTANEO - LIUC		
<b>CHECKED</b>		 C.SO MATTEOTTI, 22 - 21053 CASTELLANZA (VA) CODICE FISCALE E PARTITA IVA 02015300128		
<b>JAVIER SARABIA SIGNATURE</b>				
<b>JESSICA GARCÍA SIGNATURE</b>				
<b>LIUC SIGNATURED</b>		<b>SIZE</b> A4	<b>DWG NO</b> BARRA SEGNAPUNTI	<b>N°</b> 1
		<b>SCALE</b> 1 / 2 mm	<b>SHEET 2 OF 4</b>	

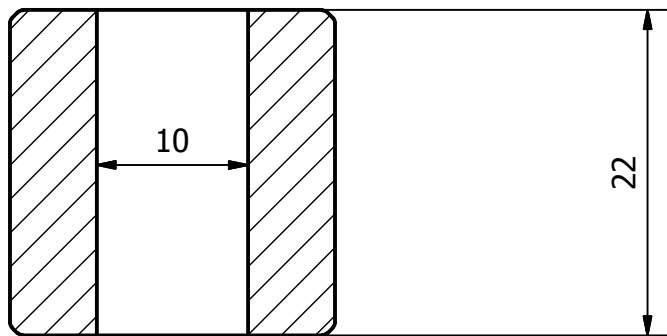
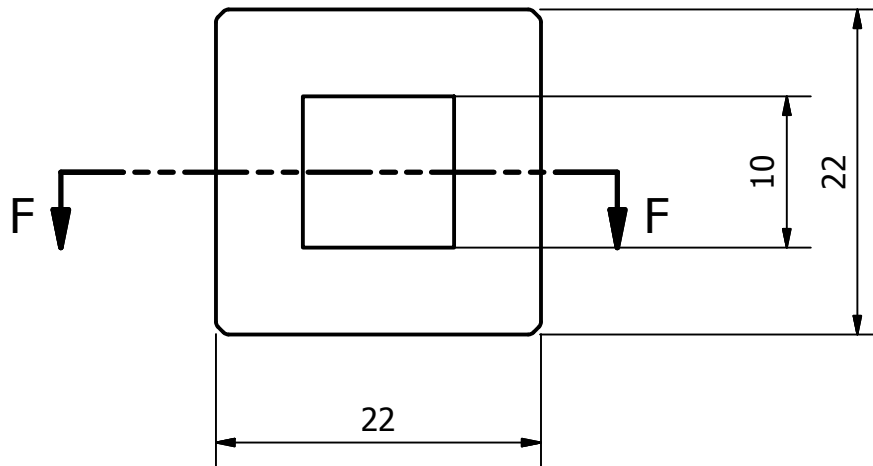

F-F

<b>DRAWN</b> JAVIER SARABIA & JESSICA GARCÍA	4/4/2018	UNIVERSITA' CARLO CATTANEO - LIUC	
<b>CHECKED</b>		 C.SO MATTEOTTI, 22 - 21053 CASTELLANZA (VA) CODICE FISCALE E PARTITA IVA 02015300128	
<b>JAVIER SARABIA SIGNATURE</b>			
<b>JESSICA GARCÍA SIGNATURE</b>			
<b>LIUC SIGNATURED</b>		<b>SIZE</b> A4	<b>DWG NO</b> DADO
		<b>SCALE</b> 2 : 1 mm	<b>N°</b> 3
		<b>SHEET 4 OF 4</b>	

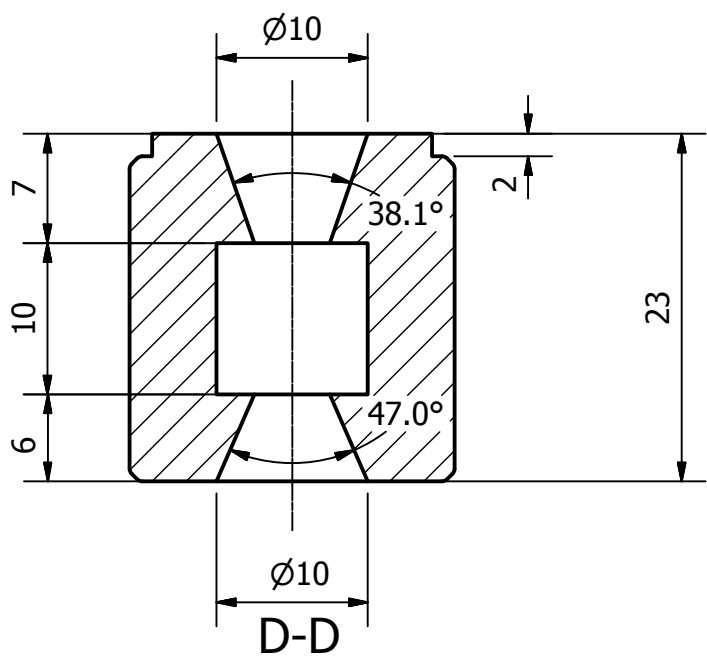
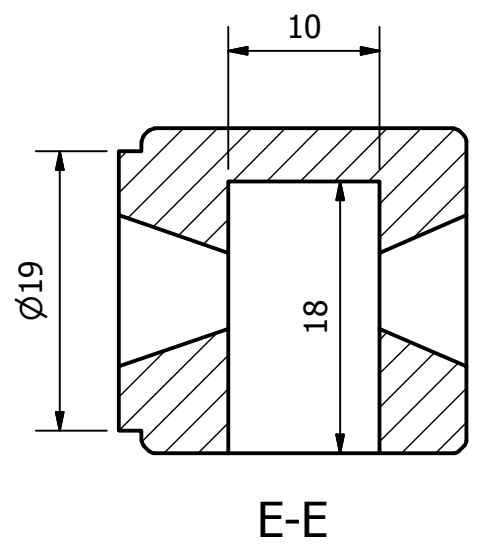
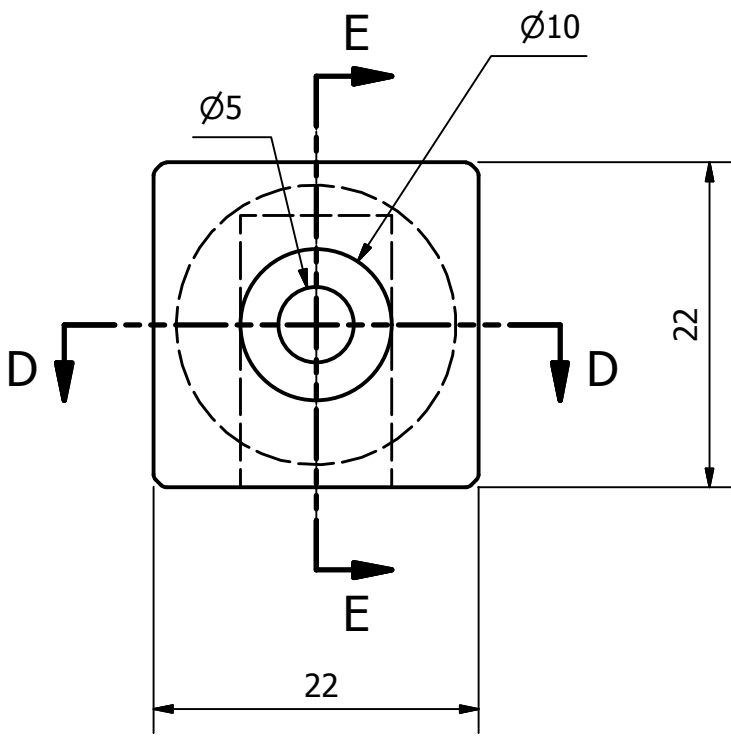

<b>DRAWN</b> JAVIER SARABIA & JESSICA GARCÍA	4/4/2018	UNIVERSITA' CARLO CATTANEO - LIUC		
<b>CHECKED</b>		 C.SO MATTEOTTI, 22 - 21053 CASTELLANZA (VA) CODICE FISCALE E PARTITA IVA 02015300128		
<b>JAVIER SARABIA SIGNATURE</b>				
<b>JESSICA GARCÍA SIGNATURE</b>				
<b>LIUC SIGNATURED</b>		<b>SIZE</b> A4	<b>DWG NO</b> DADO TESTA	<b>N°</b> 2
		<b>SCALE</b> 2 : 1 mm	<b>SHEET 3 OF 4</b>	

### **3.5 Summary**

From the human point of view, it is crucial to know the needs, in this case work needs, which allow the worker to be more effective. No collaborative implementation would be useful if it is not an improvement of the process, on quality, time or ergonomics. In each research of this thesis, an infinity of news about famous firms has been appeared, these companies proposes many collaborative integrations in their processes through new robots and intelligent machines on the market

The new technological point of view that the industry is getting, is showing the current need to automate tasks and process. This is a requirement in order to be competitive against the rivalry.

Furthermore, robotics in general, and collaborative robots in particular, is a field of study that nowadays is booming, a lot of companies and universities research to develop techniques that currently exist, as i-FAB, which is where take place the simulation of an assembly chain.



## 4. Bibliography

- “EUR-Lex - 32006L0042 - EN - EUR-Lex.” n.d. Accessed April 27, 2018. <https://eur-lex.europa.eu/legal-content/EN/TXT/?uri=celex:32006L0042>
- “ISO 10218-2:2011 - Robots and Robotic Devices -- Safety Requirements for Industrial Robots -- Part 2: Robot Systems and Integration.” n.d. Accessed April 27, 2018. <https://www.iso.org/standard/41571.html>
- “ISO 10218-1:2011 - Robots and Robotic Devices -- Safety Requirements for Industrial Robots -- Part 1: Robots.” n.d. Accessed April 27, 2018. <https://www.iso.org/standard/51330.html>
- “Industry 4.0 - Only One-Tenth of Germany’s High-Tech Strategy | Automation.com.” n.d. Accessed June 3, 2018. <https://www.automation.com/automation-news/article/industry-40-only-one-tenth-of-germanys-high-tech-strategy/>
- “What Everyone Must Know About Industry 4.0.” n.d. Accessed June 3, 2018. <https://www.forbes.com/sites/bernardmarr/2016/06/20/what-everyone-must-know-about-industry-4-0/#3290525795f7>.
- “Group Technology and Productivity.” n.d. Accessed May 18, 2018. <https://hbr.org/1984/07/group-technology-and-productivity>
- “TECNOLOGIA DE GRUPOS | Procesos-Manufactura.” n.d. Accessed May 18, 2018. <http://camiloguevara96.wixsite.com/procesos-manufactura/single-post/2015/11/17/TECNOLOGIA-DE-GRUPOS>
- “Advantages of Cellular Manufacturing.” n.d. Accessed May 18, 2018. <http://www.whatissixsigma.net/cellular-manufacturing-advantages/>
- “Las Células de Trabajo Personalizadas Promueven El Trabajo En Equipo | Trilogiq.” n.d. Accessed May 18, 2018. <https://trilogiq.es/las-celulas-de-trabajo-personalizadas-promueven-el-trabajo-en-equipo/>
- “Cómo Aplicar Métrica Cycle Time Para Obtener Lean Process.” n.d. Accessed May 18, 2018. <http://www.manufacturainteligente.com/aplicar-cycle-time-obtener-lean-process/>
- “Cycle Time | iSixSigma.” n.d. Accessed May 18, 2018. <https://www.isixsigma.com/dictionary/cycle-time/>
- “Robots Colaborativos O Cobots En Interacción Con Humanos En Las Fábricas.” n.d. Accessed April 16, 2018. <http://www.plastico.com/temas/Los-cobots-estan-dispuestos-a-trabajar-contigo+108382>
- “Why Co-Bots Will Be a Huge Innovation and Growth Driver for Robotics Industry - IEEE Spectrum.” n.d. Accessed April 16, 2018.

<https://spectrum.ieee.org/automaton/robotics/industrial-robots/collaborative-robots-innovation-growth-driver>

“Robotics Industry Insights - Collaborative Robots and ...” n.d. Accessed April 16, 2018. [https://www.robotics.org/content-detail.cfm/Industrial-Robotics-Industry-Insights/Collaborative-Robots-and-Safety-Hand-in-Hand/content\\_id/6198](https://www.robotics.org/content-detail.cfm/Industrial-Robotics-Industry-Insights/Collaborative-Robots-and-Safety-Hand-in-Hand/content_id/6198)

“Ford Shows How Humans and Robots Work Hand-in-Hand on Its Assembly Line | TechCrunch.” n.d. Accessed April 16, 2018. [https://techcrunch.com/2016/07/14/ford-shows-how-humans-and-robots-work-hand-in-hand-on-its-assembly-line/?ncid=rss&utm\\_source=feedburner&utm\\_medium=feed&utm\\_campaign=sfgplus&sr\\_share=googleplus&%3Fncid=sfgplus](https://techcrunch.com/2016/07/14/ford-shows-how-humans-and-robots-work-hand-in-hand-on-its-assembly-line/?ncid=rss&utm_source=feedburner&utm_medium=feed&utm_campaign=sfgplus&sr_share=googleplus&%3Fncid=sfgplus)

“Rise of the Cobot (Market Analysis and Forecast) | FourByThree.” n.d. Accessed April 16, 2018. <http://fourbythree.eu/rise-of-the-cobot-market-analysis-and-forecast/>

“Rise of the Cobots: By 2025, the Market for Collaborative Robotics Is Expected to Reach \$12 Billion | PlasticsToday.” n.d. Accessed April 16, 2018. <https://www.plasticstoday.com/automation/rise-cobots-2025-market-collaborative-robotics-expected-reach-12-billion/114014787947422>

“International Federation of Robotics.” n.d. Accessed May 9, 2018. <https://ifr.org/ifr-press-releases/>

“Cobots Forecasted Accelerating Growth through 2020.” n.d. Accessed May 9, 2018. <https://www.universal-robots.com/about-universal-robots/news-centre/ifr-world-robotics-report-2017/>

“The Impact of Robots on Productivity, Employment and Jobs - International Federation of Robotics.” n.d. Accessed May 9, 2018. <https://ifr.org/ifr-press-releases/news/position-paper>

“ZEW Project: Digitalisation and the Future of Work: Macroeconomic Consequences for Tomorrow’s Employment, Unemployment and Wages.” n.d. Accessed May 9, 2018. <http://www.zew.de/en/forschung/digitalisation-and-the-future-of-work-macroeconomic-consequences-for-tomorrows-employment-unemployment-and-wages/?cHash=ffe6870c319c2ca20ea71af6025d3050>

Robotics, World. 2017. “Executive Summary World Robotics 2017 Industrial Robots.” *World Robotic Report*, 15–24. [https://ifr.org/downloads/press/Executive\\_Summary\\_WR\\_2017\\_Industrial\\_Robots.pdf](https://ifr.org/downloads/press/Executive_Summary_WR_2017_Industrial_Robots.pdf)

Valletta Luca. 2017. “Corso Di Laurea in Ingegneria Gestionale: Applicazione Del Lean Assessment E Implementazione Dello Standard Work.”

UNIVERSITÀ CARLO CATTANEO - LIUC.

<http://www.biblio.liuc.it/scripts/biblio/laureati/qx.asp?19416>.