



**Universidad de Valladolid**



**ESCUELA DE INGENIERÍAS  
INDUSTRIALES**

**UNIVERSIDAD DE VALLADOLID**

**ESCUELA DE INGENIERIAS INDUSTRIALES**

**Grado en Ingeniería Mecánica**

**Effects of Processing Parameters on the Sur-  
face Quality of Web Based Thermoplastic  
Composites Manufactured in an Automated  
Process**

**Autor:**

**Barbero García, Elías**

**María Isabel Sánchez Bascones**

**Universität Augsburg**

**Valladolid, septiembre 2017.**

**TFG REALIZADO EN PROGRAMA DE INTERCAMBIO**

---

**TÍTULO:**       **Effects of Processing Parameters on the Surface Quality of Web Based Thermoplastic Composites Manufactured in an Automated Process.**

**ALUMNO:**       **Elías Barbero García**

**FECHA:**        **15/09/2017**

**CENTRO:**       **Universität Augsburg**

**TUTOR:**        **Univ.-Prof. Dr.-Ing. Stefan Schlichter**

**RESUMEN:**

Este TFG se centra en la mejora de la calidad superficial de las piezas producidas a partir de web composites mediante un proceso automatizado. Para lograr esto, se llevó a cabo un estudio pormenorizado de los factores de influencia. Diversas pruebas junto a un diseño experimental fueron realizadas buscando conocer cuánto influye cada factor en la calidad superficial. Finalmente, a partir de los resultados derivados de esta experimentación, distintas pruebas fueron ejecutadas con el objetivo de obtener piezas con una calidad superficial mejorada.

**CINCO PALABRAS CLAVE:**

Proceso, calidad, composites, fibra de carbono, parámetros.

The work was submitted to the  
**Institut für Textiltechnik Augsburg gGmbH**

Univ.-Prof. Dr.-Ing. Stefan Schlichter

Effects of Processing Parameters on the Surface Quality of Web Based  
Thermoplastic Composites Manufactured in an Automated Process

Presented as: Bachelor Thesis

by: Elias Barbero

Matr.-No. 1528523

1<sup>st</sup> examiner: Univ.-Prof. Dr.-Ing. Stefan Schlichter

2<sup>nd</sup> examiner: Prof. Dr. Siegfried R. Horn

Supervisor: Dr.-Ing. Philipp Abel

Augsburg, September 2017

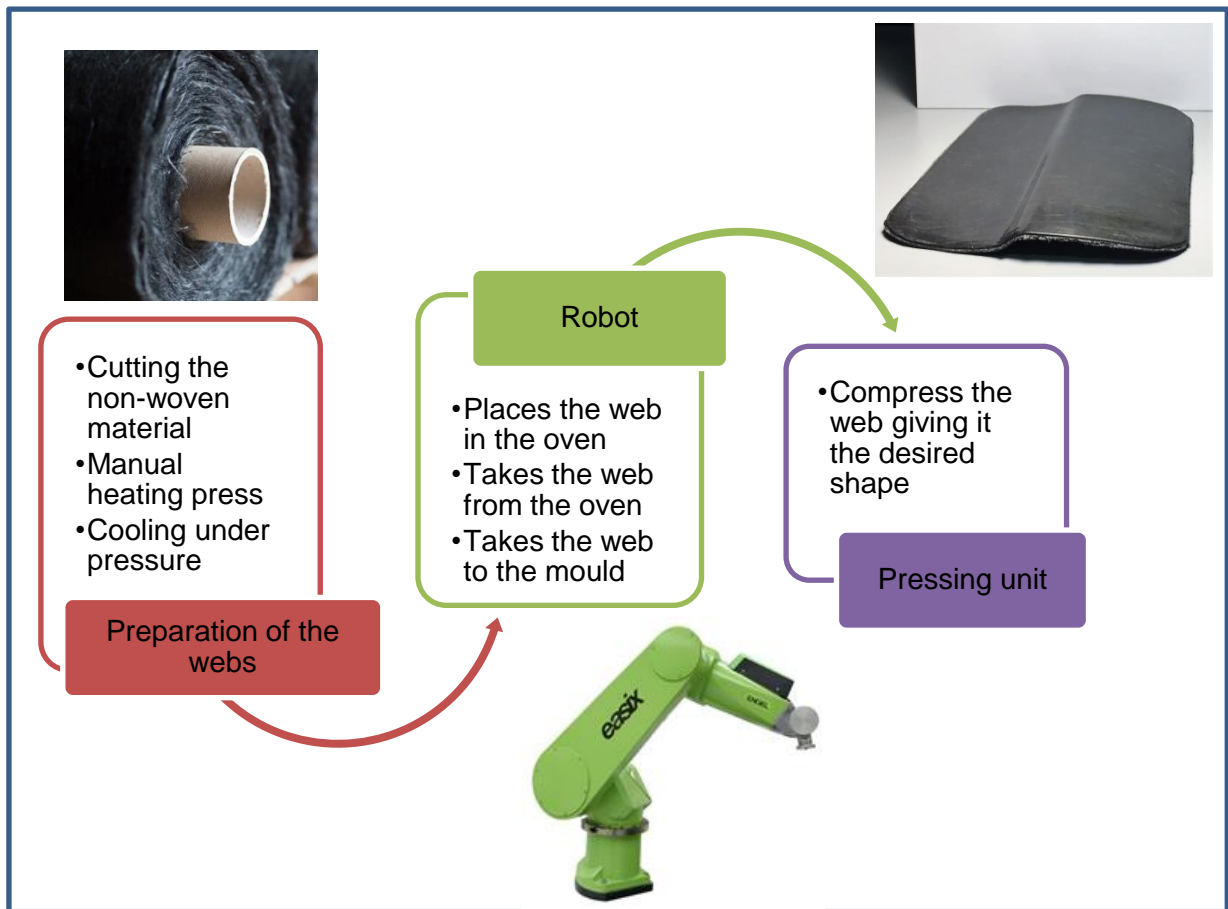

**2017**  
**Bachelor Thesis**

**Effects of Processing Parameters on the Surface Quality of Web Based Thermoplastic Composites Manufactured in an Automated Process**

**Elias Barbero**

## **Abstract**

This thesis focuses on the improvement of the surface quality of the parts produced from web-based thermoplastic composites by an automatic process. For bringing to successful conclusion this assignment a detailed study of the factors influencing this aspect was completed. Later, early trials together with an experimental design were carried out in order to see how each factor influences the quality of the surface. Finally, from the results derived by the previous experimentation, several tests were executed with the aim of getting final parts with an improved surface quality.

**Keywords:** Process, Parameters, Composites, Carbon Fibre

## Index

<b>1</b>	<b>Introduction and Objectives .....</b>	<b>13</b>
<b>2</b>	<b>State of the art .....</b>	<b>15</b>
2.1	Introduction to composite materials .....	15
2.2	Carbon fibres.....	16
2.2.1	Introduction to carbon fibres .....	16
2.2.2	Manufacturing process of carbon fibre.....	16
2.2.3	Properties of carbon fibres .....	17
2.2.4	Types of carbon fibres .....	18
2.3	Recycling of composites.....	18
2.3.1	The need of recycling .....	18
2.3.2	Legislation .....	19
2.3.3	Thermoplastics and thermosetting plastics .....	20
2.3.4	Recycling processes .....	21
2.3.5	Critical length of fibre.....	23
2.4	Matrix .....	24
2.4.1	Polyamid .....	24
2.5	Nonwoven .....	25
2.5.1	Concept of nonwoven.....	25
2.5.2	Dry-Laid.....	26
2.5.3	Dilo compact system .....	28
2.6	Component production of carbon fibre.....	29
2.6.1	Thermoforming of organic sheets .....	29
2.6.2	Resin transfer moulding.....	29
2.6.3	Thermoforming and injection moulding.....	30
<b>3</b>	<b>Production process.....</b>	<b>31</b>
3.1	Infrared oven .....	32
3.2	Handling system.....	32
3.3	Pressing unit .....	34
3.4	Induction unit.....	35
<b>4</b>	<b>Preparation of the experiments .....</b>	<b>37</b>
4.1	Objectives .....	37
4.2	Preparation of the preforms.....	37
4.3	First trials.....	38
4.3.1	Parameters of the first experiments .....	39
4.3.2	Conclusions and images of the first experiments.....	40
4.3.3	Images of the first experiments.....	40
4.4	Experimental design .....	43
4.5	Parameters of the process .....	46

---

4.5.1	Temperature.....	46
4.5.2	Pressure.....	46
4.5.3	Time.....	46
4.5.4	Press parameters.....	47
4.5.5	Induction unit.....	48
<b>5</b>	<b>Evaluation and statistical study .....</b>	<b>49</b>
<b>6</b>	<b>Final experiments.....</b>	<b>52</b>
6.1	Reduction of the level of penetration of the needles .....	52
6.2	Reduction of the cycle times.....	53
6.3	Thermal impact reduction .....	53
6.4	Application of a layer of polyamide .....	55
6.5	Results and images.....	56
<b>7</b>	<b>Summary, conclusions and outlook .....</b>	<b>63</b>
7.1	Summary.....	63
7.2	Conclusions.....	63
7.3	Outlook.....	65
<b>8</b>	<b>Bibliography .....</b>	<b>66</b>
<b>9</b>	<b>Attachments .....</b>	<b>69</b>
<b>10</b>	<b>Statement of academic honesty .....</b>	<b>73</b>



## List of Figures

Fig. 2.1:	Stress vs strain for fibre and matrix separated (a) and altogether (b). [CR14].....	15
Fig. 2.2:	Simplified representation of manufacturing process of carbon fibres from PAN precursors. [PH10].....	17
Fig. 2.3:	Global demand for Carbon fibre in 1,000 tonnes 2010 to 2022 (*Estimation). .....	19
Fig. 2.4:	Pyramid in regard to waste management. [SGG16] .....	20
Fig. 2.5:	Energy demand in composite recycling methods. [SGG16].....	22
Fig. 2.6:	Energy contrast between production and recycling carbon fibre processes.....	22
Fig. 2.7:	Stress-position depending on the length of the fibre. [CR14].....	23
Fig. 2.8:	Possible layups and applications examples of organic sheets. [SGL17]....	26
Fig. 2.9:	Diagram of the carding process. [ED17].....	27
Fig. 2.10:	Diagram of the airlaid process. [ED17].....	27
Fig. 2.11:	Diagram of Dilo system for nonwoven production. [Mar17].....	28
Fig. 2.12:	Key stages in the thermoforming process for reinforced thermoplastic composites. [RAR12] .....	29
Fig. 2.13:	Step process of thermoforming combined with injection moulding. [Kra17] .....	30
Fig. 3.1:	Top view of the manufacturing process. [Ege17].....	31
Fig. 3.2:	Infrared oven and its components. [EnM16] .....	32
Fig. 3.3:	Stäubli robot and its rotation axes. [EnM16] .....	33
Fig. 3.4:	Image of the needle group in detail (extended position). .....	33
Fig. 3.5:	Image of the second holding system with vacuum circuit. ....	34
Fig. 3.6:	Pressing unit opened with the pressing and injection moulds. ....	35
Fig. 3.7:	Plant vision of the induction plates. ....	36
Fig. 4.1:	Flowchart of the web preparation process. ....	38
Fig. 4.3:	T <sup>a</sup> of 250 °C without polyamide with critic movements at 100% speed. ....	41
Fig. 4.4:	T <sup>a</sup> of 300 °C without polyamide with soft movements at 10% speed.....	42
Fig. 4.5:	T <sup>a</sup> of 275 °C with polyamide with critic movements at 50% speed. ....	42
Fig. 4.6:	T <sup>a</sup> of 225 °C with polyamide with critic movements at 100% speed. ....	43
Fig. 4.7:	T <sup>a</sup> of 275 °C with polyamide with critic movements at 100% speed. ....	43
Fig. 4.8:	Flowchart of the polyester webs preparation process. ....	45
Fig. 4.9:	Flowchart of the automated process cycle done by the robot. ....	47
Fig. 4.10:	Representation of speed (mm/s) and force (kN) versus distance (mm). ....	47
Fig. 6.1:	Two needle grippers holding a composite web. [Die17].....	52
Fig. 6.2:	Distribution of temperatures in a composite web before being compressed. Source: ITA.....	54
Fig. 6.3:	Explanatory flowchart of the process cycle done by the robot. ....	55
Fig. 6.4:	Final piece corresponding to web number 1. ....	57
Fig. 6.5:	Final piece corresponding to web number 2. ....	57
Fig. 6.6:	Final piece corresponding to web number 4. ....	58
Fig. 6.7:	Final piece corresponding to web number 5. ....	58

---

Fig. 6.8:	Final piece corresponding to web number 6.....	59
Fig. 6.9:	Final piece corresponding to web number 9.....	59
Fig. 6.10:	Final piece corresponding to web number 10.....	60
Fig. 6.11:	Final piece corresponding to web number 11.....	60
Fig. 6.12:	Comparison between webs 1 and 4 needle marks. ....	61
Fig. 6.13:	Comparison between webs 5 and 6 needle marks. ....	61
Fig. 6.14:	Comparison between webs 10 and 11 needle marks. ....	62

---

## List of Tables

Tab. 2.1:	Carbon fibre supply and demand. [A16] .....	19
Tab. 2.2:	Properties of polyamide and polyester. [RLL11] .....	24
Tab. 2.3:	Influence of water content on polyamide. [RLL11] .....	25
Tab. 4.1:	Parameters values of the figures attached. ....	41
Tab. 4.2:	Dependent variable combinations in the experiment. ....	44
Tab. 5.1:	Roughness average values from different zones of the tested webs. ....	49
Tab. 5.2:	ANOVA table for variable Roughness, type III Sums of Squares. ....	50
Tab. 6.1:	General characteristics of the needle group. [Die17] .....	52
Tab. 6.2:	Specifications of the last experiments made.....	56
Tab. 6.3:	Main features of web number 1. ....	57
Tab. 6.4:	Main features of web number 2. ....	57
Tab. 6.5:	Main features of web number 4. ....	58
Tab. 6.6:	Main features of web number 5. ....	58
Tab. 6.7:	Main features of web number 6. ....	59
Tab. 6.8:	Main features of web number 9. ....	59
Tab. 6.9:	Main features of web number 10. ....	60
Tab. 6.10:	Main features of web number 11. ....	60
Tab. 7.1:	Parameter values of the webs with the best surface quality. ....	65

## Abbreviations

CF	Carbon Fibre
TFP	Tailored Fibre Placement
CFRC	Carbon Fibre Reinforced Composites
CFRP	Carbon Fibre Reinforced Plastics
RTM	Resin Transfer Moulding
ITA	Institute of Textile Technology Augsburg
PAN	Polyacrylonitrile
PE	Polyester fibre
PA	Polyamide
Dilo	Dilo KO1.34290.16 ITA compact system
Insert H	Engel insert 1050H 200

# 1 Introduction and Objectives

Actually, composite recycling is still in development. It is necessary to mention that the majority of products that contain composite components have a long service life and will not be available for recycling in some years by which the growth of the recycling industry does not resemble to the one of manufacturers.

Apart from the previously mentioned, there is another challenge that must be overcome. Not all the companies can work with recycled fibres (is necessary to align the recovery fibres), which is more complicated than working with virgin fibres. Furthermore, if we wish similar composites to those obtained with virgin fibres we need an almost perfect alignment, which is a difficult task to accomplish.

Despite these disadvantages, the high value of carbon fibre makes new companies arise all over the world. This is the case of the Institute of Textile Technology Augsburg (ITA) that employs recycled carbon fibres in combination with various thermoplastic matrix producing different types of non-woven.

The ITA has also implemented a production process of web based carbon fibre reinforced composites in its headquarters in Augsburg. It is a process that combines the thermoforming and subsequent compression with plastic injection. This process results in the production of final parts with mechanical characteristics comparable to those of metals.

This thesis that is presently exposed would have no meaning if it is not for two other thesis which have been carried out by my colleagues in parallel. Each segment of the process has been approached particularly by every author.

Miguel has focused on the preparation of preforms and his subsequent reduction of times, Gonzalo in the optimization of the robots cycle and Elias in the surface quality of the parts resulting from the process. Miguel and Gonzalo thesis are detailed in Bibliography with the references [Gar17] and [Die17] respectively.

But before focusing on each part it is necessary to have an idea of the general process. This process is encompassed in another larger process in which the treatment of recycled carbon fibre is present and also is its subsequent conversion into rolls of non-woven textile. This large process includes every practice from the recycling of carbon fibres to the production of final parts with a defined functionality.

In the image below a schematic representation of the distributions commented previously can be appreciated. On the left, a flowchart of the different segments treated by each author is displayed and on the right, a sector diagram of the whole process from carbon recycling to the production of parts is presented.

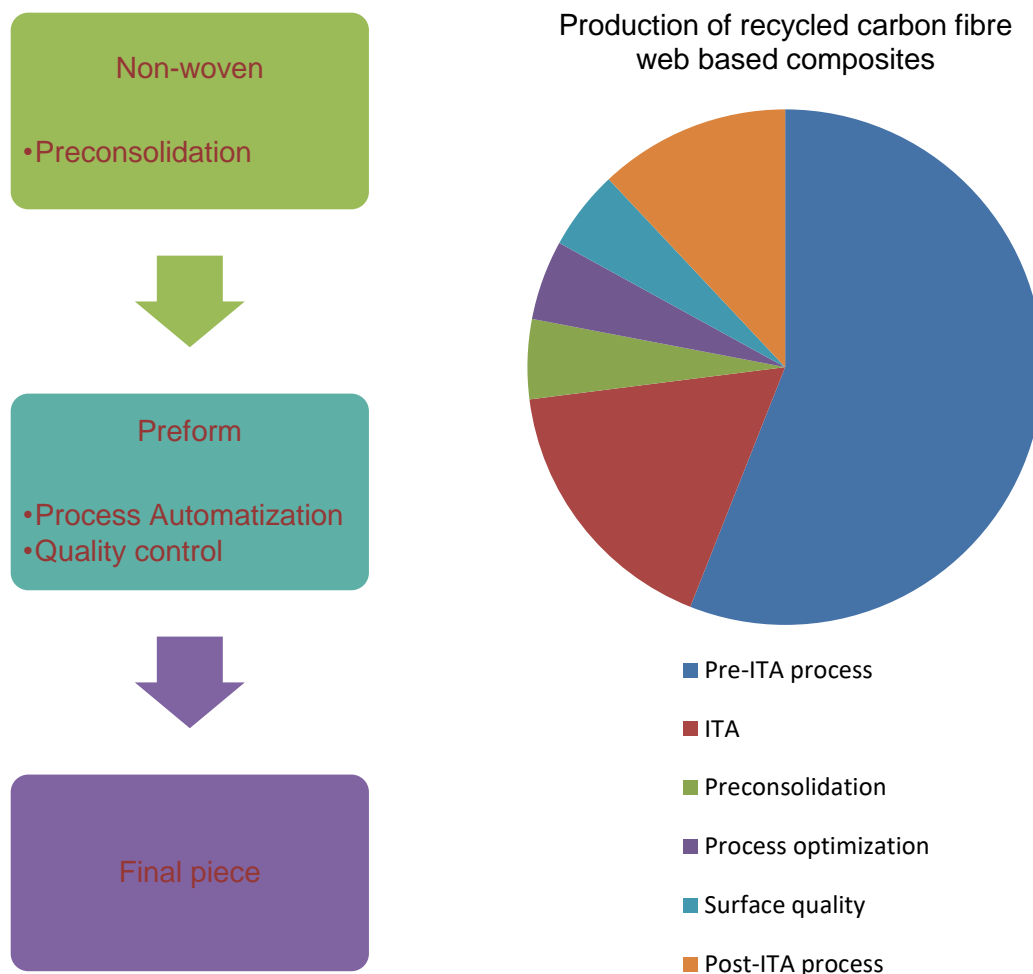

Fig. 1.1: Descriptive flowchart and sector diagram of the process.

The objective of this thesis is the improvement of the surface quality of the pieces produced in this automated process. For this purpose, a thorough study of the factors of the process influencing the surface quality of the piece was completed.

Since there were a large number of factors, several first trials were carried out on a segment of the process to determine the type of influence of certain parameters.

Later, with the results and conclusions derived from the previous trials, an experimental design applied to the entire automated process was performed. This experimental design had the aim to determine which of the factors affect the roughness value more.

Finally, on the basis of the results of the experimental design and the first trials small modifications in specific process parameters were made and subsequently, various final experiments were executed in order to get a smooth surface. These experiments took advantage of the results of the previous ones and aimed to get final pieces with good surface quality.

## 2 State of the art

### 2.1 Introduction to composite materials

Composite materials or composites arise as a response to the demand for new systems with properties that are impossible to assemble in a single type of material. There are requested materials that are resistant and rigid like the metals light like the polymers and simultaneously, resist high temperatures and corrosion as ceramics. Composites are multiphase materials that preserve, at least partially, the properties of its constituents, and are designed to present the most favourable combination of properties.

The use of composites is not restricted to a single field, although its greatest potential lies in the automotive and aerospace market, where the weight lightening of the different vehicles, together with the improvement of services of certain components submitted to wear, corrosion, or that work at high temperatures, has been, is and will be of particular interest to manufacturers in the coming years.

Composite material is intended to both obtain properties that cannot be achieved by any of the constituent parts acting alone, as bringing together the individual properties of these constituents in a single material. [M02]

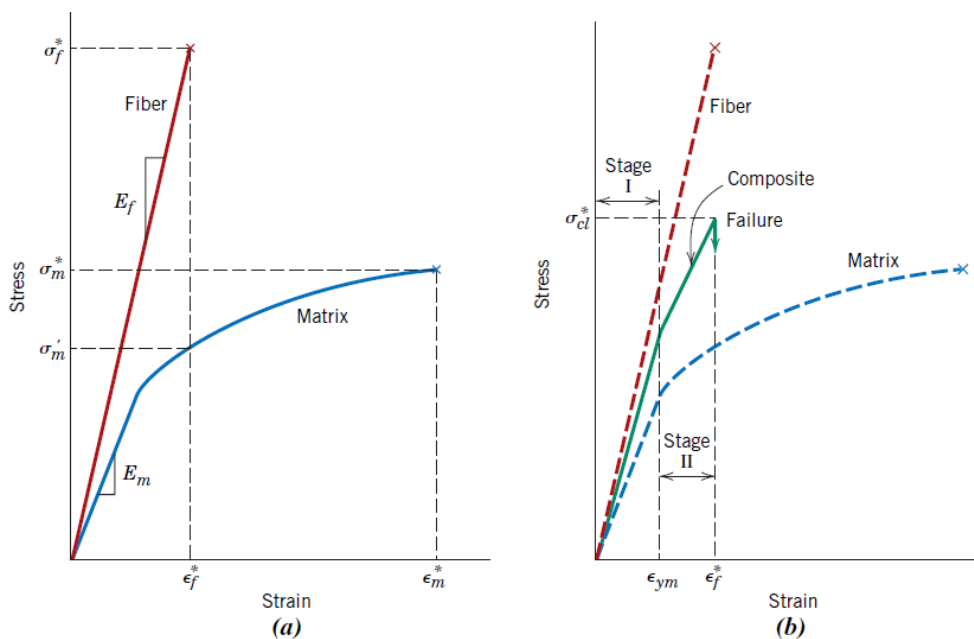

Fig. 2.1: Stress vs strain for fibre and matrix separated (a) and altogether (b). [CR14]

In Figure 2.1.a behavioural stress versus strain for fibres and matrix independently is represented and, to its right, in Figure 2.1.b the behaviour altogether, when they form a

fibre reinforced composite, exposed to a uniaxial stress applied in the direction of alignment.

$\sigma_f^*$  and  $\sigma_m^*$  are fracture strengths in tension for fibre and matrix respectively.

$\epsilon_f^*$  and  $\epsilon_m^*$  are their corresponding fracture strains, normally  $\epsilon_m^* > \epsilon_f^*$ .

A fibre reinforced composite formed by the union of fibre and matrix materials exhibits the stress-strain response illustrated in Figure 2.1.b.

In the diagram two stages can be appreciated, in the initial Stage 1, the matrix and fibres together become elastically deformed, so this portion of the curve is linear. The matrix deforms plastically at  $\epsilon_{ym}$  while the fibres continue to stretch in elastically because the tensile strength of the fibres is higher than the yield strength of the matrix.

After arrival at  $\epsilon_{ym}$  begins the Second Stage, this stage is usually linear but with a decrease of slope due to the proportion of applied load borne by the fibres increases.

The failure of the material begins when the composite reach the strain point of  $\epsilon_f^*$ , but this failure is not catastrophic for two reasons. First, not all fibres fracture at the same moment and, even after fibre failure, matrix is still intact due to  $\epsilon_m^* > \epsilon_f^*$ .

Therefore the fibres fractured, which are shorter than the previous ones are protected by the matrix and are also capable of sustaining a diminished load while the matrix continues to plastically deform.

## 2.2 Carbon fibres

### 2.2.1 Introduction to carbon fibres

In a graphite single crystal, carbon atoms are arranged in hexagonal arrays. Within the layers, basal planes are held together by strong covalent bonds with only van der Waals forces between them. Due to this, crystal units are anisotropic; the Young's modulus in the direction of the basal planes is about 1000GPa, while in the perpendicular is 35GPa. [H96]

Carbon fibres are between 5-10  $\mu\text{m}$  in diameter, consist of small crystallites of graphite. To obtain high axial modulus and strength, good alignment of the basal planes to the fibre axis is required.

### 2.2.2 Manufacturing process of carbon fibre

For the last years carbon fibre industry has firmly grown to satisfy the demand of the diverse applications that has carbon fibres. The field of carbon fibre applications depends on the precursor used to produce the fibres. The most frequent types of precu-



sors are used due to their simple conversion to carbon fibre, high carbon yield and economical processing. The subsequent three precursors are the most common used:

- Acrylic: for years they have been the most widely used by manufacturers and provides the best mechanical properties for its application in the manufacture of composite materials. They contain more than 85% of acrylonitrile monomer. Especially polyacrylonitrile (PAN) is the most employed to produce carbon fibres.
- Cellulosic: they contain 44% carbon and the carbon yield varies between 25-30%.
- Pitch-based: they have a yield of 85% but compression and transverse properties are inferior to the ones obtained by PAN.

Figure 2.2 schematically represents the carbon fibre production process from PAN-based precursors. The process is essentially summarized in: polyacrylonitrile polymers are heated through a multiple process so that the molecules combine, forming more complex structures by the effect of the heat. Finishing the process, structures are wider and most of the nitrogen contained in the initial PAN polymers has been released, obtaining a structure formed almost by pure carbon in its graphite form.

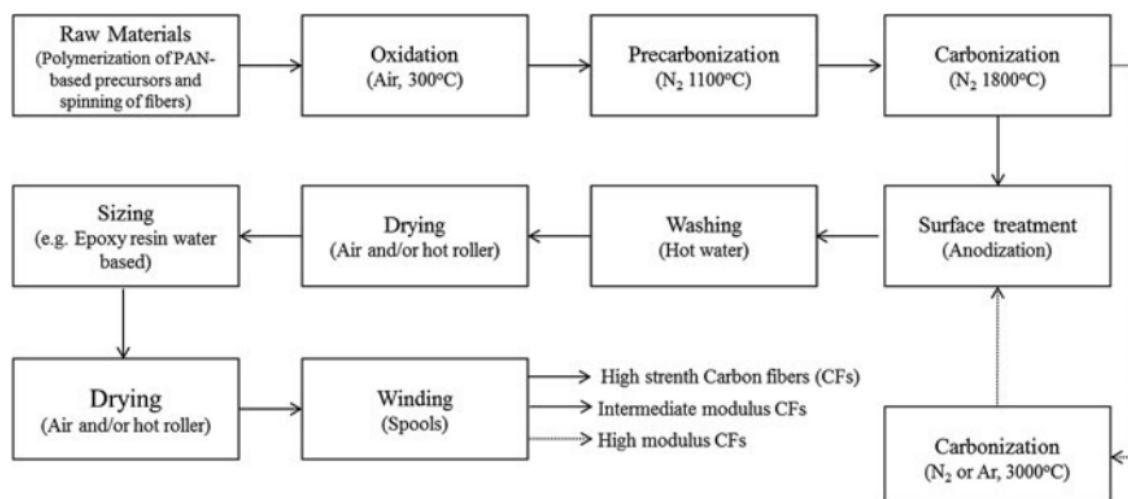

Fig. 2.2: Simplified representation of manufacturing process of carbon fibres from PAN precursors. [PH10]

### 2.2.3 Properties of carbon fibres

The best mechanical properties of carbon fibres are obtained by associating them with epoxy type matrix. One of the most interesting features of them is its thermal expansion coefficient; negative in the fibres direction and positive in the transversal direction. Therefore, using an appropriate combination of matrix and reinforcement, it is possible to obtain a material that does not suffer thermal deformations in a wide range of temperatures (material with high dimensional stability). [A05]

In addition to this particular feature, the following properties can be highlighted: [www09]

- 
- High strength (Specific strength of 0.7-2.7 GPa).
  - High rigidity (106-407 GPa of Young Modulus).
  - Low density (1.5-1.7 g/cc).
  - High resistance to vibrations
  - Good behaviour to fatigue (1600 MPa).
  - Good electrical conductivity (Electrical resistivity of  $1.5-7 \cdot 10^{-4}$  ohm cm).
  - Good thermal conductivity (24 W/mK).
  - Low thermal expansion coefficient (-1 to +8 Inch / inch degree F).
  - High temperature resistance (Fire resistance and non-flammable).
  - Chemical stability
  - They resist sea conditions
  - Non-poisonous, biologically inert and X-Ray permeable.

#### **2.2.4 Types of carbon fibres**

Depending on the final temperature reached in the heating process (from 1200 °C to 3000 °C) one can distinguish different types of carbon fibre: [A05]

- Fibres of high tenacity (HT): better resilience and tenacity than glass fibres but less than the rest of carbon fibres. Its cost is moderate, and they are used in a wide range of applications.
- Fibres of high modulus (HM): they have high rigidity and a very high elastic modulus. They have a high cost and are used mainly in the aerospace field.
- Intermediate modulus (IM): they are an intermediate fibre between HT and HM.

### **2.3 Recycling of composites**

#### **2.3.1 The need of recycling**

Today there is a clear need to recycle composites used in recent decades as the recycling technologies were not fully developed previously. By recycling, we recover material of great value, and collaborate with a more sustainable environment.

The cost of the carbon fibre is one of the impediments to its more general use. The demand for this product is increasing year by year and is expected to double in the year 2022, as can be seen in the following graphic (Figure 2.3). [SGG16]

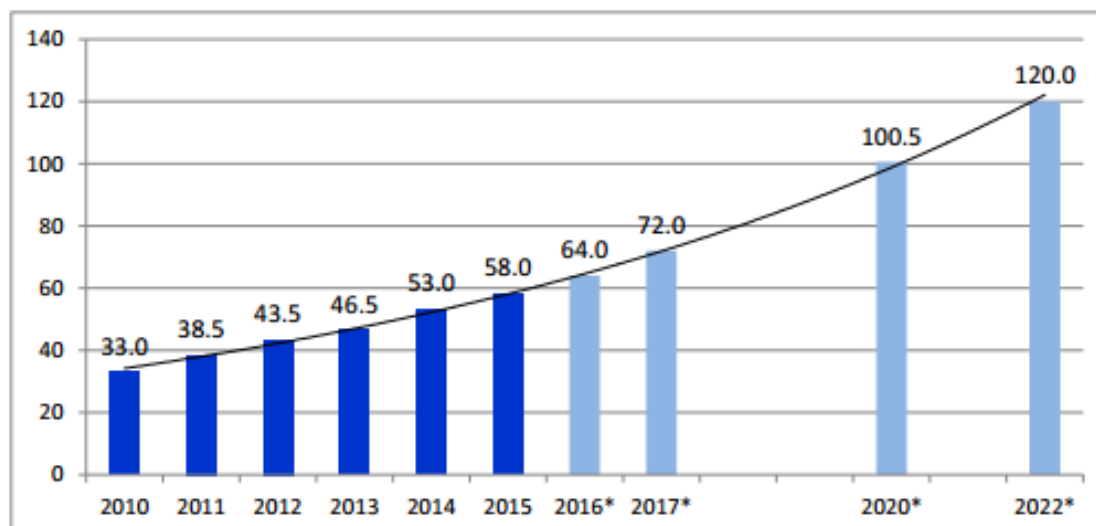

Fig. 2.3: Global demand for Carbon fibre in 1,000 tonnes 2010 to 2022 (\*Estimation).

Because of this carbon fibre recycling takes importance, as the planned production capacity of different plants that are dedicated to produce carbon fibre for sale, and the new ones expected to be created, its believed that will be unable to satisfy the estimated demand.

This is reflected in the Table 2.1, where in 2020 could have a shortage of 27kT, so that the recycling of carbon waste is a solution of this problem. In addition, as the use of carbon fibres grows each year, the availability of raw material for recycling also increases. [A16]

Tab. 2.1: Carbon fibre supply and demand. [A16]

Year	Nameplate capacity (kT)	Effective capacity (kT)	Expected demand (kT)	Spare capacity (kT)
2012	109	65.3	44	21.3
2014	125	79	53	26
2020	191	115	103 to 142	12 to -27

### 2.3.2 Legislation

The European Waste Framework Directive (2008/98/EC) sets the basics and the definitions in regard to waste management. Basically it applies the principle “who pollutes pays” and it is based on an inverted pyramid of 5 divisions and on the top of it resides “Disposal”.



Fig. 2.4: Pyramid in regard to waste management. [SGG16]

The emissions target for passenger vehicles establish a limit of 95 g CO<sub>2</sub>/km for emissions, averaged across a manufacturer's production by 2020. [Reg14]

This objective is difficult to achieve only through improvements in the engine or aerodynamics. In this environment becomes important weight reduction and with it, the use of composites. Moreover, the End of Life Vehicle Directive (ELV) requires that a 95 per cent by weight of vehicles be reused, recycled or recovered. [LVD00]

Carbon Fibre Reinforced Plastics (CFRP) can be an alternative for their great lightness, but their high cost and the lack of practicable recycling methods are still an impediment for the automotive industry. [McK12]

### 2.3.3 Thermoplastics and thermosetting plastics

The matrix phase of a composite material has several functions. First, joins the fibres and acts as a medium that distributes to the fibres the applied external efforts. Secondly, the array protects the fibres of the superficial deterioration (impacts, abrasion, corrosion...). Finally, the matrix separates the fibres and prevents the propagation of cracks so that, although some fibre breaks, the composite does not break until a large number of them have broken. [CR14]

Carbon fibres are used to reinforce various types of matrix. We will mainly focus on carbon fibre reinforced plastics (CRP). The polymer matrix used can be divided into thermoplastics and thermosetting plastics, being the last ones the most commonly used due to its advantageous characteristics, for example Polyester: [R99]

- Good mechanical properties (tensile modulus  $1.1 \pm 0.2$  GPa, tensile strength  $40.6 \pm 4.9$  MPa, impact strength  $62.6 \pm 11.5$  J/m and elongation at break  $5.1 \pm 1.2$  %).
- Good temperature resistance (heat distortion temperature 71 °C and melt temperature 250 °C).
- Low moisture absorption (rate of water absorption (%) 0.02-0.05 at 20 °C).
- Great choice of matrix systems and production processes.

Thermoplastics were often omitted in the past because their poor capacity to wet the fibres. On the other hand, they apparently have better properties, for what will be extensively used in the future. Some of the most remarkable are, for example Polypropylene (PP): [R99]

- 
- Lower processing times than thermosetting plastics.
  - Acceptable mechanical properties (tensile modulus 2.28-3.28 GPa, tensile strength 35.9-51.7 MPa, Yield Strength 25.0-69.0 MPa and elongation at break 1.2-2.5 %).
  - Good resistance to impact (failure mode ductile).
  - Easier formed and welded than thermosetting plastics.
  - Problem free storage
  - Easier recyclable than thermosetting plastics.

Within a certain temperature range thermoplastics can be melted or heated because their shape is not an irreversible process. Therefore, materials with a thermoplastic matrix are easier to recycle without damaging the fibres with high temperatures. In thermoset composites the recycling is more complex and the matrix has to be decomposed, process that only can be done with high temperatures (pyrolysis) or chemicals (solvolysis).

### 2.3.4 Recycling processes

The chemical process (solvolysis) is based on the following principle: a solvent or mixture of solvents is used to reduce the matrix into chemical compounds of lower molecular weight, leaving carbon fibres separated from the matrix. It's a process with a great variety of possibilities due to the wide range of solvents, catalysts and conditions that can be introduced. [H14]

Pyrolytic processes work with a range of temperatures that varies normally between 450°C and 600°C depending on the type of matrix and the atmosphere used. It is a process that allows the recovery of fibres, fillers and inserts. The matrix is split into molecules of lower weight and as a result of the process gas and oil are obtained. These waste products are frequently burn to recover energy. [A16]

There is a reduction of the strength of the fibres between a 4 and 85% depending on the conditions of the process. If the conditions are meticulous fibres with mechanical properties similar to the original ones can be obtained. [A16]

The environmental impact of the different methods of recycling is determined by the demand of energy. Normally, electricity is the main source of energy in these processes. The reduction of electricity is important to improve the processes and for the environmental sustainability. The figure 2.5 graphically represents the specific demand of energy in the various methods of recycling. You can appreciate clearly that the diverse processes differ a lot in which in terms of energy is concerned.

Pyrolysis and chemical processes have a commercial basis. For regular pyrolysis process claimed power varies between 24-30MJ/kg. Within the pyrolytic processes, Microwave pyrolysis is the most energy efficient thanks to the fast and selective heating.

The Mechanical process is a recovery process in which the material is ground in a hammer mill and divided into diverse fractions, that later can be sieved into powder. It

is a technique typically used with GRP (Glass Reinforced Plastics) and because of that, I have not discussed in the previous paragraphs.

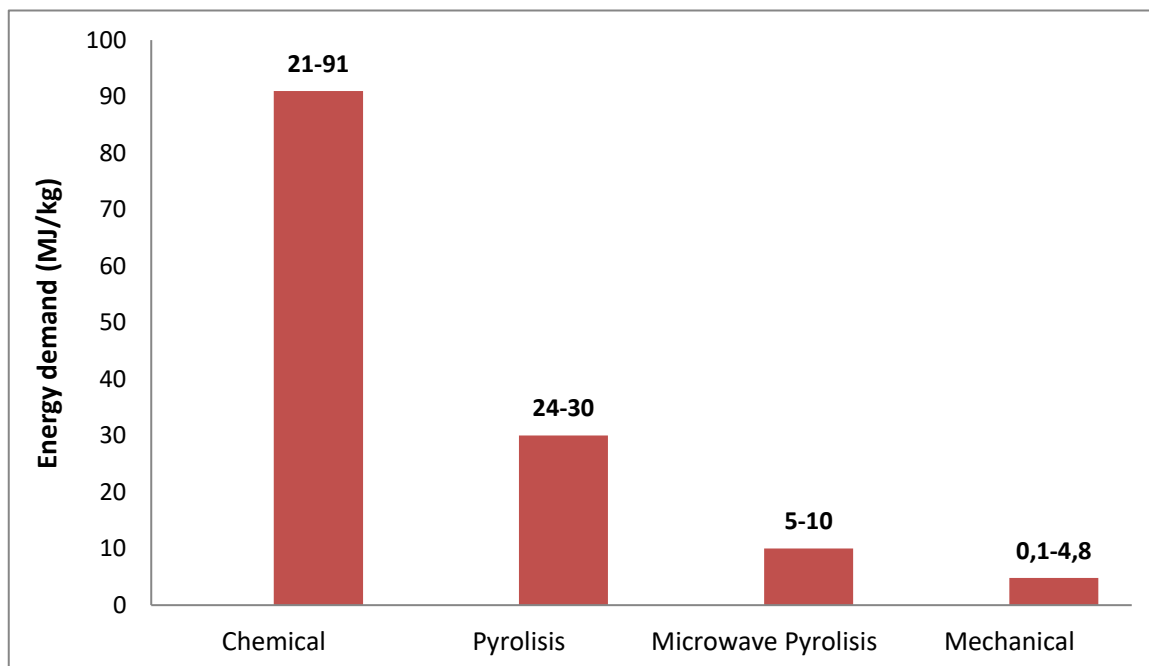

Fig. 2.5: Energy demand in composite recycling methods. [SGG16]

However, the recycling of composites is not only important to ensure the annual demand of this product. In addition, it also favours the conservation of the environment. As we can observe in the figure 2.6, the energy difference between the production of virgin and recycled carbon fibres is considerable. The energy demand of the recycling processes can be up to 20 times lower. [SGG16]

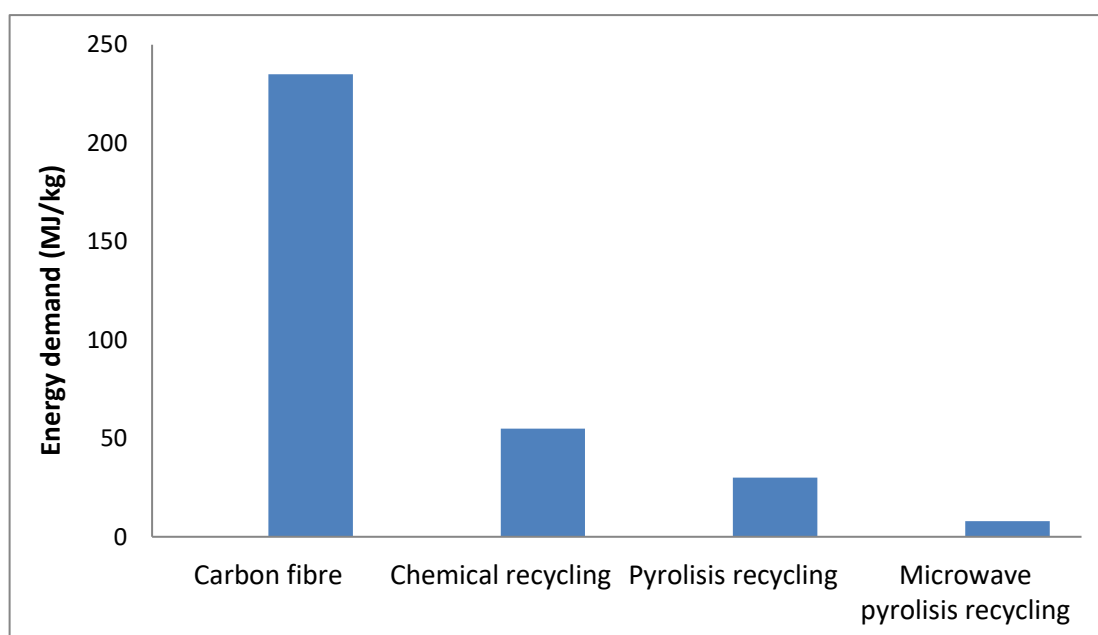

Fig. 2.6: Energy contrast between production and recycling carbon fibre processes.

Whatever the process used, all processes require that the raw material is reduced in size to be processed. At this time there are fibres of different lengths and discontinuous aligned fibres. Subsequently these loose fibres are converted in a material employable for the composite industry. The easiest way is to chop the fibre and grind it to produce milled fibre, which are very short fibres typically 0.1 mm long. [A16]

Nevertheless these fibres are yet very short, lower than the critical length and the reinforcement effect is diminished.

### 2.3.5 Critical length of fibre

The critical length of fibre is an important parameter in the design of composites. Figure 2.7 shows diagrams stress-position produced by applying an effort to a fibre with the critical length (a), greater than the critical (b) and less than the critical.

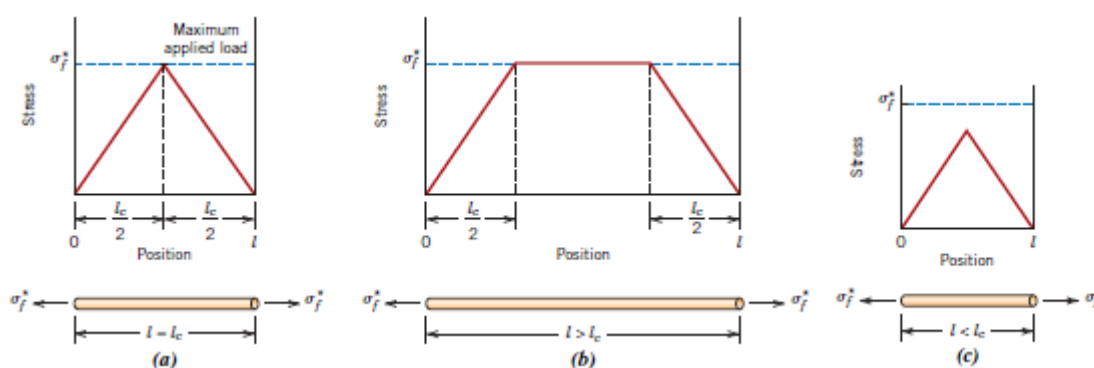

Fig. 2.7: Stress-position depending on the length of the fibre. [CR14]

When a stress equal to  $\sigma_f^*$  is applied to a fibre whose length is the critical, the stress-position graphic is shown in Figure 2.7 (a), the maximum fibre load is achieved only at the middle of the fibre. With the increment of fibre length  $l$ , the reinforcement becomes more powerful. On the other hand if the length is lower than the critical the matrix deforms around the fibre and there is little reinforcement. [CR14]

Longer fibres are suitable for traditional textile procedures (cotton, wool). These fibres are introduced as discontinuous fibres and convert into textiles. At ELG Carbon Fibre the recovered carbon fibres are chopped into staple and then carded to produce a nonwoven needlefelt. Some amount of thermoplastic fibre can be added to these felts and produce "hybrid mats".

The loose fibres are fed into a carding drum, the dosing of the fibres is done gravimetrically to achieve uniform properties. Then the carding machine teases the fibres out to form a web. Subsequently, this web is laid up on a cross-lapper for building up the desired weight of textile. Finally, the layers are consolidated by a needle loom to produce the finished needlefelt. [A16]

## 2.4 Matrix

As it was mentioned in the 2.3.3 point the matrix phase of a composite joins the fibres and acts as a medium that distributes to the fibres the applied external efforts. Also protects the fibres of the superficial deterioration and separates them and prevents the propagation of cracks.

Carbon fibres are used to reinforce various types of matrix. Some of the most commonly used include polyamide and polyester. Polyamide receives more importance because it is the one that we will employ in this thesis.

### 2.4.1 Polyamid

Carbon fibre polyamide composites are in the field of the composites of great interest in the automobile sector with the short term goal of replacing metal in many components and products due to the abundant enhancement of properties such as stiffness and strength with weight reduction.

In fact there are certain variants of polyamide with a great degree of heat resistance that are being incorporated in car engines. Certain components inside the engine historically made of metal are being replaced by composites, for example engine covers or cylinder head covers. [TR11]

Table 2.2 shows the properties of polyamide 6 (PA6) together with the ones of polyester resin for comparison. In this table can be appreciated that both of them have similar properties except for the yield stress and the impact strength. The yield stress of polyamide improves the one of Polyester and the opposite happens with the impact strength:

Tab. 2.2: Properties of polyamide and polyester. [RLL11]

Property	PA6	Polyester
Tensile modulus (MPa)	3400	3500
Yield stress (MPa)	90	50-80
Yield strain (%)	10	3-6
Impact strength (KJ / m <sup>2</sup> )	4	15

Despite the good mechanical properties, its inclination to absorb moisture from the environment is an important disadvantage. Polyamide absorbs more moisture in comparison with other thermoplastics.



Table 2.3 shows the difference in properties between dry polyamide and under standard conditions (23°C and 50% RH)<sup>1</sup>.

Tab. 2.3: Influence of water content on polyamide. [RLL11]

Property	PA 6 Dry	PA6 conditioned 23°C and 50%RH
Tensile modulus (MPa)	3400	1200
Yield stress (MPa)	90	45
Yield strain (%)	10	>50
Impact strength (KJ / m <sup>2</sup> )	4	50

Moisture, which can be absorbed during storage and use, affects a wide range of properties, which are very sensitive to liquid as is shown above.

## 2.5 Nonwoven

### 2.5.1 Concept of nonwoven

Definition by EDANA, (The European Disposables and Nonwovens Association) and INDA, (North America's Association of the Nonwoven Fabrics Industry): [SJ07]

EDANA: "a nonwoven is a manufactured sheet, web or batt of directionally or randomly orientated fibres, bonded by friction, and/or cohesion and/or adhesion".

INDA, "is a sheet or web structures bonded together by entangling fibres or filaments, by various mechanical, thermal and/or chemical processes. These are made directly from separate fibres or from molten plastic or plastic film."

The proposed definition by EDANA and INDA to the International Standardization Organization (ISO) is: [SJ07]

*"A nonwoven is a sheet of fibres, continuous filaments, or chopped yarns of any nature or origin, that have been formed into a web by any means, and bonded together by any means, with the exception of weaving or knitting".*

<sup>1</sup> According to the ISO standard (EN ISO 1110) the equilibrium moisture content attained by conditioning specimens at 70 °C and 62% RH is close to the equilibrium moisture content obtained in the standard atmosphere (23 °C and 50% RH).

Organic sheets can be laid up and employed as shown in Figure 2.8:

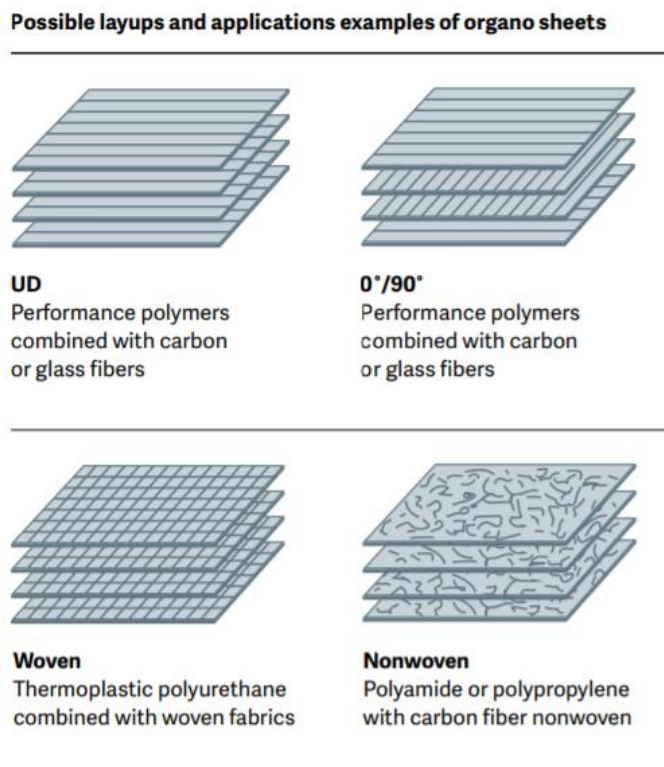

Fig. 2.8: Possible layups and applications examples of organic sheets. [SGL17]

Nonwovens are engineered fabrics made from fibres; these fabrics can be a limited life, single-use fabric or a very durable fabric.

This high-tech unique fabric has some characteristics that allow them to be use in a wide range of applications, which are: absorbency, liquid repellence, resilience, stretch, softness, strength, flame retardance, wash ability, cushioning, filtering, bacterial barrier and sterility. [SJ07]

Having such a wide range of applications the nonwoven can be combined to create specific fabric for very specifics jobs, all this while maintaining a good ratio between the product life and the cost.

The nonwoven can be divided in three main categories drylaid, wetlaid and polymer-laid, the drylaid materials have their origins in textiles; the wetlaid materials have theirs in papermaking, and the polymer-laid products in polymer extrusion and plastics. In this thesis drylaid is the only being discussed because of its importance in textiles. [SJ07]

## 2.5.2 Dry-Laid

There are two methods of manufacturing dry-lay nonwoven:

**Carding:** This is a mechanical process in which the bales of fibres are open. Then these fibres are combined into a web by a carding machine. When the web is being

carded the fibres can be parallel-laid or random-laid. When the fibres are parallel-laid carded the resulting web has good tensile strength, low elongation and low tear strength in the machine direction but low properties in the in the cross direction.

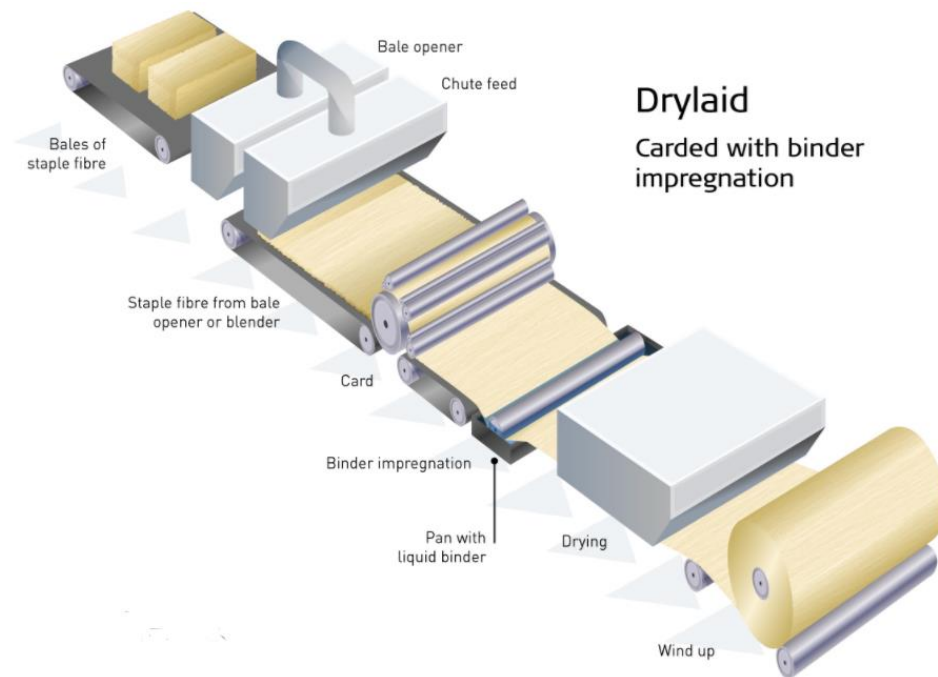

Fig. 2.9: Diagram of the carding process. [ED17]

Airlaying: using this process we form a randomly oriented web. The process starts feeding the fibres, in some cases very short, into an air stream. Then the fibres are randomly laid by a moving belt or perforated drum.

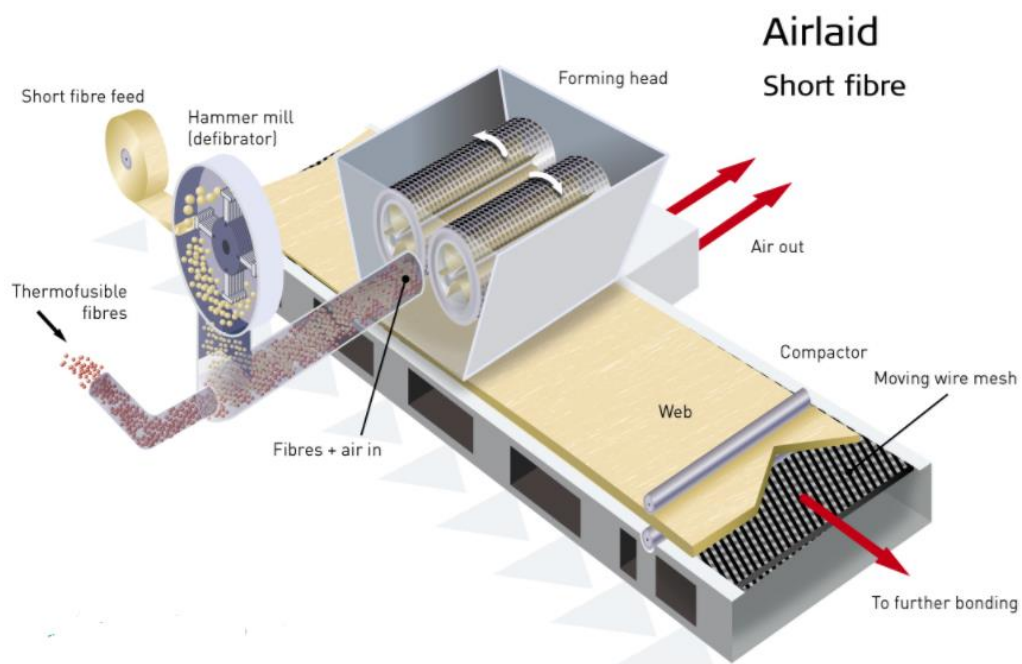

Fig. 2.10: Diagram of the airlaid process. [ED17]

Airlaid webs have a lower density, a greater softness and an absence of laminar structure compared with carded webs. This method also expands the range fibres and fibres blends that can be used.

The webs created using airlaying and carding method have little strength in their unbonded form; therefore we must strengthen the web.

This process is called bonding and it is a crucial part of the production of nonwovens. Depending on the type of bond strength we apply to the web we get different functional properties.

There are three basic types of bonding, chemical, thermal and mechanical.

- Chemical: In this method, bonding mainly refers to the application of a liquid based bonding agent to the web.
- Thermal: This method uses the thermoplastic properties of certain synthetic fibres to form bonds under controlled heating
- Mechanical: In this method, the friction created by the interaction of the fibres is used to strength the web.

This different method can be further personalized to meet the customers' demands by using different chemical substances before or after the binding, also different mechanical process can be used to the nonwoven after the binding. [ED17]

### 2.5.3 Dilo compact system

Through recycling, it is very difficult to get similar fibres to the originals because at the end of the process we obtain non-continuous aligned fibres with different lengths. Many of them are also damaged by the effect of high temperatures or chemicals.

As a result, some recycling companies have focused on producing intermediate outputs for different production processes. This is the case of textiles and preforms in general and of the "ITA" in particular. In fact, "ITA" can produce different types of nonwovens using a Dilo system for its purpose. This system is illustrated in Figure 2.9.

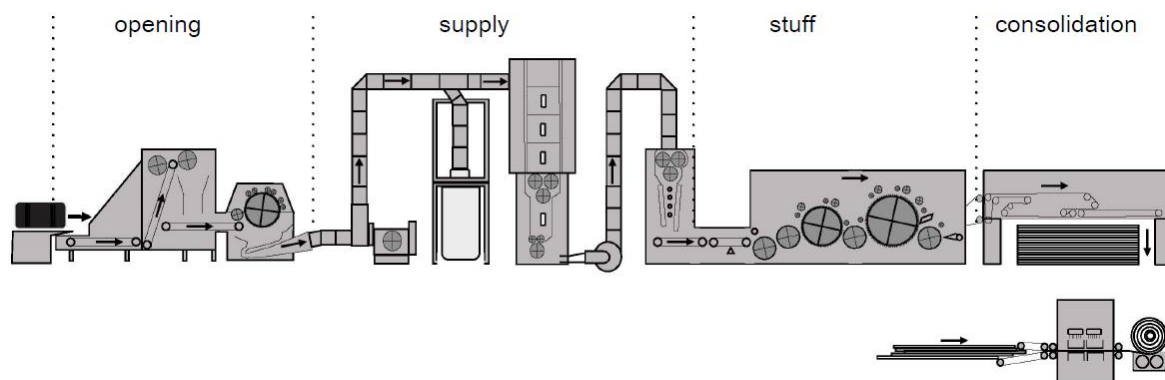

Fig. 2.11: Diagram of Dilo system for nonwoven production. [Mar17]

## 2.6 Component production of carbon fibre

The development of inexpensive and fast manufacturing processes has been and is an objective. Highly complex components with very short cycle times are already known for injection processes. However, until now only short-fibre reinforced thermoplastics have been used in serial applications. The main objective is to achieve short cycle times with continuous-fibre reinforcements, whose mechanical properties are better.

Therefore, the following processes for continuous fibre reinforced components are considered.

### 2.6.1 Thermoforming of organic sheets

Organic sheets are continuous fibre-reinforced, semi-finished products, embedded in a thermoplastic matrix. One of the most used matrix is polyamide, apart from other advantages, especially allows a very good adhesion to fibres. First, the organic sheet is heated to give shape by thermoforming. Subsequently, this product is heated to a temperature close to the fusion point of the matrix and immediately afterwards, is placed in a mould and is compressed into shape. Here, it must be ensured that there are no dislocations of the fibre layers. The entire cycle can last about 60 seconds conceivable for the quick processing potential of thermoplastics. [RAR12]

Figure 2.12 characterizes the process in terms of physical shape change and thermal variation of the blank during the complete process.

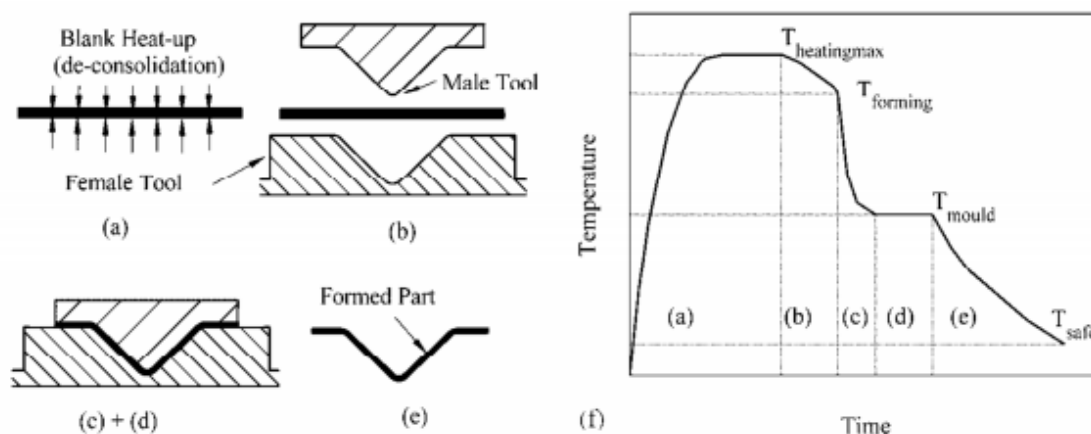

Fig. 2.12: Key stages in the thermoforming process for reinforced thermoplastic composites. [RAR12]

### 2.6.2 Resin transfer moulding

It is the process of producing composites in a mechanically closed rigid mould. Dry reinforcement (glass fibre, carbon fibre, aramid, etc.), is positioned between the two sides of the mould, and this is closed using mechanical forces (hydraulic press, bolts or vacuum). [RT17]

A thermosetting resin is injected, often by the central part of the mould, directly in the reinforcement fibre bundle. The mould is filled by the effect of the hydraulic pressure generated by the injection machine. The mould has normally outputs at the corners, allowing air from the inside to escape and being replaced by the resin.

Vacuum resin transfer moulding (VRTM) is a variant of RTM which principal difference is that makes use of the atmospheric pressure as help to close the mould, in contrast to the heavy locking systems used in RTM. [VI17]

### 2.6.3 Thermoforming and injection moulding

It is a process that combines the thermoforming and subsequent compression with plastic injection. This is a process used by the “Institut für Textiltechnik Augsburg” (ITA) with an Engel 1050H 200 machine.

In an automated cell, individual organic sheets are pre-heated by an infrared oven, inserted into an injection mould by means of a robot with hydraulic needles. It is then compressed and back-injected with ribs. In figure 2.13 you can see a diagram illustrating this process. [Kra17]

The use of injection molding also makes it possible to work in thermoplastic with long fibre reinforcement and thus to achieve components with greater strength. The high pressure with which the melt is initiated, permits that possible imperfections in the composite sheet can be filled. [PT12]

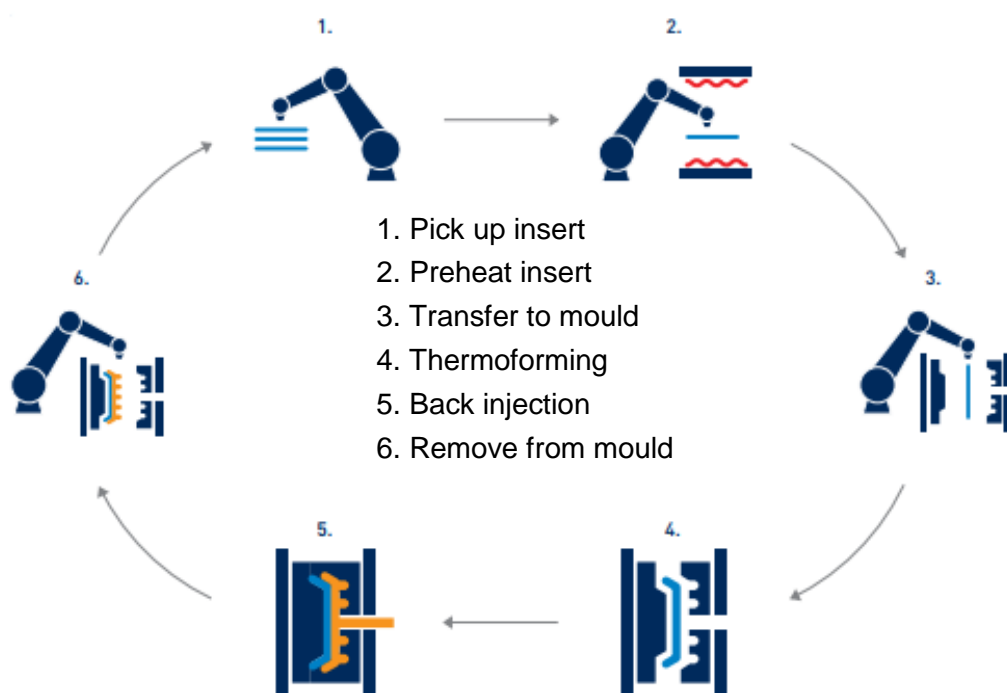

Fig. 2.13: Step process of thermoforming combined with injection moulding. [Kra17]

### 3 Production process

As it was mentioned in paragraph 2.6.3 the production process of parts consists of several steps. In the first place, preforms, which are the raw material for the process, are obtained. This preforms consist of the union of different layers of nonwoven. This union is possible by submitting the layers to heat and pressure with a stamping machine.

Later, these preforms are heated to the melting point of the matrix in an induction furnace. When they reach the melting temperature, a robot transports them to the mould holding them by the top via a needle group.

Then the mould is closed and the press allows the preform to get the mould's shape. At this time, the injection unit injects plastic on the low side of the mould culminating the thermoforming and injection moulding entire process.

Finally, the press opens allowing collecting the final composite piece and ending a process cycle.

The process described above is schematically represented in Figure 3.1:

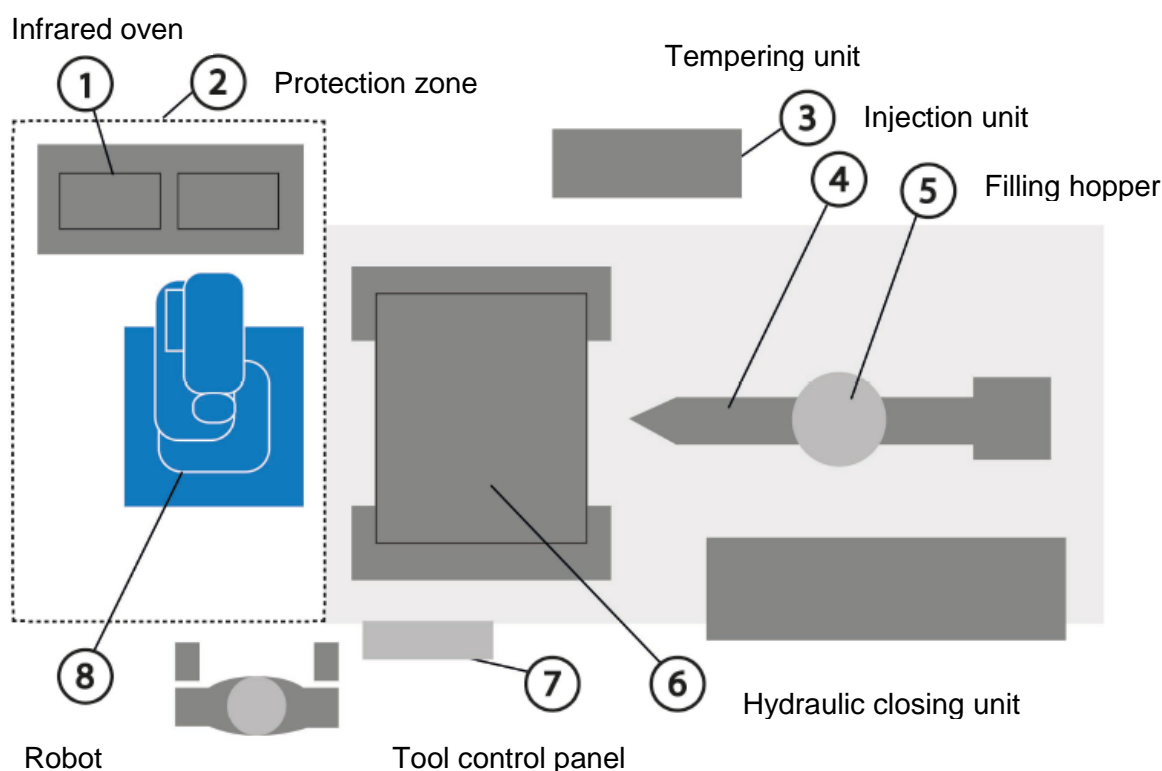

Fig. 3.1: Top view of the manufacturing process. [Ege17]

### 3.1 Infrared oven

This is an element of great importance because it provides the necessary heat to melt the preform before introducing it into the mould.

The handling system leaves the preform on a tray. Then the tray retracts back into the oven where the fusion of the thermoplastic material takes place. After that the tray extends out of the oven and the preform is seized by the handling system and placed in the mould.

The temperature of the oven is a parameter that influences in the superficial quality of the final piece and therefore, will be dealt with in detail further on.

Figure 3.2 shows the oven employed in the experiments and its principal components.

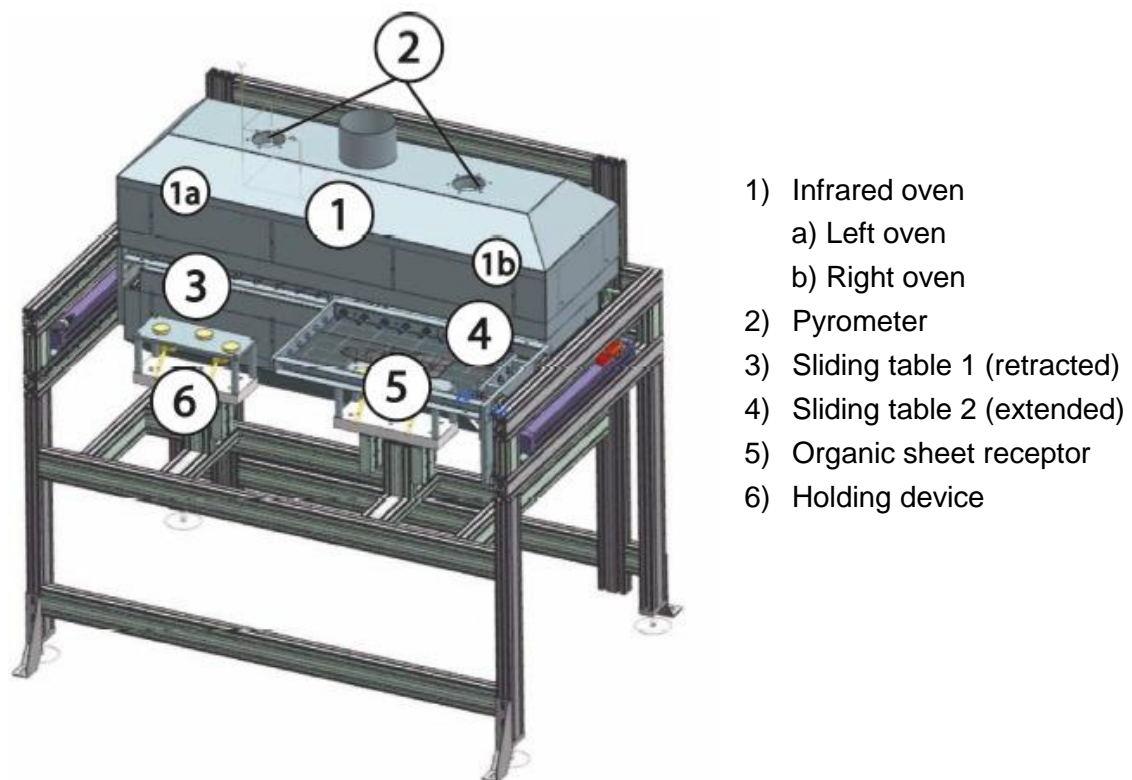

Fig. 3.2: Infrared oven and its components. [EnM16]

### 3.2 Handling system

The handling system is a robot from the company Stäubli AG, Pfäffikon, Switzerland with an Engel control software for operating. This robot consists of six axes controlled by servomotors. The acquisition-head is driven by a pneumatic system with compressed air.



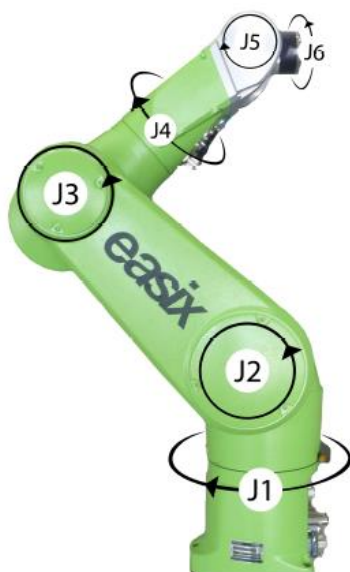

Figure 3.3 illustrates the robot and the movements that can perform.

At the top a head is fitted which is responsible for holding the workpiece when the robot is transporting it.

As will be seen later, the handling system has relevance in the thesis since it affects the surface quality of the workpiece.

A group of needles is responsible for providing the stability during movement, getting inside the piece with a certain angle to avoid the gravity effect.

Fig. 3.3: Staubli robot and its rotation axes. [EnM16]

The needle group commented previously is shown in figure 3.4



Fig. 3.4: Image of the needle group in detail (extended position).

There is a second pneumatic circuit which work as a vacuum ejector, since they are used to remove the pressed piece from the mould. This second holding unit is required because once the moulding process has finished, the final piece is below the melting temperature of the array and the needles cannot penetrate it.

An image of this second holding unit is attached below in figure 3.5.



Fig. 3.5: Image of the second holding system with vacuum circuit.

### 3.3 Pressing unit

The PRESSING unit is responsible for the injection moulding process. It ensure a tight sealing of lower and upper parts of the mould, holding the injection pressure and providing the final piece the desired shape.

The upper and lower mould halves can be heated separately. This is necessary to prevent a quickly cooling of the molten preform and to allow a good impregnation of the web with the melted thermoplastic during the compression phase.

In figure 3.5 the pressing unit is represented. Down to the left is the pressing half on the right the injection half. Up in the middle resides the heating tool.



Fig. 3.6: Pressing unit opened with the pressing and injection moulds.

### 3.4 Induction unit

This is an induction equipment composed by an “IFF” generator, together with water-cooled special inductors, enables the extremely energy-efficient preheating of metallic components in very short times. In the end, the unit is connected to two ferromagnetic steel plates whose main task is to provide energy in the form of heat to the upper mould.

This unit allows the possibility to heat the top of the mold without having to elevate the oil from its interior at high temperatures in which the electrical expenditure is very high in comparison with the plates whose efficiency is about 75%.

In addition the mould dissipates a lot of energy because it is not isolated from the environment and it is not viable in terms of energy waste to heat the oil to the desired temperatures.

In figure 3.7 an image of the induction plates is presented. The induction plates are collocated above the needle group hast at the end of the robots head.

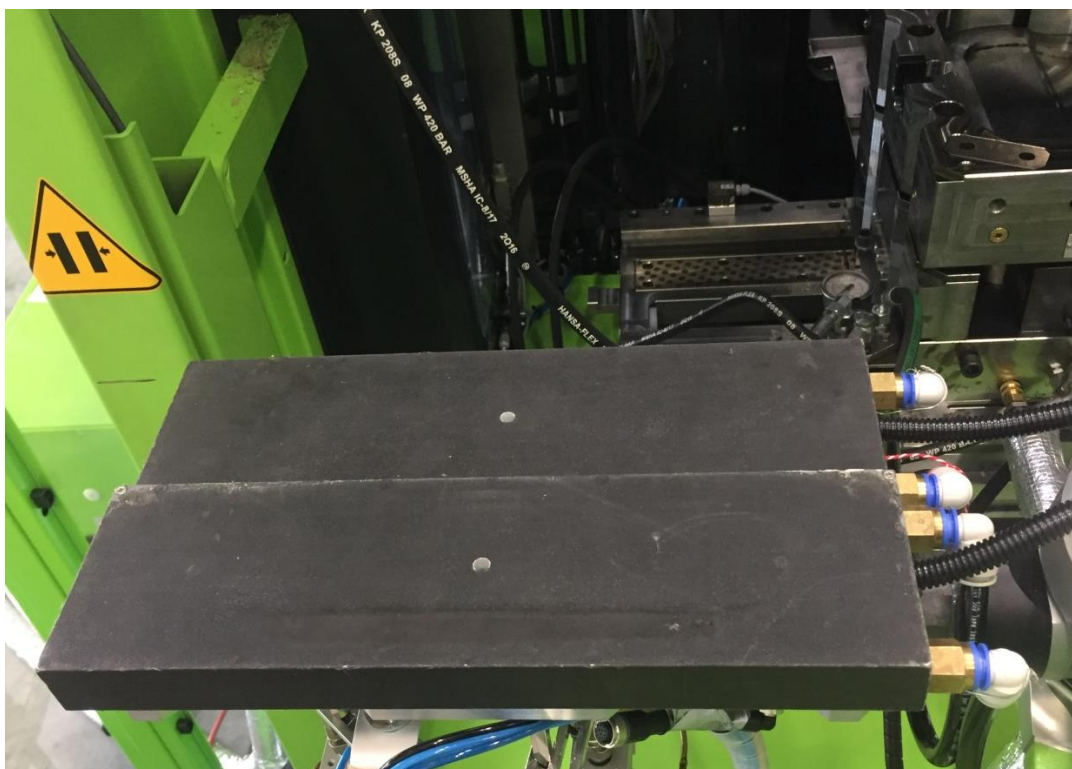

Fig. 3.7: Plant vision of the induction plates.

---

## 4 Preparation of the experiments

### 4.1 Objectives

The objective of this thesis is to improve the surface of the pieces obtained through the thermoforming of web based composites.

There are a large number of factors that influence the final surface of the piece; some of them are fixed parameters in the process, that is, parameters that cannot be modified as the material of the mould, the atmosphere or the needle group in charge of holding the piece during its way through the productive process. Others, however, can be modified and it is in them on which we will focus our attention. Some of these are furnace and mould temperatures, the composition of the web, the introduction of polyamide or not, the process employed for obtaining the preform, etc.

Several trials will be held at the beginning in specific segments of the process to determine the influence of certain parameters and to understand how they affect the final piece.

Subsequently, an experimental design will be applied to certain parameters to determine which of them affects the final quality of the piece.

Finally, the information collected in the diverse tests will be used to modify the different parameters in order to improve the surface of the final part.

### 4.2 Preparation of the preforms

The raw material was provided, in the form of nonwoven rolls, by the ITA, which used for its creation a compact non-woven line.

From these rolls, preforms were obtained by cutting the material with the shape of the mould. Subsequently, for the creation of the final web a process recommended by Miguel, whose thesis is about improving the process of obtaining preforms, was followed.

This process consists in the union of four different layers of web using a manual heating press "DEMA Hand-press TP1400" and followed by a cooling under pressure.

An explanatory flowchart of the process with temperatures, times and weight is shown in the Figure 4.1

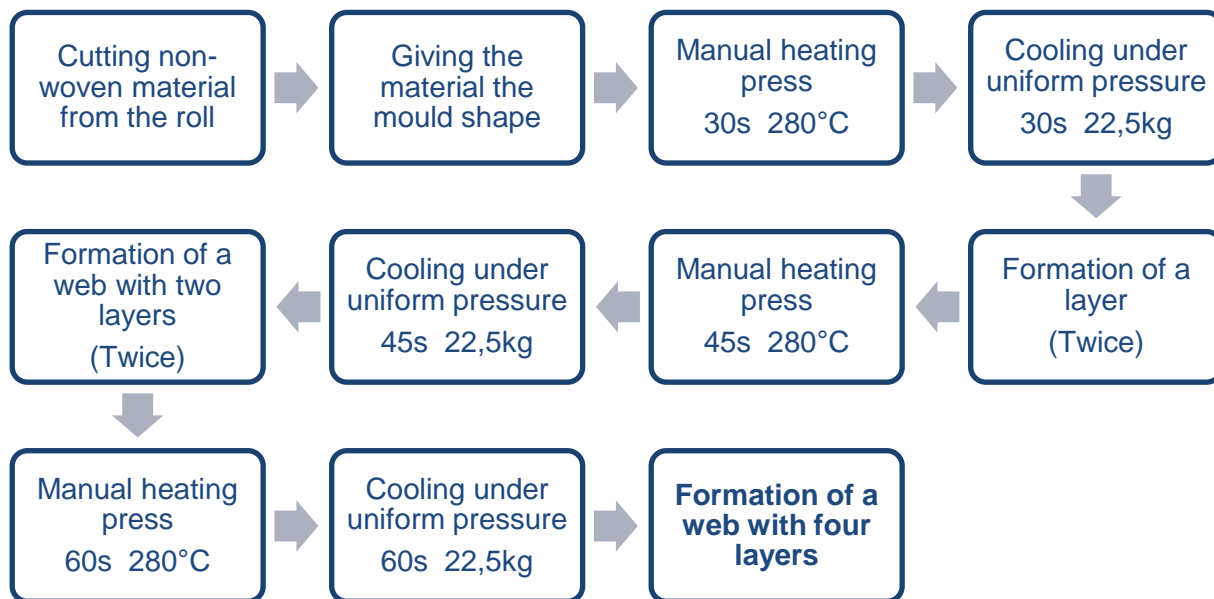

Fig. 4.1: Flowchart of the web preparation process.

### 4.3 First trials

During the early part of the thesis first experiments were carried out to determine the impact of needle group on the surface of the piece. These experiments were performed with the help of the robot and the furnace and consisted in the variation of certain parameters in a pre-defined process.

For these first experiments non-woven webs composed of 40% CF 60% PA and 680 g/m<sup>2</sup> of density was used.

These parameters were:

- Number of layers of the web
- Different web creation processes
- Temperature of the web surface when leaves the oven
- The insertion of polyamide or not
- The speed of the robot
- The movements of the robot

The predefined process consists of an automatic process in which the robot takes the piece of a dispenser with the help of the needle group. Afterwards, it carries the web to the furnace where it is heated during a certain time according to the requirements of the experiment. Finally, after the heating process, the robot takes the piece and carries it through certain movements to the storage table.

In figure 4.2 a flowchart of the process can be appreciated.

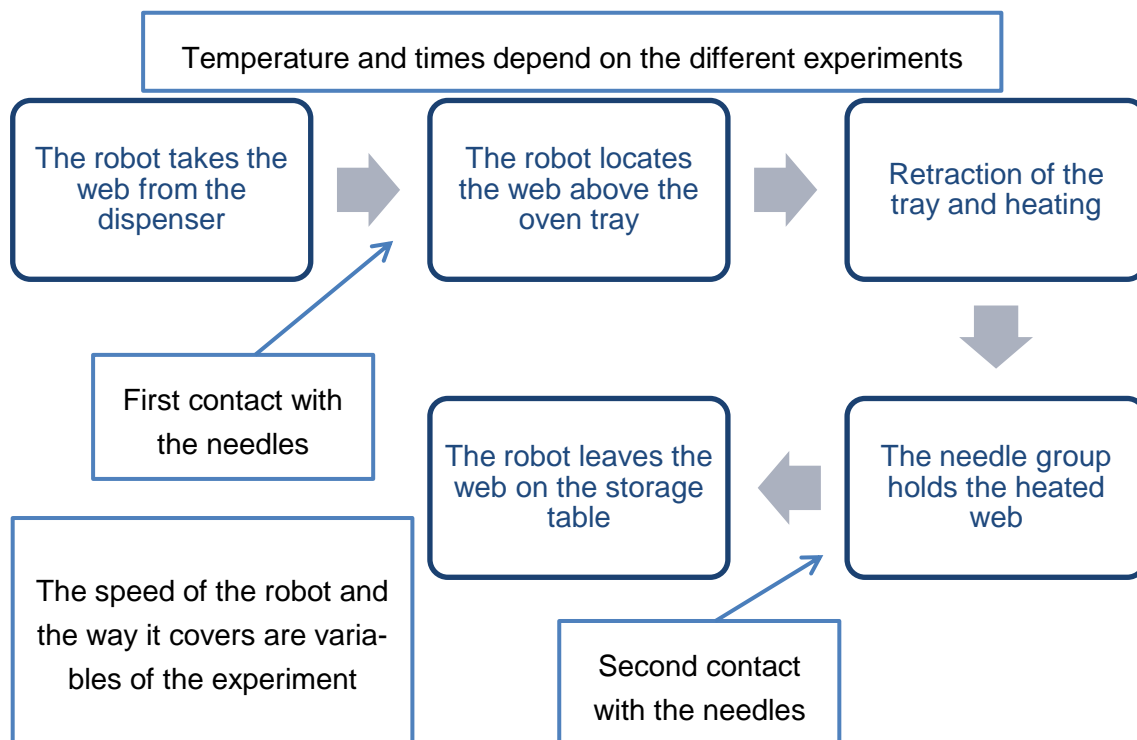

Fig. 4.2: Flowchart of the segment of the process employed in the first tests.

#### 4.3.1 Parameters of the first experiments

Number of layers of the web: several experiments were carried out varying the number of layers that formed the web. Tests were made from 1 to 4 layers. No more than 4 subjects were used because it has no practical interest in the process, as the mould does not support thicknesses of more than 4 layers of this material.

Different web creation processes: the duration of the heating with the manual press and the cooling under pressure processes were also modified in order to obtain specimens of different grade of compaction.

Temperature of the web surface when leaves the oven: this, in particular, is one of the most significant parameters of the process and is one of those that more attention has been placed in. Temperatures ranging from ambient temperature to 300 °C were tested.

The insertion of polyamide or not: in some cases a thin layer of additional polyamide was applied to the surface of the piece in the web obtaining process.

The speed of the robot: the robot's operating speed was also considered as a variable, which oscillated between 10% and 100% of the maximum possible.

The movements of the robot: two different programs for the robot were used. The first composed of soft movements with the aim of the minor number of external forces acting on the web. And the second, with critical movements in the different axes in which the web is submitted to diverse forces, the centrifugal ones caused by the rotation on

---

the central axis (forces in y-axis), gravitational forces (z-axis) and air resistance forces (x-axis).

### **4.3.2 Conclusions and images of the first experiments**

The results were evaluated in terms of the trace's magnitude that needle group left on the surface of the web.

In general webs formed by 4 layers and with a method of creation as the one specified in paragraph 4.2 had the best results.

As far as the furnace temperature is concerned, the best results were at ambient temperature 21.2°C, without using the oven. In general, the lower the surface temperature of the workpiece the mark of the needles is lower. However, the process is limited by the melting temperature of the polyamide, which is 260 ° C and the web must reach at least this.

After several experiments it can be concluded that the addition of polyamide repeatedly improves the final surface.

As far as the speed of the robot is concerned, there are no significant differences in the different webs. However, the marks left by the needles are clearer in the case of high speeds.

The same happens with the types of movement. In experiments with abrupt movements the holes left by the needles are cleaner and can be better distinguished.

### **4.3.3 Images of the first experiments**

Below are some images of the traces left by the needle group in the webs. All the webs of the figures are 4 layers based and the creation method is the one specified in paragraph 4.2.

The selected preforms are webs in which most of the parameters are around the values used in the process. Temperatures range from 250 °C to 300 °C and in most of the cases the robot speed is the maximum.

The other parameters associated with the images which vary according to the type of test carried out, are specified in the table below.



Tab. 4.1: Parameters values of the figures attached.

Figure	T <sup>a</sup> surface (°C)	Polyamide	Speed (%)	Movements
4.3	250	No	100	Critic
4.4	300	No	10	Soft
4.5	275	Yes	50	Soft
4.6	225	Yes	100	Critic
4.7	275	Yes	100	Critic

Pictures of the first experiments are shown below. Each one of the divisions of the scale at the bottom of the images is equivalent to 1mm.

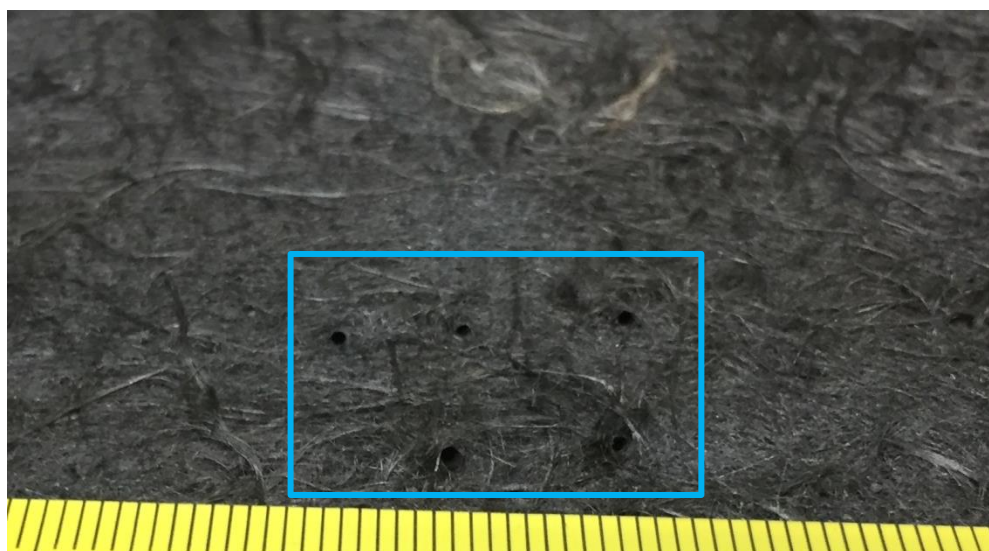
Fig. 4.3: T<sup>a</sup> of 250 °C without polyamide with critic movements at 100% speed.

As was mentioned earlier, in processes with critical movements and high speeds the holes left by the needle group are clearer. This can be contrasted with the holes in the web shown in Figure 4.4 in which the robot's movements were soft and the speed was the minimum possible.



Fig. 4.4:  $T^a$  of 300 °C without polyamide with soft movements at 10% speed.



Fig. 4.5:  $T^a$  of 275 °C with polyamide with critic movements at 50% speed.

This is the first image with a web that has been applied polyamide. Can be seen that the surface is smoother than the previous ones where carbon fibre threads can still be identified.

This difference can be best appreciated in the following figures of webs with polyamide.

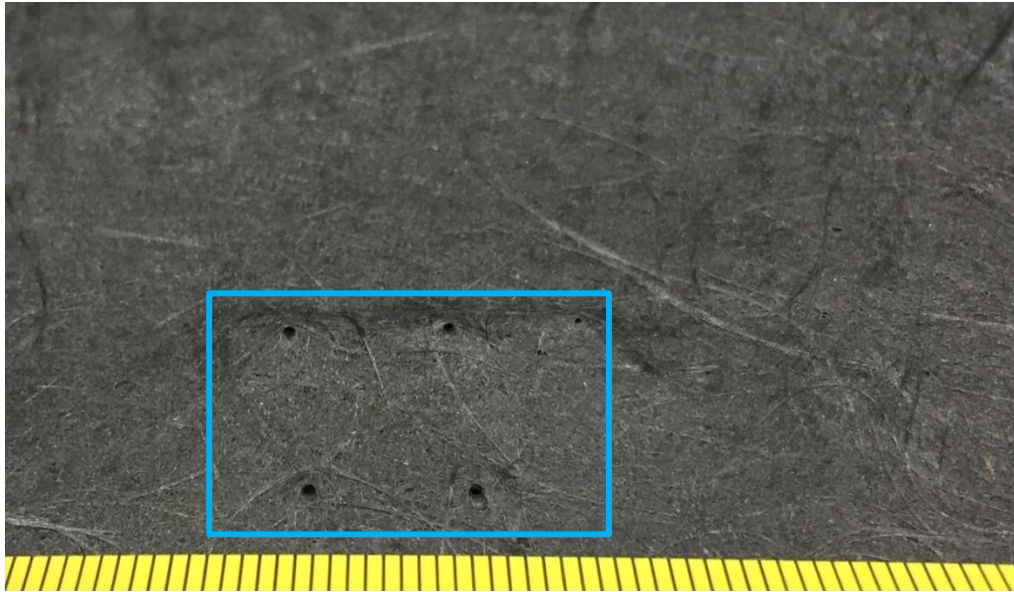

Fig. 4.6:  $T^a$  of 225 °C with polyamide with critic movements at 100% speed.

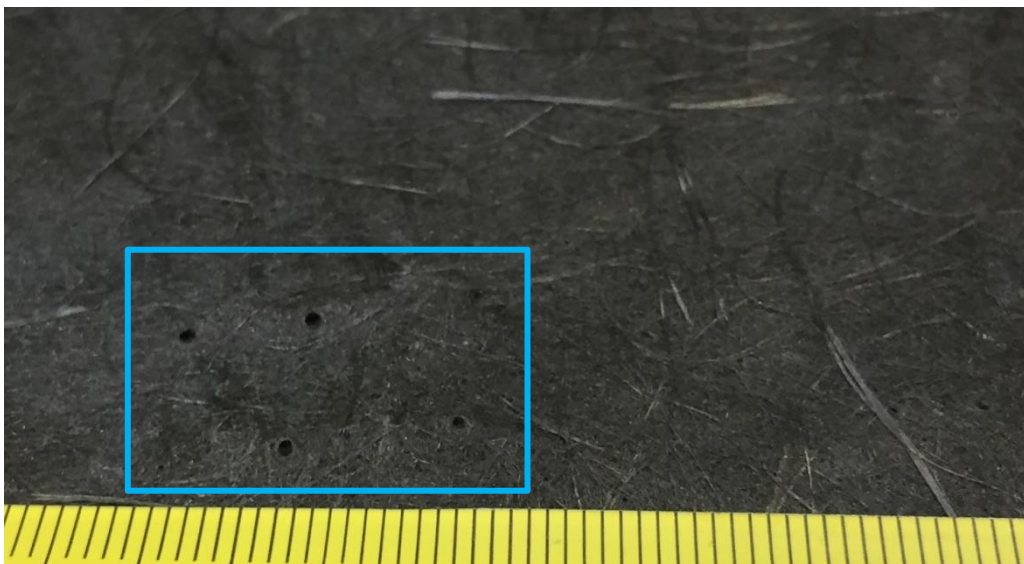

Fig. 4.7:  $T^a$  of 275 °C with polyamide with critic movements at 100% speed.

#### 4.4 Experimental design

One of the most important parts of the thesis is the development of an experimental design applied to the entire automated process with the aim to determine which of the factors affect the response more. The response will be the roughness of the web surface and will be measured with the help of a roughness meter “Mitutoyo SJ-400”.

For this section an experimental design of 3 factors has been prepared, these 3 factors are the composition of the web, the temperature of the surface when the web leaves the furnace and the temperature of the mould. The temperature of the mould will be the

temperature of the oil that circulates by its interior plus the heat produced by the induction plates acting on it.

The temperatures of the web surface and the mould will have 3 levels, that is to say, there will be a low temperature, an average and a high one despite the fact that the temperature of the mould will be determined by the time the induction plates act. However, for the composition of the web there will be only two levels, that is, two types of composition that is polyamide and polyester with 40% CF each of them.

As it is an experiment of 3 factors, two of them with 3 levels and one with 2, 18 trials must be performed so that the experiment significant is.

Table 4.2 collects the different combination of the diverse factors in all experiments.

Tab. 4.2: Dependent variable combinations in the experiment.

Test	Composition	T <sup>a</sup> oven (°C) and time (s)	Time induction (s)
1	40% CF 60% PA	260 °C and 80 s	20 s
2	40% CF 60% PA	260 °C and 80 s	40 s
3	40% CF 60% PA	260 °C and 80 s	60 s
4	40% CF 60% PA	280 °C and 80 s	20 s
5	40% CF 60% PA	280 °C and 80 s	40 s
6	40% CF 60% PA	280 °C and 80 s	60 s
7	40% CF 60% PA	300 °C and 80 s	20 s
8	40% CF 60% PA	300 °C and 80 s	40 s
9	40% CF 60% PA	300 °C and 80 s	60 s
10	40% CF 60% PET	260 °C and 80 s	20 s
11	40% CF 60% PET	260 °C and 80 s	40 s
12	40% CF 60% PET	260 °C and 80 s	60 s
13	40% CF 60% PET	280 °C and 80 s	20 s
14	40% CF 60% PET	280 °C and 80 s	40 s
15	40% CF 60% PET	280 °C and 80 s	60 s
16	40% CF 60% PET	300 °C and 80 s	20 s
17	40% CF 60% PET	300 °C and 80 s	40 s
18	40% CF 60% PET	300 °C and 80 s	60 s

The density of the materials was  $680 \text{ g/m}^2$  for non-woven webs composed of 40% CF 60% PA and  $212 \text{ g/m}^2$  for webs composed of 40% CF 60% PET.

As the density of the raw materials is very different since the polyester nonwoven is 3 times less than the polyamide one, the webs employed will not have the same number of layers because its width would be very different. Therefore, 12 layers will be used to achieve similarity between the different webs.

An explanatory flowchart of the process with temperatures, times and weight for polyester webs is shown in the Figure 4.8.

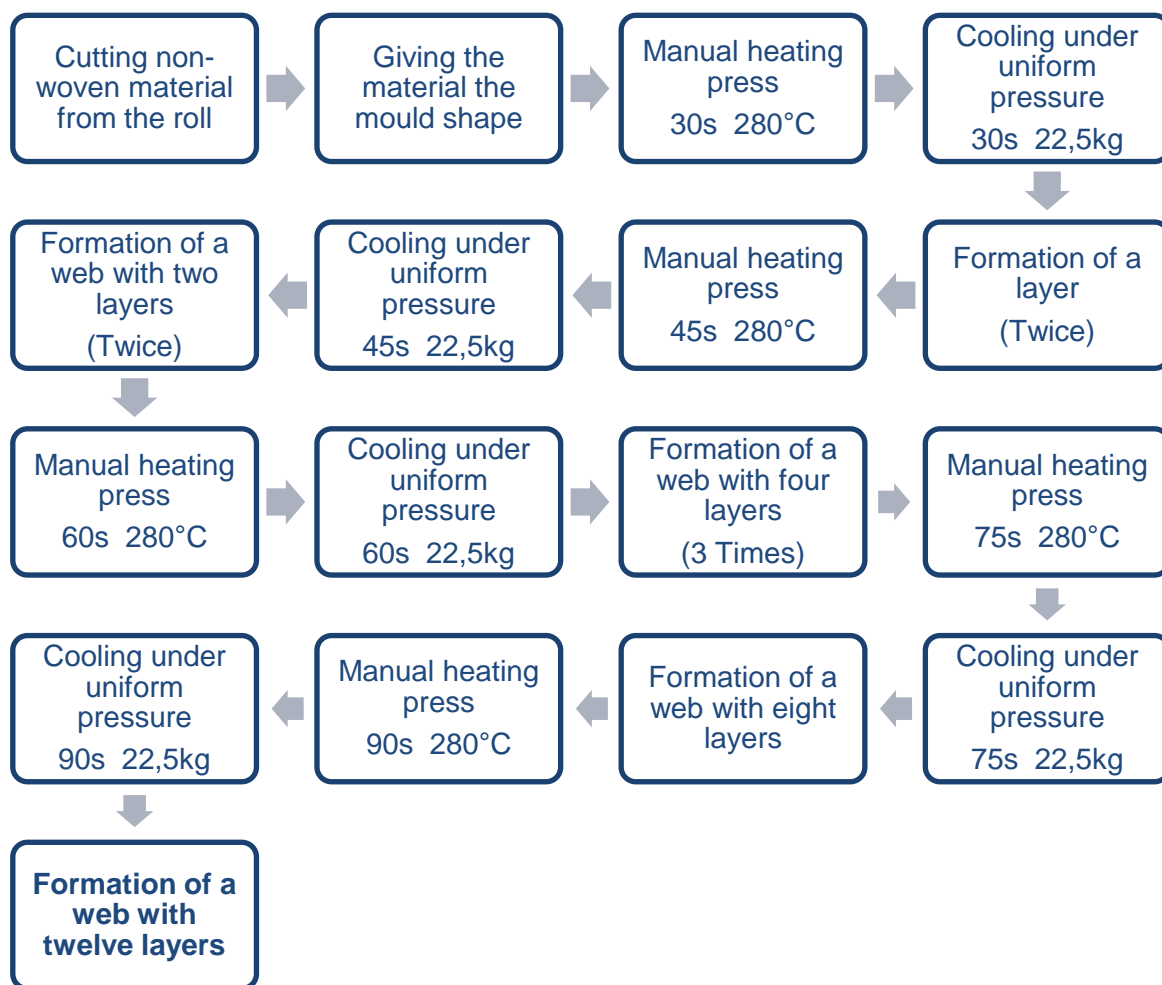

Fig. 4.8: Flowchart of the polyester webs preparation process.

## 4.5 Parameters of the process

As it is an automated process with peripheral units such as oven, press and injection unit there are a large number of parameters in the process.

### 4.5.1 Temperature

Temperature is one of the most important parameters of the process as it is present in the oven and the moulds. In experiments the temperature varies both in the oven and in the mould. This parameter is also present in the refrigeration flow of induction plates which has a value between 20 °C and 21 °C.

### 4.5.2 Pressure

This is another parameter with great importance as it is present in the press, the robot, the furnace and the refrigeration flow of the induction plates.

The overall set of the machine has compressed air ducts that allow the opening and closing of the oven as well as the movements of robot and needle group respectively.

The unit providing the cooling flow of the induction plates operates at a pressure between 3 and 4 bar.

Finally, this parameter is represented in the force exerted by the press on the surface of the web. This force is 2000kN on an approximate surface of 35 cm<sup>2</sup> which results in  $5,7 \cdot 10^8$  Pa.

### 4.5.3 Time

This parameter is present in the cycle time of the robot, the heating time in the oven, the time that the induction plates act and the compression time of the press.

The heating time in the oven remains constant in all the process and is 80 seconds whereas the time the induction plates act varies between 20 and 60 seconds.

The duration of the press process is 30 seconds approximately. Of those 30 seconds 25 correspond to the compression process while the rest are distributed in the closing and opening of the moulds and the movement of the cores.

Since the Start button is pressed until the robot returns home the duration of a full cycle is 1 minute 50 seconds.

An explanatory flowchart of the process cycle is shown in the Figure 4.1

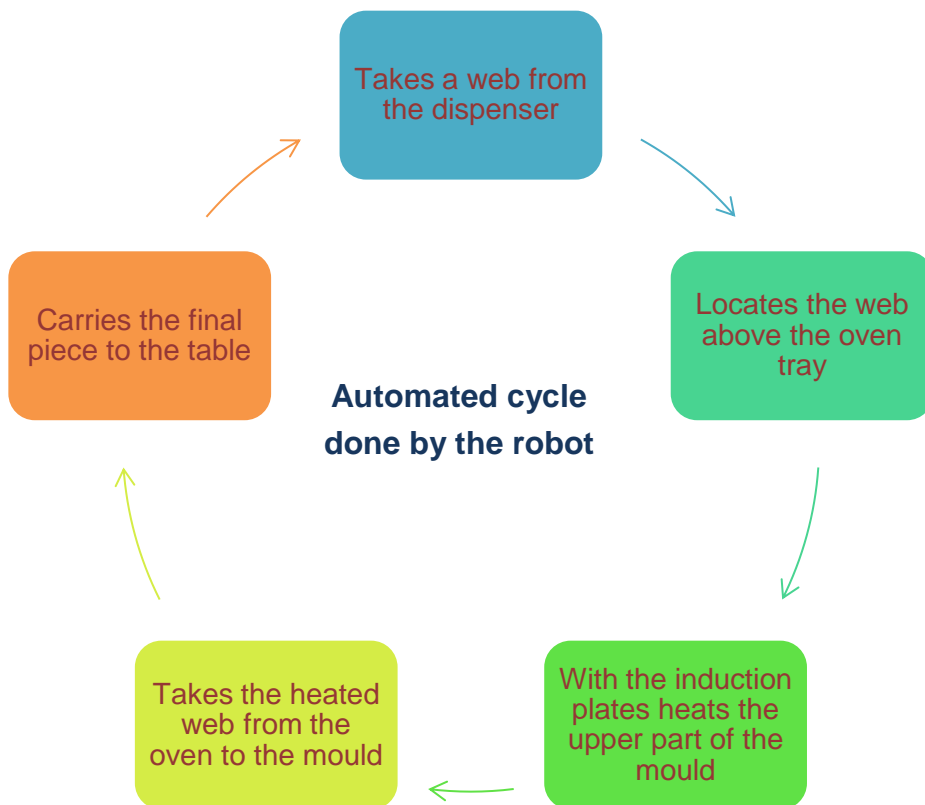

Fig. 4.9: Flowchart of the automated process cycle done by the robot.

#### 4.5.4 Press parameters

In addition to temperature, time and pressure there are also parameters of the different peripheral units. This is the case of the press in which other variables are also involved as the closing speed of the mould, which at the beginning is 385 mm/s and decreases when the upper and lower part of the mould are close.

The speed and the force related to distance are represented in Figure 4.9.

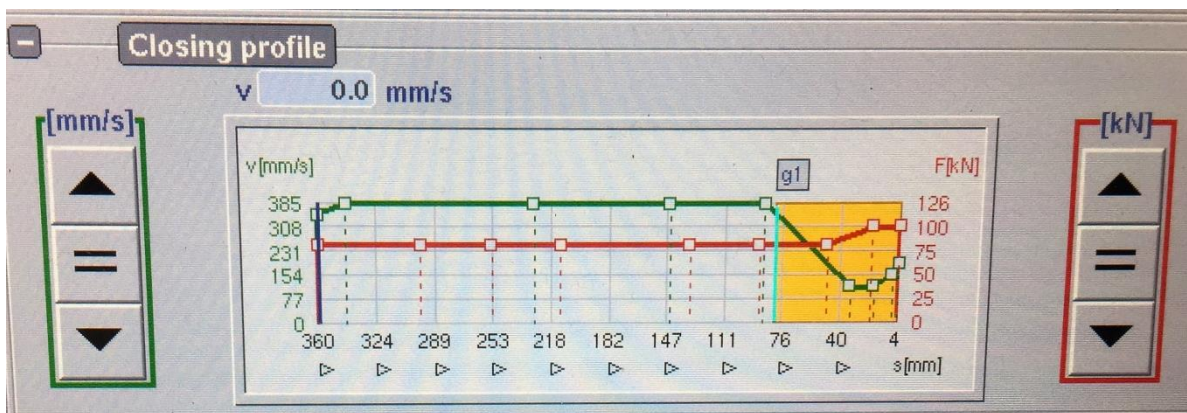

Fig. 4.10: Representation of speed (mm/s) and force (kN) versus distance (mm).

However, the force remains constant during the closing period and grows as both moulds approach until they come in contact reaching a value of 2000 KN.

The last relevant parameter of the press is the mould closing position which has a value between a third and a half of the web thick. If the mould closing value does not reach this number the mould will not close well and the experiments will not be valid.

#### **4.5.5 Induction unit**

The induction unit has a set of parameters characteristic of its internal method. These are detailed below with their respective operational values:

- Root mean square intensity (Irms) 53-55 A
- Root mean square voltage (Urms) 450-460 V
- Intensity 13,5-13,7 A
- Frequency 10,0 kHz
- PW 750‰



## 5 Evaluation and statistical study

In the table below, roughness values of different areas are collected. In each web three different measures have been done. The first measure corresponds to the average surface roughness and was taken from a random point in the middle of the piece. The second and the third measures were taken over the area in which the needle group acted.

Several values of parameter Ra (Roughness average) were collected. Ra is the arithmetic average of the absolute values of the roughness profile ordinates, parameter which gives a good general description of the height variations in the surface.

Tab. 5.1: Roughness average values from different zones of the tested webs.

	Web	Average roughness ( $\mu\text{m}$ )	Roughness needle zone left ( $\mu\text{m}$ )	Roughness needle zone right ( $\mu\text{m}$ )	Roughness value ( $\mu\text{m}$ )
40% CF 60%PA	1	27,58	36,12	32,77	6,87
	2	26,76	28,40	30,00	2,44
	3	24,29	37,86	29,78	9,53
	4	13,52	35,75	27,75	18,23
	5	21,16	24,17	27,25	4,55
	6	15,25	25,21	27,26	10,99
	7	15,27	29,95	40,23	19,82
	8	15,32	40,62	28,33	19,16
	9	11,33	22,03	33,39	16,38
40% CF 60%PET	1	12,16	8,79	14,58	0,48
	2	11,92	9,86	13,68	0,15
	3	13,21	14,11	11,05	0,63
	4	10,26	8,85	8,77	1,45
	5	17,31	20,47	24,31	5,08
	6	11,67	8,29	12,13	1,46
	7	7,88	11,73	13,23	4,60
	8	6,01	14,81	21,47	12,13
	9	10,68	14,64	16,94	5,11

The roughness value is the response in the experimental design. It comes from doing the arithmetic mean of the roughness values of the needle zones and subtracting the average roughness.

Once all the variables of the experimental design are defined, we proceed to perform a variance analysis with "Statgraphics XVII".

In the Table 5.2 appears the ANOVA table for variable Roughness.

Tab. 5.2: ANOVA table for variable Roughness, type III Sums of Squares.

Source	Sum of Squares	Df	Mean Square	F-Ratio	P-Value
<b>A:T<sup>a</sup> oven</b>	276,976	2	138,488	21,05	<b>0,0075</b>
B:Time induction	6,52301	2	3,26151	0,50	0,6422
<b>C:Material</b>	328,363	1	328,363	49,91	<b>0,0021</b>
AB	60,295	4	15,0738	2,29	0,2209
AC	21,1795	2	10,5898	1,61	0,3070
BC	77,1613	2	38,5807	5,86	0,0647
RESIDUAL	26,3154	4	6,57886		
TOTAL	796,813	17			

All F-ratios are based on the residual mean square error.

The ANOVA table decomposes the variability of Roughness into contributions due to various factors.

The P-values test the statistical significance of each of the factors. Since 2 P-values (Material and T<sup>a</sup> oven) are less than 0,05 (significance level), these factors have a statistically significant effect on roughness at the 95,0% confidence level. This means that with a safety of 95,0% can be assured that variable roughness depends directly on the oven temperature and on the material employed.

Moreover, as this P-values are less than 0,01 the material and T<sup>a</sup> oven effect on roughness can be affirmed with 99,0% of confidence level.

However, the P-value of the induction time is 0,6422 greater than the significance level, so there is not enough evidence to reject the null hypothesis that the effect (induction time) does not affect to the response (roughness).

This means that the null hypothesis cannot be rejected, but not for that reason can be assumed that the null hypothesis is true, simply it cannot be determined.

In Figure 5.1 a graphical ANOVA for Roughness can be appreciated.

Also in attachments A 3, A 4 and A 5 graphic combinations of the factors are displayed.

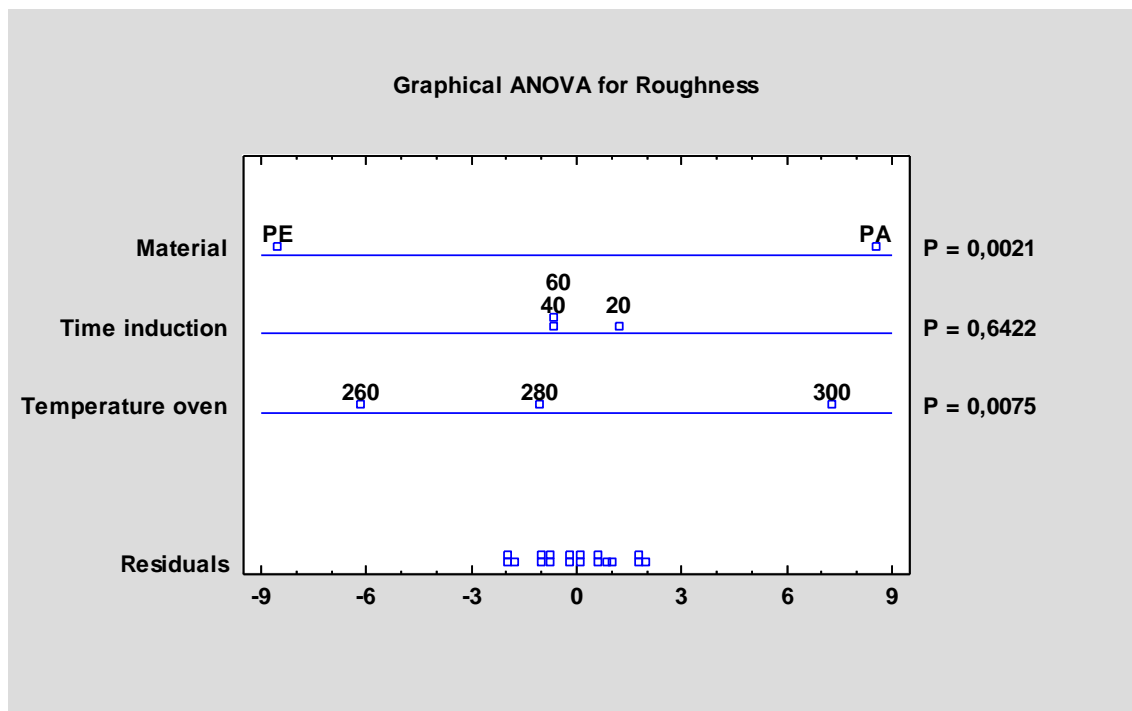

Fig. 5.1: Graphical ANOVA for Roughness.

## 6 Final experiments

The target of the previous paragraphs was to understand the influence of the different parameters on the surface of the pieces produced but the ultimate aim of this thesis is to get parts with good surface quality.

In order to get a smooth surface several experiments were carried out. These experiments took advantage of the results of the previous ones and aimed to get final pieces with good surface quality.

### 6.1 Reduction of the level of penetration of the needles

Needle grippers provide the option of reliable gripping of workpieces which are difficult to handle non-rigid and highly porous materials such as composite textiles, fleece, filter materials, etc. By intersecting needles an optimal holding force can be ensured.

An illustrative image of two needle groups holding a web is shown in Figure 6.1.

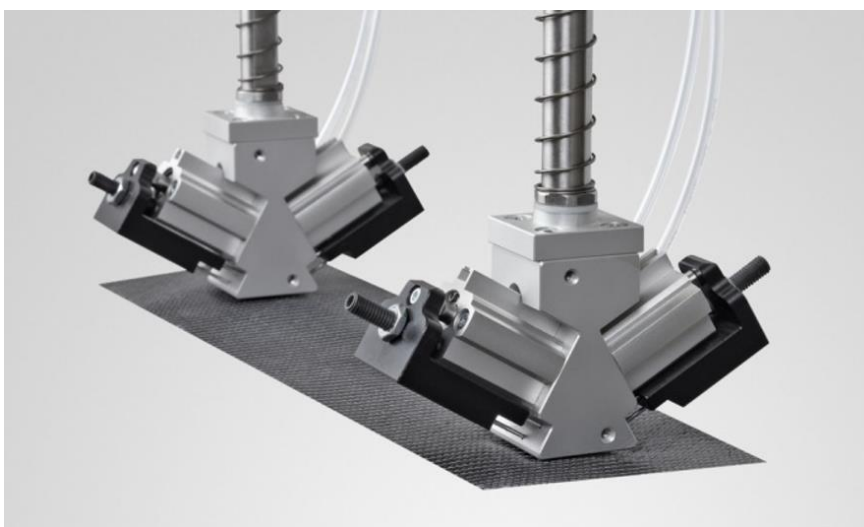

Fig. 6.1: Two needle grippers holding a composite web. [Die17]

In Table 6.1 appear the general characteristics of the needle group employed.

Tab. 6.1: General characteristics of the needle group. [Die17]

Number of needles	Length	Angle	Diameter	Material
10 (5 in each side)	15 mm	30	0.8 mm - 1.2 mm	Aluminum

In the experiments carried out so far the degree of opening of the needles was the maximum in order to guarantee a correct fastening so that no web releases of the needle group but this represents an inconvenient leaving considerable marks the surface.

---

Due to this, the degree of opening of the needle group was reduced to 5 mm, a minimum value that did ensure a correct holding and allowed to decrease the influence of the needle group.

## **6.2 Reduction of the cycle times**

This modification was made by my colleague Gonzalo, which consisted in reducing intermediate times in order to avoid the loss of the web temperature from the exit of the oven to its compression.

This was made by two steps, first movements with overgrinding were implemented which reduced the operation time of the robot and second, the speed of the upper mould was increased.

In attachment A 2 the representation of speed (mm/s) and force (kN) versus distance (mm) before and after the reduction of the cycle times is displayed.

## **6.3 Thermal impact reduction**

In order to reduce the thermal impact of the needles (whose temperature is the atmospheric) on the heated web, an alternative process in which the needles are heated, has been designed.

This idea appeared after the visualization of some images of the process made with a thermal camera. In the thermal images a difference of temperature between the zones in which the needle group act can be appreciated.

This issue is clearly shown in Figure 6.2 a thermal image of the web before being pressed by the mould. In this image a difference of colour, which means also difference of temperature, is clearly visible. The zones where the needle group acted are brighter than the rest of the web, which makes the thermal contrast problem obvious.

From this image can also be deduced that the distribution of temperatures on the web after leaving the oven is uniform except the areas mentioned.

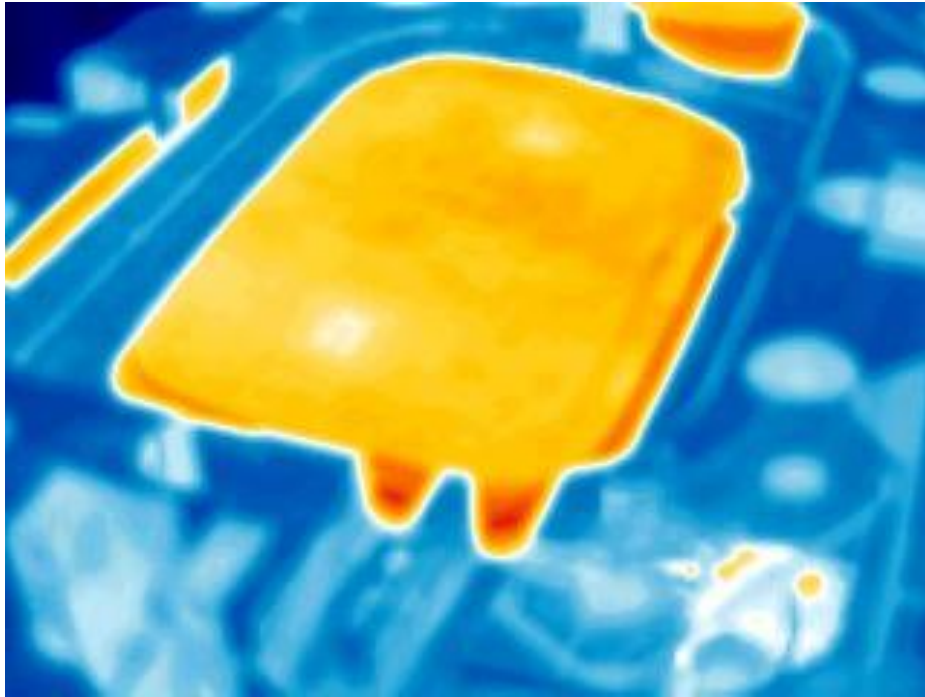

Fig. 6.2: Distribution of temperatures in a composite web before being compressed.  
Source: ITA.

The oven has two left and right modules. In the experiments held so far only the right part was used.

This alternative process, programmed by Gonzalo, basically consists in the adoption of the left oven to heat an expendable web for heating up the needles.

This is achieved by introducing three seconds before the disposable web in the left oven, so, five seconds before collecting the final web the robot inserts the needles into the expendable web with the aim to increase the temperature of the needles and reduce the thermal impact, which influences the surface quality of the piece as shown in paragraph 4.

In attachment A 1 is schematically represented the final programming code of the whole automated process.

An explanatory flowchart of the alternative process cycle is shown in the Figure 6.3.

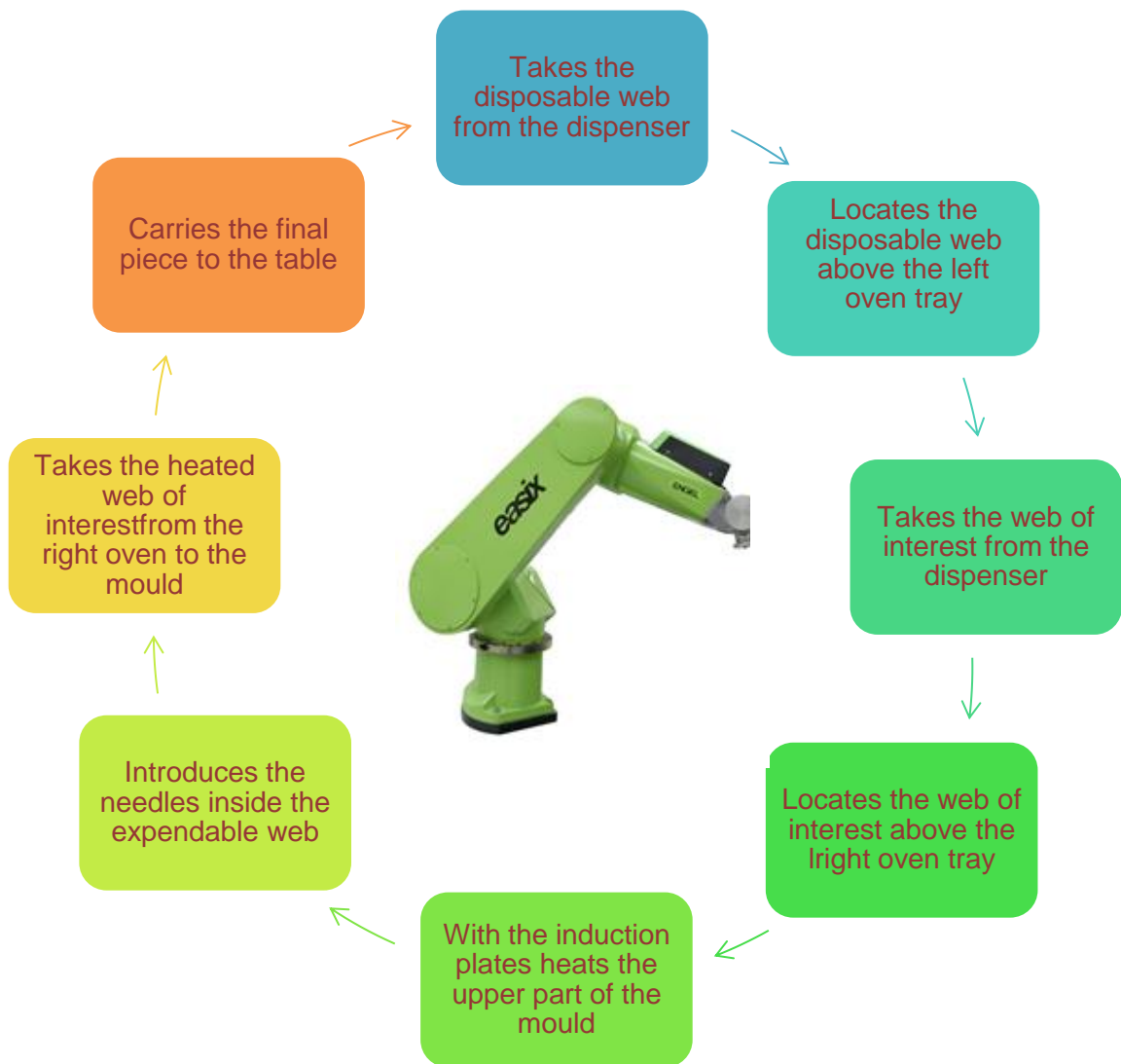

Fig. 6.3: Explanatory flowchart of the process cycle done by the robot.

## 6.4 Application of a layer of polyamide

In point 4.3 after several experiments, was concluded that the addition of polyamide repeatedly improves the final surface.

Therefore, the web used in this section will have a thin layer of polyamide applied on its surface. This will provide an additional brightness, which improves the appearance of the final piece. In addition in the last experiments an additional second layer of polyamide was applied in order to know whether a layer was or not enough.

## 6.5 Results and images

In the table below the specifications of the last experiments accompanied are collected. In these experiments the same materials as before were used so in the column of material PET is referred to 40% CF 60% PET and PA to 40% CF 60% PA.

The  $T^a$  of the lower mould remained constant with a value of 120°C, because the main interest of thesis resides in the upper surface and this parameter did not change to avoid its influence in the results.

Tab. 6.2: Specifications of the last experiments made.

Web	Material	$T^a$ oven and duration	Time induction plates	Polyamide (layers)	Left oven	$T^a$ upper mould	Ra needle zone ( $\mu\text{m}$ )
<b>1</b>	<b>PET</b>	<b>300°C 80 s</b>	<b>60 s</b>	<b>One</b>	<b>No</b>	<b>140°C</b>	<b>4,56</b>
<b>2</b>	<b>PET</b>	<b>280°C 80 s</b>	<b>45 s</b>	<b>One</b>	<b>Yes</b>	<b>135°C</b>	<b>5,13</b>
3	PET	250°C 80 s	45 s	Two	No	135°C	4,55
<b>4</b>	<b>PET</b>	<b>270°C 80 s</b>	<b>35 s</b>	<b>Two</b>	<b>Yes</b>	<b>135°C</b>	<b>4,01</b>
<b>5</b>	<b>PA</b>	<b>250°C 80 s</b>	<b>40 s</b>	<b>Two</b>	<b>Yes</b>	<b>125°C</b>	<b>2,97</b>
<b>6</b>	<b>PA</b>	<b>220°C 80 s</b>	<b>20 s</b>	<b>One</b>	<b>Yes</b>	<b>135°C</b>	<b>8,61</b>
7	PA	230°C 80 s	30 s	One	Yes	135°C	3,68
8	PA	230°C 80 s	25 s	One	Yes	140°C	11,71
<b>9</b>	<b>PA</b>	<b>230°C 80 s</b>	<b>0 s</b>	<b>One</b>	<b>Yes</b>	<b>160°C</b>	<b>3,24</b>
<b>10</b>	<b>PA</b>	<b>230°C 80 s</b>	<b>60 s</b>	<b>Two</b>	<b>Yes</b>	<b>125°C</b>	<b>8,16</b>
<b>11</b>	<b>PA</b>	<b>240°C 80 s</b>	<b>40 s</b>	<b>One</b>	<b>No</b>	<b>130°C</b>	<b>12,08</b>
12	PA	260°C 80 s	40 s	One	No	130°C	<b>9,19</b>

Below pictures of certain final parts will be displayed. In particular will be the boldly remarked pieces in the upper table, which have been chosen for their relevance.

Each figure will be accompanied by a table in which the main characteristics of both process and quality are collected.

A series of conclusions derived from these results will subsequently be established.



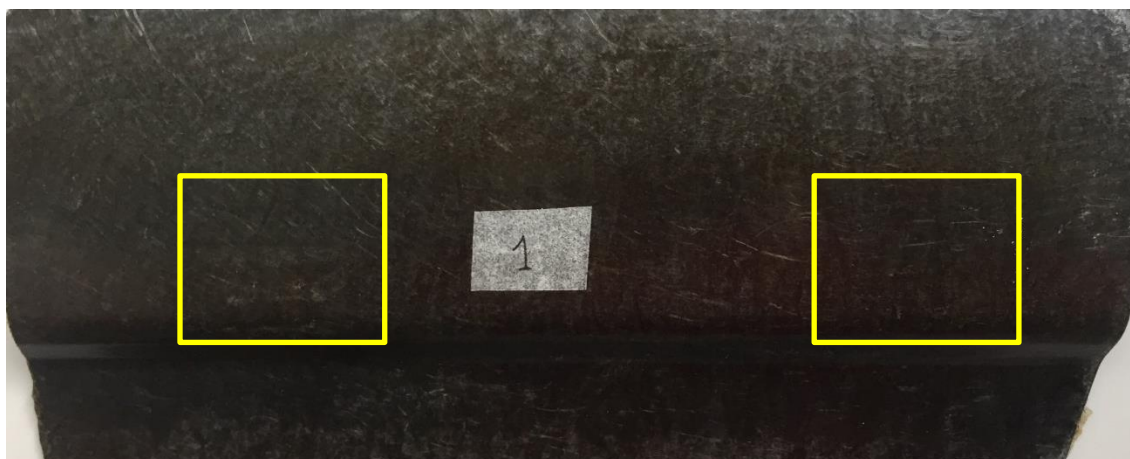

Fig. 6.4: Final piece corresponding to web number 1.

Tab. 6.3: Main features of web number 1.

Web	Material	T <sup>a</sup> oven and duration	Time induction plates	Polyamide (layers)	Left oven	T <sup>a</sup> upper mould	Ra needle zone (μm)
<b>1</b>	<b>PET</b>	<b>300°C 80 s</b>	<b>60 s</b>	<b>One</b>	<b>No</b>	<b>140°C</b>	<b>4,56</b>

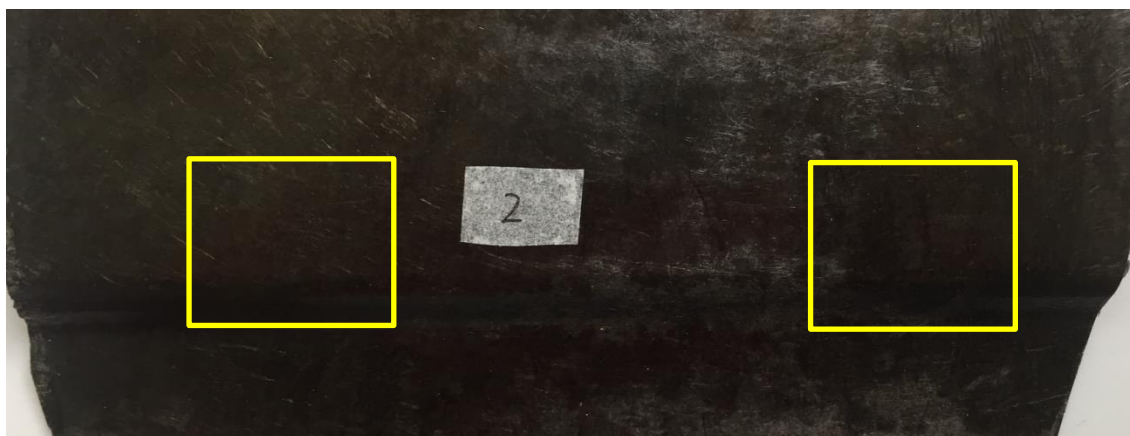

Fig. 6.5: Final piece corresponding to web number 2.

Tab. 6.4: Main features of web number 2.

Web	Material	T <sup>a</sup> oven and duration	Time induction plates	Polyamide (layers)	Left oven	T <sup>a</sup> upper mould	Ra needle zone (μm)
<b>2</b>	<b>PET</b>	<b>280°C 80 s</b>	<b>45 s</b>	<b>One</b>	<b>Yes</b>	<b>135°C</b>	<b>5,13</b>

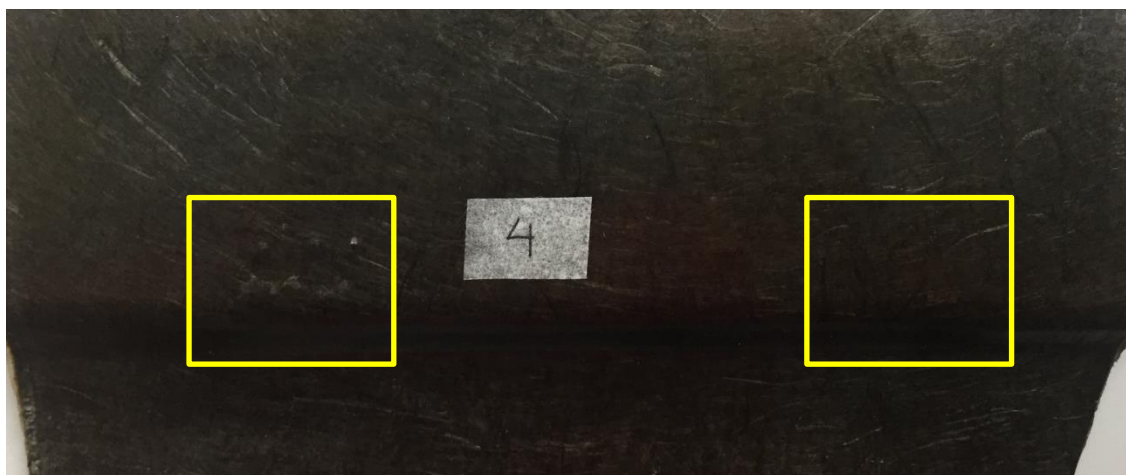

Fig. 6.6: Final piece corresponding to web number 4.

Tab. 6.5: Main features of web number 4.

Web	Material	T <sup>a</sup> oven and duration	Time induction plates	Polyamide (layers)	Left oven	T <sup>a</sup> upper mould	Ra needle zone (μm)
<b>4</b>	<b>PET</b>	<b>270°C 80 s</b>	<b>35 s</b>	<b>Two</b>	<b>Yes</b>	<b>135°C</b>	<b>4,01</b>

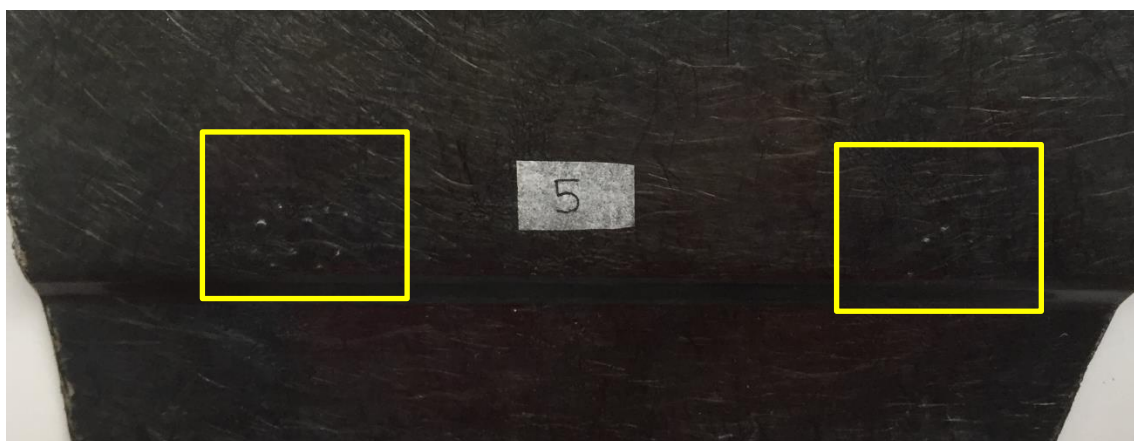

Fig. 6.7: Final piece corresponding to web number 5.

Tab. 6.6: Main features of web number 5.

Web	Material	T <sup>a</sup> oven and duration	Time induction plates	Polyamide (layers)	Left oven	T <sup>a</sup> upper mould	Ra needle zone (μm)
<b>5</b>	<b>PA</b>	<b>250°C 80 s</b>	<b>40 s</b>	<b>Two</b>	<b>Yes</b>	<b>125°C</b>	<b>2,97</b>



Fig. 6.8: Final piece corresponding to web number 6.

Tab. 6.7: Main features of web number 6.

Web	Material	T <sup>a</sup> oven and duration	Time induction plates	Polyamide (layers)	Left oven	T <sup>a</sup> upper mould	Ra needle zone (μm)
<b>6</b>	<b>PA</b>	<b>220°C 80 s</b>	<b>20 s</b>	<b>One</b>	<b>Yes</b>	<b>135°C</b>	<b>8,61</b>

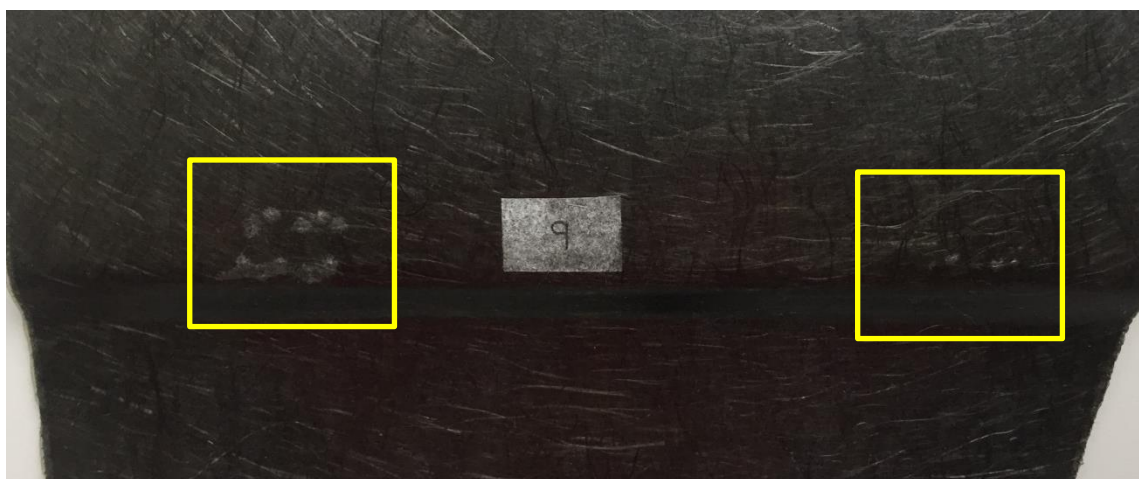

Fig. 6.9: Final piece corresponding to web number 9.

Tab. 6.8: Main features of web number 9.

Web	Material	T <sup>a</sup> oven and duration	Time induction plates	Polyamide (layers)	Left oven	T <sup>a</sup> upper mould	Ra needle zone (μm)
<b>9</b>	<b>PA</b>	<b>230°C 80 s</b>	<b>0 s</b>	<b>One</b>	<b>Yes</b>	<b>160°C</b>	<b>3,24</b>

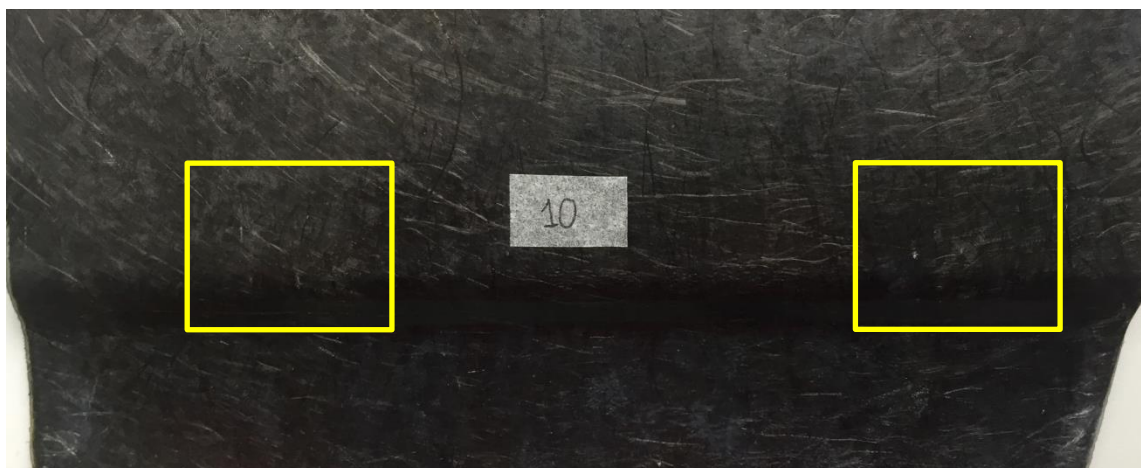

Fig. 6.10: Final piece corresponding to web number 10.

Tab. 6.9: Main features of web number 10.

Web	Material	T <sup>a</sup> oven and duration	Time induction plates	Polyamide (layers)	Left oven	T <sup>a</sup> upper mould	Ra needle zone (μm)
<b>10</b>	<b>PA</b>	<b>230°C 80 s</b>	<b>60 s</b>	<b>Two</b>	<b>Yes</b>	<b>125°C</b>	<b>8,16</b>

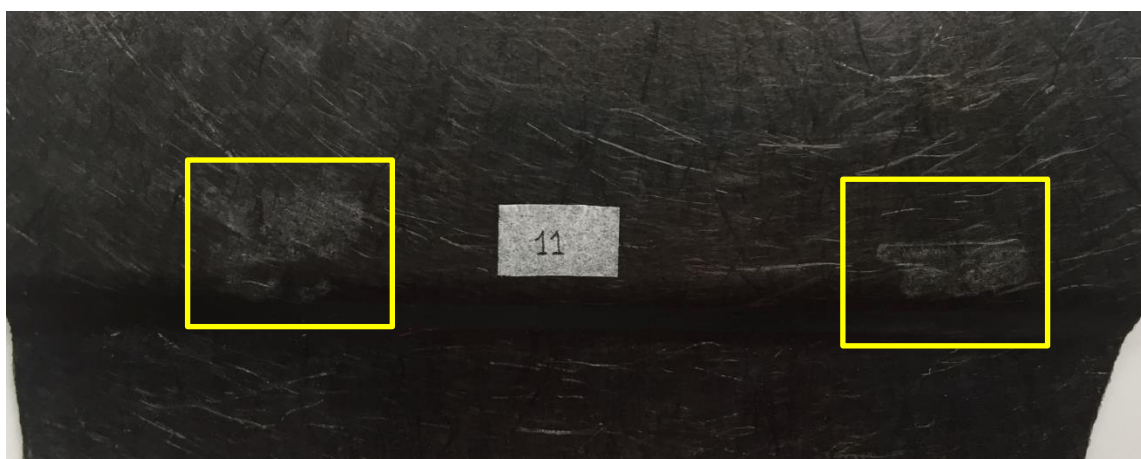

Fig. 6.11: Final piece corresponding to web number 11.

Tab. 6.10: Main features of web number 11.

Web	Material	T <sup>a</sup> oven and duration	Time induction plates	Polyamide (layers)	Left oven	T <sup>a</sup> upper mould	Ra needle zone (μm)
<b>11</b>	<b>PA</b>	<b>240°C 80 s</b>	<b>40 s</b>	<b>One</b>	<b>No</b>	<b>130°C</b>	<b>12,08</b>

Following, different marks of the pieces are compared with each other in order to establish explanations of this phenomenon.

Three comparisons between two different pieces are going to be made. The webs compared have been chosen deliberately for being the most explanatory.

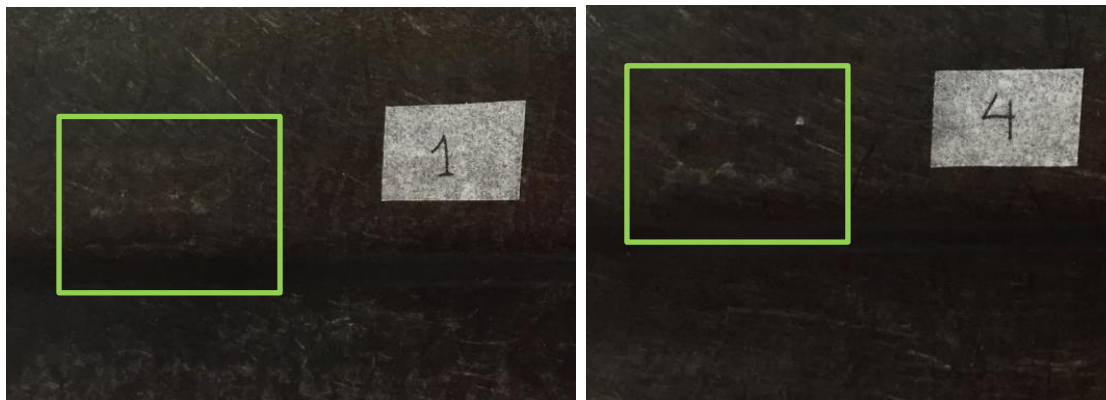

Fig. 6.12: Comparison between webs 1 and 4 needle marks.

In general, web number 4 has obtained better results than the number 1. The marks are different between them, in the first one there is a greater mark area than in the fourth. Despite this, considering only the  $R_a$  in the needle zone both webs carried out similar results being this value  $4,56 \mu\text{m}$  and  $4,01 \mu\text{m}$  respectively.

As far as process parameters are concerned, piece number 1 was more aggressively heated being the  $T^a$  of the oven  $300^\circ\text{C}$  and the time the induction plates act 60s, in contrast with the  $270^\circ\text{C}$  and 35s of piece number 4.

It needs to be mentioned that in web number 1 the left oven was not used and it only had applied one layer of polyamide while web number 4 had the left oven and two layers of polyamide.

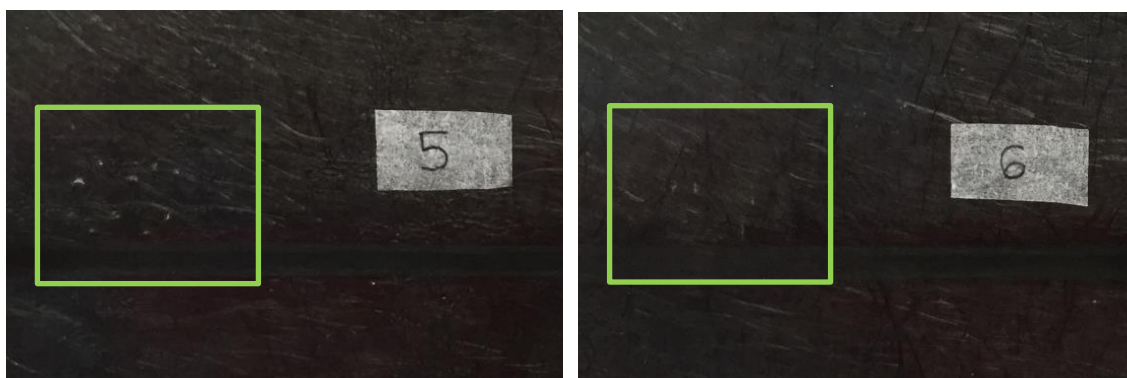

Fig. 6.13: Comparison between webs 5 and 6 needle marks.

In web number 5 the mark of the needles is clearer than in the 6, but this is positive because the needles only affect the area of action leaving the interspace untouched.

For this reason the roughness value of this area is the smallest of all parts with a value of  $2,97 \mu\text{m}$  in contrast with the  $8,61 \mu\text{m}$  of part number 6.

Both webs were tested with the use of the second oven but the temperature parameters differ from each other. First, in number 5 the temperature of the oven and the time of induction were higher 250°C and 40s against the 220°C and 20s of number 6, which leads to deduce that low temperatures do not help to improve the surface.

The last comparison is focused on comparing the difference in surface quality obtained after the addition of the left oven and the double polyamide. For that reason a comparison within webs 10 and 11 has been done.

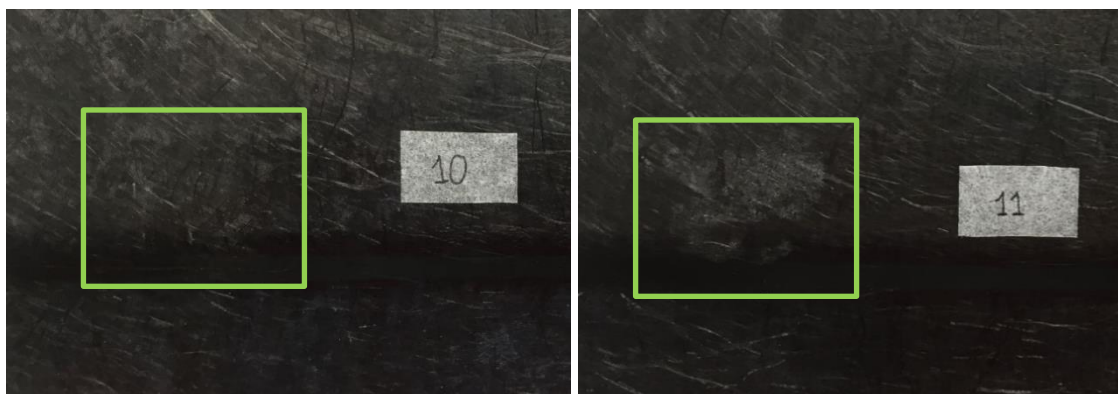

Fig. 6.14: Comparison between webs 10 and 11 needle marks.

The two webs have a very similar process but the difference of quality is clear both visual and in term of roughness. Number 10 is heated to 230°C, the induction time is 60s and the temperature of the upper mould is 125°C and number 11 is heated to 240°C with 40s of induction and 130°C of the upper mould.

It is evident that the reduction of the thermal impact produced by the needle gripper with the implementation of the left oven and the addition of a second layer of polyamide, aid to reduce the marks and therefore improve the final piece quality.

---

## 7 Summary, conclusions and outlook

### 7.1 Summary

The objective of this thesis is the improvement of the surface quality of the pieces produced in an automatic process from web based thermoplastic composites. For this purpose, a thorough study of the factors of the process influencing the surface quality of the piece was carried out.

These parameters of influence encompass the material, oven and moulds temperatures, the time that the induction plates act, the addition of an additional thermoplastic such as polyamide, the action of the needle group responsible for holding the web in its movement across the process, the number of layers of the web, different web creation processes, the type of movements of the robot and the duration of the robot and press cycles.

As it were a large number of factors, several first trials were carried out on a segment of the process to determine the type of influence of certain parameters.

Later, with the results and conclusions derived from the previous trials, an experimental design applied to the entire automated process was performed. This experimental design had the aim to determine which of the factors affect the roughness value more.

Finally, on the basis of the results of the experimental design and the first trials small modifications in specific process parameters were made and subsequently, various final experiments were executed in order to get a smooth surface. These experiments took advantage of the results of the previous ones and aimed to get final pieces with good surface quality.

### 7.2 Conclusions

From all the experiments executed several conclusions were derived.

First, from the earliest trials the following judgements were arisen:

In general the higher the number of layers and with a method of creation as the one specified in paragraph 4.2 the better the results achieved.

Mainly, the lower the web surface temperature the lower the mark of the needles.

The addition of polyamide repeatedly improves the final surface.

As far as the speed of the robot is concerned, there are no significant differences in the different webs. However, the marks left by the needles are clearer in the case of high speeds.

---

The same happens with the types of movement. In experiments with abrupt movements the holes left by the needles are cleaner and can be better distinguished.

Second, from the experimental design relevant information was derived:

With a confidence level of 99% can be assured that the roughness value depends directly on the oven temperature and on the material employed.

However, the P-value of the parameter induction time was 0,6422 greater than the significance level 0,05, so there is not enough evidence to reject the null hypothesis that the effect (induction time) does not affect to the response (roughness).

Nonetheless can be assumed that the null hypothesis is true, simply it cannot be determined. This only means that in this design of experiments it has not been possible to determine the influence of the induction time on the surface quality. Probably in future experiments, the time that induction plates act should be increased to match the influence of the other two parameters.

Finally, from the latest experiments the following can be concluded:

In general, Polyester webs led to better results, in terms of roughness, than Polyamide ones.

The implementation of the left oven induced to better appearance results. This is clear in web number 11 in which the needle group marks are appreciable. The addition of the left oven aided to reduce this marks.

The addition of a second layer of polyamide improved the final surface but not in the way that the first layer enhances the normal web.

The decrease of the needles penetration together with shorter cycle times of robot and press also helped to reduce the needle group marks. That was for two reasons: first because the web entered the mould with a temperature closer to the melting point of the matrix and second, the needles remained less time and less deep in the web so their impact is diminished.

For polyester and polyamide the webs that achieved the best results are the number 4 and 5 respectively. The principal parameter values of these webs are collected in the table below.



Tab. 7.1: Parameter values of the webs with the best surface quality.

Material	T <sup>a</sup> oven and duration	Time induction plates	Polyamide (layers)	Left oven	T <sup>a</sup> upper mould
PE	270°C 80 s	35 s	Two	Yes	135°C
PA	250°C 80 s	40 s	Two	Yes	125°C

### 7.3 Outlook

The results obtained from the experiments are quite satisfactory because the surface quality has improved in comparison to the previous experiments and the aim of the thesis that was to achieve pieces with a good surface quality has been fulfilled.

There is a very large potential for optimization yet especially in the field of preparation the webs. Every web used in experiments takes a long time to produce in comparison with the time that the experiments take

If there had been a faster way to produce webs, the number of experiments would have been higher and the conclusions derived from them more accurate.

Also, more varieties of materials can be studied or another type of mould can be employed.

Anyway, the determining factor in the surface discontinuity of the parts is the needle group. A field of research could be the design of another type of method to hold the web that does not involve penetrating the surface.

## 8 Bibliography

- [Die17] Diez, G.:  
Development and implementation of a manufacturing process for web based thermoplastic composites, University of Augsburg, Institut für Textiltechnik Augsburg GmbH, Bachelor thesis, 2017.
- [Gar17] Garcia, M.:  
Preconsolidation of hybrid textiles for the production of web based thermoplastic composites, University of Augsburg, Institut für Textiltechnik Augsburg GmbH, Bachelor thesis, 2017.
- [M02] Mazumdar, S.:  
Composites Manufacturing: Materials, Product and Process Engineering  
CRC Press (2002),
- [CR14] Callister, William D.; Rethwisch, David G.:  
Materials Science and Engineering an introduction  
Wiley (2014),
- [H96] Hull, Derek.:  
Introduction to Composite Materials  
Cambridge University Press (1996),
- [PH10] Soo-Jin, P.; Gun-Young, H.:  
Carbon Fibres, Springer Series in Materials Science  
Springer (2010), S.200-230
- [A05] Besednjak, A.:  
Materiales compuestos. Procesos de fabricación de embarcaciones.  
Iniciativa Digital Politecnica (2005)
- [www09] <http://www.performance-composites.com/carbonfibre/>
- [A16] Stevenson, Anthony.:  
Recycling carbon fibres: state of the art and future developments  
International Textile Conference (2016)
- [SGG16] Job, S.; Leeke, G.; Oliveux, G.:  
Recycling Report 2016, composites recycling: where are we now?  
Composites UK (2016)

- 
- [Reg14] Regulation (EU) No 333/2014 of 11 March 2014 amending (EC) 443/2009 to define the modalities for reaching the 2020 target to reduce CO<sub>2</sub> emissions from new passenger cars.
- [LVD00] Life Vehicle Directive 2000/53/EC
- [McK12] McKinsey & Company  
Lightweight, heavy impact: How carbon fibre and other lightweight materials will develop across industries and specifically in automotive.  
<http://www.mckinsey.com/>  
February 2012
- [R99] Rotheiser, J.:  
Joining of Plastics, Handbook for Designers and Engineers  
Carl Hanser Verlag, Munich (1999).
- [H14] Hanser, C.:  
Composite materials, Carbon Fibre, Recovering Carbon Fibres  
Kunststoffe international (2014)
- [TR11] Trend Report, Engineering plastics  
Kunststoffe international 10/2011  
Carl Hanser Verlag, Munich
- [RLL11] Raghavalu, D. P.; Logstrup, T.; Lystrup, A.:  
Influence of moisture absorption on properties of fibre reinforced polyamide 6 composites.  
26th Annual Technical Conference of the American Society for Composites  
DEStech Publications (2011), Vol. 1, pp. 500-510
- [SJ07] Russell, S.J.:  
Handbook of nonwovens.  
The textile industry, CRC Press, Cambridge England, 2007
- [SGL17] SGL Group: Thermoplastic composite materials made from carbon and glass fibres  
<http://www.sglgroup.com/>  
Germany 03.2017
- [ED17] EDANA: Nonwovens formation  
<http://www.edana.org/>  
Brussels 2017

- 
- [Mar17]: Marin, P.:  
Erarbeiten von Anlagenparametern zur Erzeugung von Vliesstoffen unterschiedlicher Orientierung und deren Vergleich, Augsburg, Universität Augsburg, Institut für Textiltechnik Augsburg gGmbH, Bachelorarbeit, 2017
- [RAR12] McCool, R.; Murphy, A.; Wilson, R.:  
Thermoforming carbon fibre-reinforced thermoplastic composites  
Part L: Journal of Materials: Design and Applications, Vol 226, Issue 2, 2012
- [RT17] Resin Transfer Moulding (RTM) Process  
<http://www.moldedfibreglass.com/>  
Molded Fibre Glass Companies 2017
- [VI17] Vacuum Infusion Moulding (VARTM) Processing  
<http://www.moldedfibreglass.com/>  
Molded Fibre Glass Companies 2017
- [Kra17] Krauss Maffei: The perfect combination of thermoforming and injection molding  
<http://www.kraussmaffei.com/>  
Germany 2017
- [PT12] Article in Plastics Today: Hybrid thermoforming-injection process attracts auto industry interest.  
<https://www.plasticstoday.com/>  
02.12.11
- [Ege17] Eager, E.:  
Prozessentwicklung zur Fertigung von Prüfkörpern mittels Pressen von Kohlenstofffaser-Vliesen mit thermoplastischer Matrix, Augsburg, Universität Augsburg, Institut für Textiltechnik Augsburg GmbH, Bachelorarbeit, 2017.
- [EnM16] Engel Austria GmbH (Ed.):  
Operator Manual Machine IN 1050H/200  
Schwertberg: Engel Austria GmbH, 2016, [Firmenschrift]
- [Sch17] J. Schmalz GmbH  
<http://www.schmalz.com/en/applications/industries/composites/>

## 9 Attachments

### A 1 Sequence of robot programme

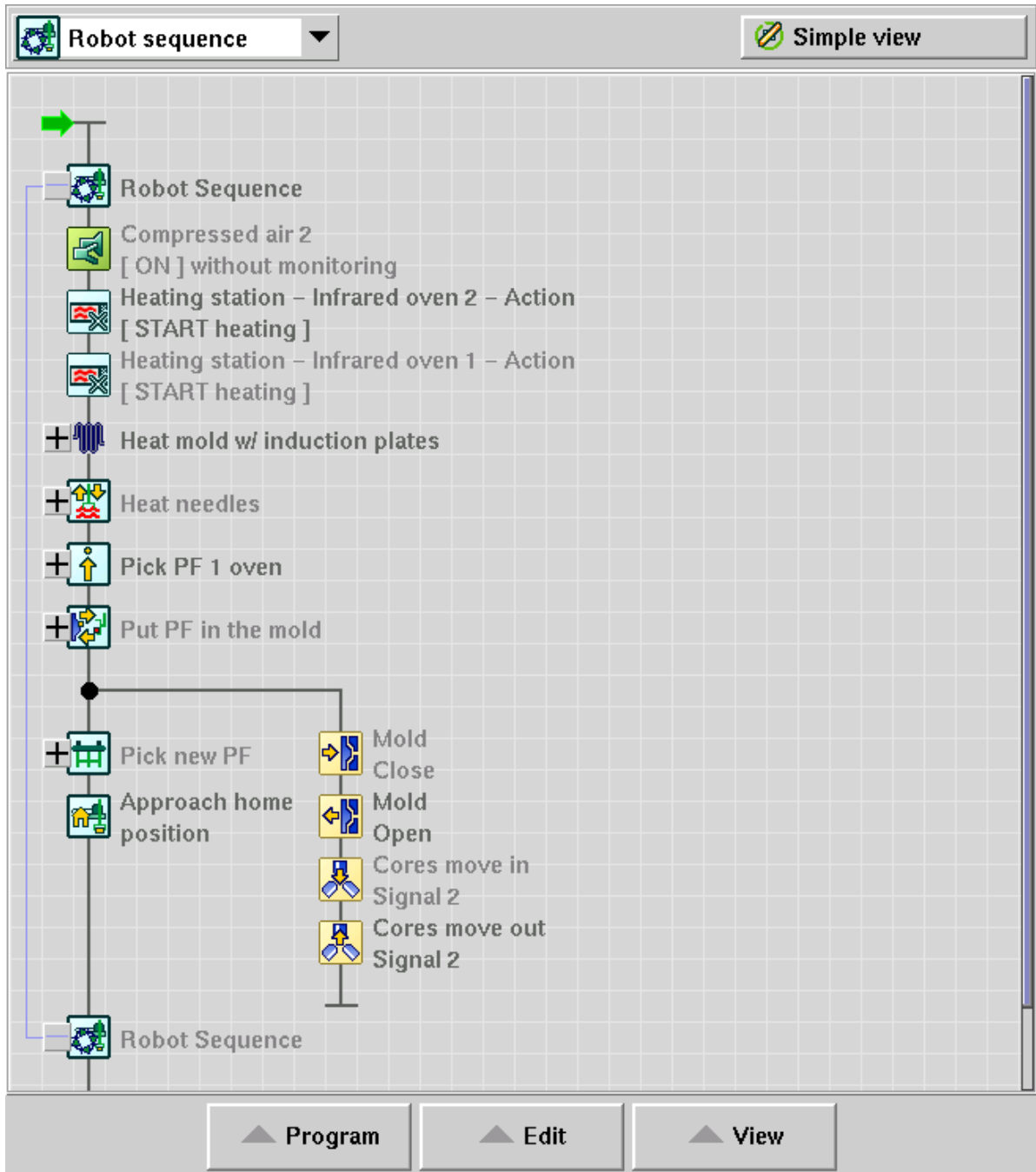

A 2 Representation of speed (mm/s) and force (kN) versus distance (mm) before and after the reduction of the cycle times.

Before:

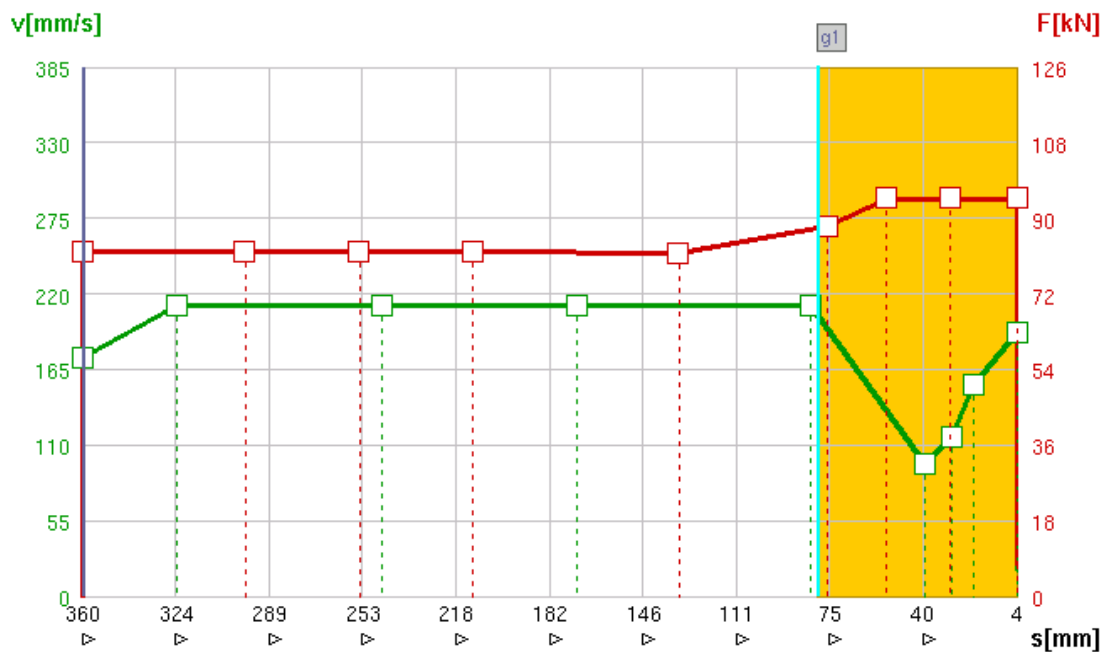

After:

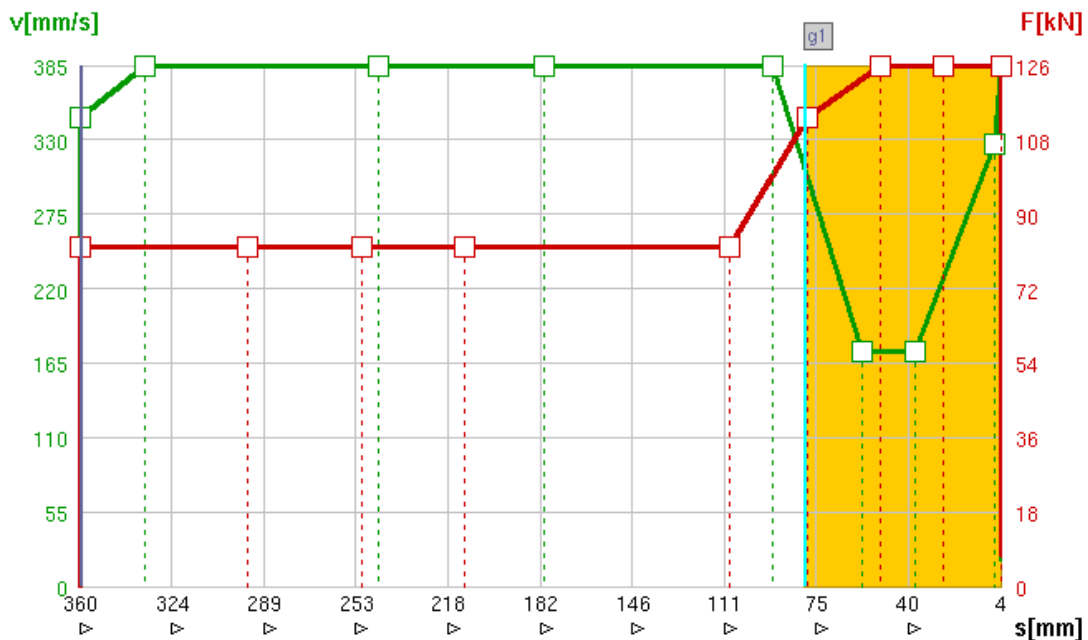

A 3 Interaction plot of material and time induction.

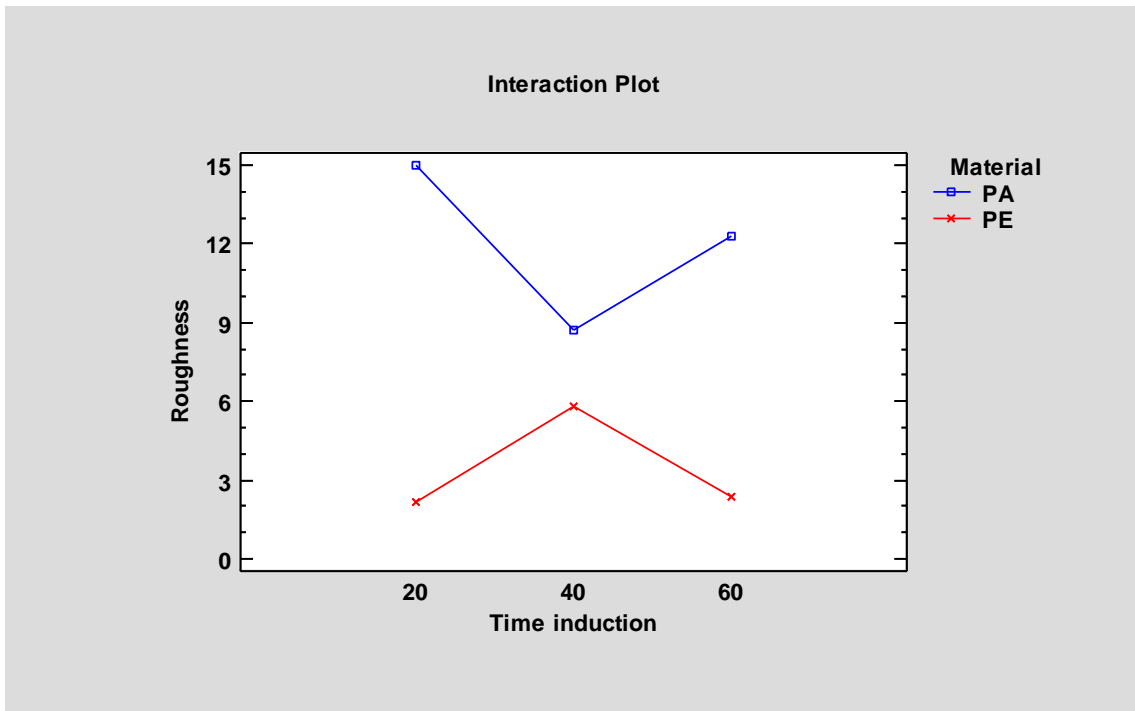

A 4 Interaction plot of material and temperature of the oven.

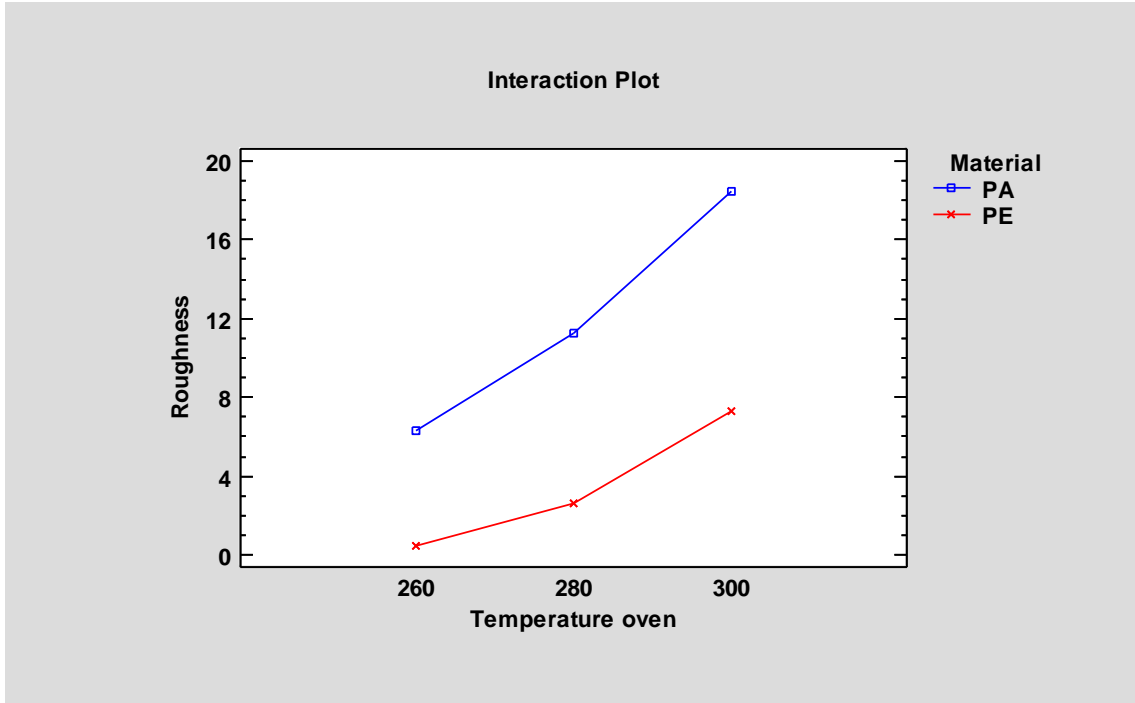

A 5 Interaction plot of temperature of the oven and time induction.

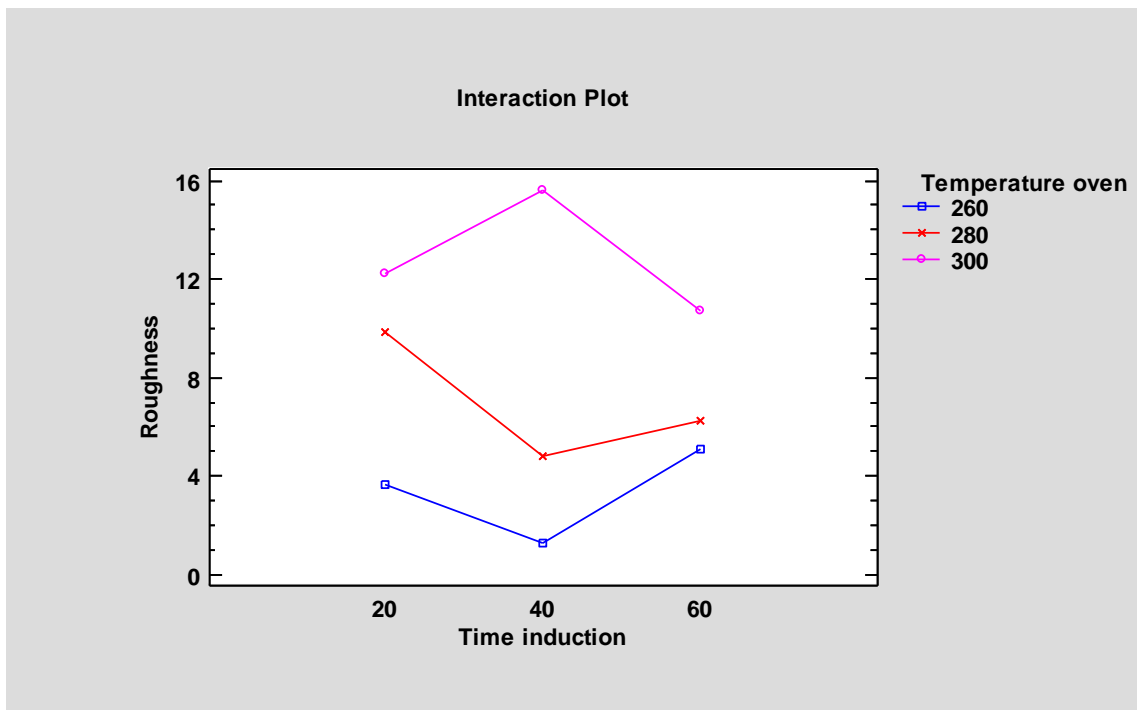

A 6 Final part obtained from the automated process





## 10 Statement of academic honesty

I hereby declare to the best of my knowledge that this thesis contains no material previously published or written by any other person. The work submitted in this thesis is the product of my own original research, except where I have duly acknowledged the work of others.

---

City, Date

---

Signature