

# **Technical University of Dresden**

Faculty of Mechanical Engineering

Professorship for Fluid-Mechatronic Systems Engineering

## **Master thesis**

**Theme: Methodology development for the cost-benefit analysis of pneumatic and electromechanical drive structures**

submitted by: **Cristina Pascual Rico**  
born on 09.01.1994 in Valladolid

University professor: Prof. Dr.-Ing. Jürgen Weber

Supervisor: M. Eng. Vladimir Boyko

Date of submission: Dresden, 23<sup>th</sup> of September 2019

**Task with original signature (Aufgabenstellung!)**

**Table of contents**

Table of contents .....	III
List of abbreviations .....	1
List of figures and tables.....	2
1 Introduction .....	5
2 State of research .....	7
2.1 General definitions .....	7
2.2 Cost components.....	11
2.2.1 Cost division.....	11
2.2.2 Depreciation .....	12
2.3 Considered technologies .....	16
2.4 Comparison methods of pneumatic and electromechanical drives .....	21
3 Motivation, objective.....	22
4 Research: Technical side.....	24
4.1 Mechanical properties analysis.....	24
4.2 MPE Algorithm.....	25
5 Research: Economical side .....	37
5.1 TCO Methods .....	37
5.2 Installation definition.....	40
5.3 Economic cost analysis .....	42
5.4 Maintenance strategy.....	47
6 Combination of economical and technical sides to one method .....	55
7 Conclusion and outlook .....	60
8 Literature.....	63
9 Annex.....	A-1
9.1 Table of shipping costs.....	A-1
Declaration of authorship.....	A-2

**List of abbreviations**Abbreviations

LCC	Life cycle cost
TCO	Total Cost of Ownership
OLCCA	Overall Life Cycle Comprehensive Assessment
ABC	Activity based costing
Dpmo	Defects per million opportunities
LCCABOU	Life cycle cost analysis based on users

---

## List of figures and tables

### Figures

Figure 1: Stages of a life cycle of a product .....	7
Figure 2: Scheme of cost components.....	11
Figure 3: Compressed air installation.....	16
Figure 4: Block diagram of an electromechanical drive .....	19
Figure 5: Main components of an electromechanical drive .....	20
Figure 6: Method stages for the mechanical properties analysis.....	25
Figure 7: Cost type by the original algorithm.....	28
Figure 8: Efficiency type by the original algorithm .....	29
Figure 9: Interval type by the original algorithm .....	29
Figure 10: Fixed type by the original algorithm.....	30
Figure 11: Interval type by the corrected algorithm.....	31
Figure 12: Interval type by the improved algorithm .....	31
Figure 13: Fixed type by the improved algorithm.....	32
Figure 14: Values for E per alternatives.....	35
Figure 15: Electromechanical drive .....	40
Figure 16: Pneumatic drive with meter-out control .....	41
Figure 17: Acquisition cost in € per drive.....	43
Figure 18: Energy costs in € per drive per year.....	43
Figure 19: Costs in perfect functioning situation and in stop situation.....	44
Figure 20: Maintenance costs in € per drive per year.....	45
Figure 21: Scheme of selection of the maintenance strategy.....	47
Figure 22: MTTF, MTTR and MTBF over the life cycle.....	49
Figure 23: Evolution of the process under RCM strategies.....	51
Figure 25: Evolution of the process under RBM strategies.....	52
Figure 27: Evolution of the process under TPM strategies.....	52
Figure 28: Accumulated cost per strategies for a medium process .....	53

Figure 29: Drives layout.....56

Figure 30: Results of the alternatives after analysis for task 1.....57

Figure 31: Results of the alternatives after analysis for task 2.....58

Figure 32: Results of the alternatives left after Pareto analysis for task 1.....59

Figure 33: Results of the alternatives left after Pareto analysis for task 2.....59

Figure 34: kg CO<sub>2</sub> emitted over 5 years for the selection of alternatives for task 1.....60

Figure 35: 3D graphic with the alternatives represented in each field for task 1.....61

Figure 36: 3D graphic with the alternatives represented in each field for task 2.....61

Tables

Table 1: Fraction of value depreciated per year by the straight line method..... 13

Table 2: Fraction of value depreciated per year by the Sum of the digits method..... 14

Table 3: Fraction of value depreciated per year by the declining method..... 14

Table 4: Quantifiable and qualitative properties .....25

Table 5: Qualitative properties .....26

Table 6: Matrix of values of the characteristics U.....26

Table 7: Standardization algorithm by the OLCCA article.....27

Table 8: Matrix of values of the characteristics U.....28

Table 9: Standardized values R.....33

Table 10: Normalized values  $\hat{R}$  .....33

Table 11: Information entropy vector attributes E.....34

Table 12: Values for  $\omega$  per charcateristic .....35

Table 13: Vector S.....36

Table 14: Costing methods .....38

Table 15: Work conditions .....40

Table 16: Component overview of electromechanical drive .....40

Table 17: Component overview of pneumatical drive .....41

Table 18: Origin of funds and combined rate of interest.....46

Table 19: External and internal activities for pneumatical drives .....48

Table 20: Maintenance strategies.....50

Table 21: Quality level of a process according to its sigma level.....50

Table 23: Given operation conditions for the practical case .....56

Table 24: Mechanical properties to be analysed .....57

Table 25: Alternatives to be analyzed .....57

Table 26: Comparison of alternatives by pairs .....58

## 1 Introduction

### **Present Context: Industry 4.0**

The current context is strongly marked by Industry 4.0, also known as the Fourth Industrial Revolution. The concept of Industry 4.0 refers to the digital transformation of industry, giving rise to a new organizational model and a change that breaks the conception of traditional industry. An organisational model is understood as a combination of manufacturing technology and management.

This new organizational model has four fundamental mainstays: sensorization, storing, information analysis and artificial intelligence. And it requires industries to implement a fast, flexible working method, capable of following the market, detecting trends and responding quickly to demand, and for this purpose it is essential automatization and monitoring of processes.

In this new industrial environment, in which the production equipments are intercommunicated with each other, with the environment, with the products and with the workers; it is necessary for the equipments to be flexible, able to adapt and take decisions to maximize productivity, avoid or correct problems depending on the information they receive.

Another important point, due to the cost savings it entails, is the intelligent maintenance of the machines, by which they themselves monitor their state. With the implementation of an adequate maintenance strategy, it will be possible to identify problems, anticipate risks, correct situations of insecurity and take the necessary actions in time. All this with the aim of reducing to a minimum the waste of both time and material, while guaranteeing maximum quality.

For all these reasons, the choice of the right production technology becomes essential. Each technology has advantages and disadvantages, and each individual case must be studied, as the right choice will help to ensure optimum actuator quality and longevity.

In addition, an aspect that is becoming increasingly important and that the company must take into account in its election is the environmental commitment, aiming to minimize or eliminate the impact on the environment of the activities performed.

In this transition it is fundamental for the company to find in its chosen alternative a balance between the economic aspect, which is always a limiting factor; the mechanical properties offered by each technology, so that the characteristics are adjusted as much as possible to the requirements of the process; and the environmental impact generated.



---

## **Technology competition**

In this context, the competition between two actuator technologies is presented: pneumatics and electromechanics.

In automated systems, pneumatic cylinders have been an excellent alternative due to their low operating costs, but in recent years electrical technology has imposed itself on pneumatics due to some advantages e.g. higher level of precision and control.

However, this does not mean that electrical technology is the most suitable alternative for all cases.

For durability at low cost specialists often choose pneumatic actuators. While, to guarantee greater control and precision to the systems, although at a higher cost, electromechanical actuators are usually chosen.

## **Life cycle cost analysis**

Compared to the higher initial cost for the purchase and commissioning of electrical systems, it is easy to think that pneumatic technology will be a more economical option. However, more factors need to be considered to make the right choice. In order to do this, it is necessary to expand the variables considered, forming a global vision of all the costs reflected throughout the useful life of the actuator.

This way, the concept of Total Cost of Ownership (TCO) is introduced, which also considers the operation and maintenance costs due to the use of this technology throughout its useful life.

When considering the costs throughout the life cycle of the actuator, the differences go far beyond the source of energy required to generate motion. There are many other costs associated with one technology.

However, these costs are not all fixed, they can be influenced to reduce them. Some options are: the control of losses, to achieve greater efficiency of the actuators; or the selection of an optimal maintenance strategy.

Factors such as cost of acquisition, mechanical suitability, energy efficiency and maintenance strategy will be considered in this article.

## 2 State of research

### 2.1 General definitions

In the following section the main concepts and terms are introduced and defined.

**Cost.** As defined in /Mall99/: *"The cost of a good or a service is the sacrifice of values related to obtaining or providing said good or service."*

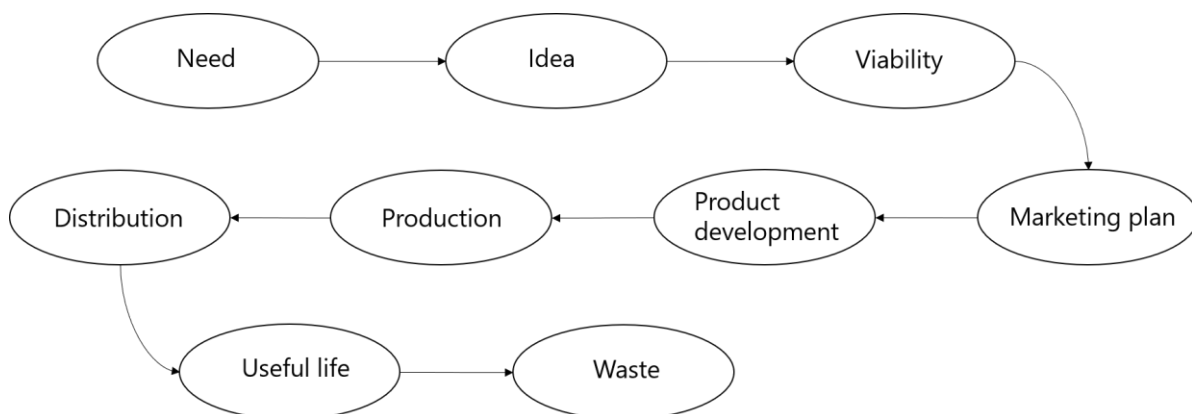
There are two main types of costs: direct and indirect costs as defined in /Cr92/.

**Direct costs:** can be assigned directly to the manufacture of a product, so they are proportional to the amount of product manufactured. Usually represent the highest percentage of the final total cost.

**Indirect costs:** cost that cannot be directly assigned to a single product as it affects a whole process or is necessary as a support. Some criteria is needed for the distribution of indirect costs on each product.

**Life Cycle of a Product.** Stages through which a product will pass from the moment it is conceived as an idea until the end of its useful life. It includes from the first stages of conception and definition in the organization that produces it, through its manufacture, its sale and its useful life; and finally its removal and disposal as waste. /Rib02/

These stages of a life cycle of a product are:



**Figure 1:** Stages of a life cycle of a product

- 1) Search for the need and definition of the idea. A need is detected and from it one looks for to cover some requirements of the client, among them of functionality, specifications or aspect. A market to which it will be directed is defined, a buyer profile. It is essential to carry out a complete analysis of the competence, both of substitute and complementary products. The technical viability of the proposed ideas is analysed. And also a profitability analysis, to determine the benefit it will bring to the company.
- 2) Selection of an idea and its development as a product. Shape the selected alternative through different analysis: SWOT analysis: weaknesses, threats, strengths and opportunities; analysis of financial forecasts: to determine the impact on the accounts; deeper market study.
- 3) Condition of viability, both economic and technical. Analysis of financial forecasts, to determine the impact on the accounts, the cost-benefit balance. And technical analysis, to define the technology that will be used.
- 4) Marketing plan. Definition of the distribution and marketing channels, sales forecasts, establishment of a sale price and specification of the objectives of that product.
- 5) Product development. It is the longest stage and consists of making the idea tangible. Determine the design, parts, assembly, processes, finishes, etc. Prototypes are used to test their performance and compliance with customer specifications before producing on a large scale. This stage is fundamental to determine costs and environmental impact.
- 6) Production. Carries the highest percentage of costs. Production on a large scale, definition of a production model adjusting times and costs.
- 7) Distribution. Make the product reach the buyer: logistics, transport, points of sale...
- 8) Useful life. Period in which the asset satisfactorily fulfils the function for which it was created
- 9) Waste. Asset with no value after its useful period from which its owner falls apart. Depending on the nature of the asset, the waste may require subsequent disassembly treatment. These post-treatments correspond to the user or the community.

## Methods definitions

The union of these two ideas: costs and life cycle of a product, gives rise to a global concept that aims to quantify the cost of a product not only at a moment, but throughout its period of existence.

There are two definitions in the modern literature which seek to collect this global concept of cost of a product over time: Life Cycle Cost and Total Cost of Ownership.

However, the difference between these two concepts is not clear in the literature, as the concepts overlap or are used indistinctly, which is why a research has been carried out to define the limits of each concept.

**Life Cycle Cost.** Sum of the costs due to the activities that must be carried out on the product at each stage of its life cycle. As its explained in the article /Ba95/, these costs of a product or service throughout its life cycle can be easily identified and assigned if it involves costs associated with its production or direct costs: raw material, labour, machinery or energy, so these costs will be proportional to what is produced. But they can also entail indirect costs associated with many different factors e. g. waste treatment, pollution rates.

As explained at the beginning, the direct costs correspond mostly to the production and distribution phases of the product.

The indirect costs are associated to the first and final phases, as well as the support to the process: conception and definition, design, safety, disassembly, waste treatment, recyclability, etc.

**Total Cost of Ownership.** Model to analyse the direct and indirect cost of owning and using an asset from the point of view of the customer that acquires that asset. Thus, for the customer the costs will begin with the costs of acquisition, shipping and installation. In the next stages the costs due to their operating conditions and maintenance strategy will have to be considered. And at the end of the useful life the costs of uninstallation and disposal. It's a long-term evaluation. The item with the lowest total cost of ownership is the best long-term value. /Twin19/

## Main difference between LCC and TCO

The main difference lies in the point of view from which the costs are analysed, each of which is of interest to different users. That is, for a different use of the information. While the Total Cost of Ownership is from the customer's point of view to help them make their forecasts. The Life Cycle Cost, from the manufacturer's point of view, help to predict the impact their product will have as

costs to their company from its conception through all the stages of which he has to take charge and which involve him.

As a conclusion, Total Cost of Ownership has been chosen to represent costs over time as it best fits the objective of defining the costs that the company will have to face as a result of choosing a production technology, and is therefore the most appropriate concept for comparing technologies.

### **Utility of TCO**

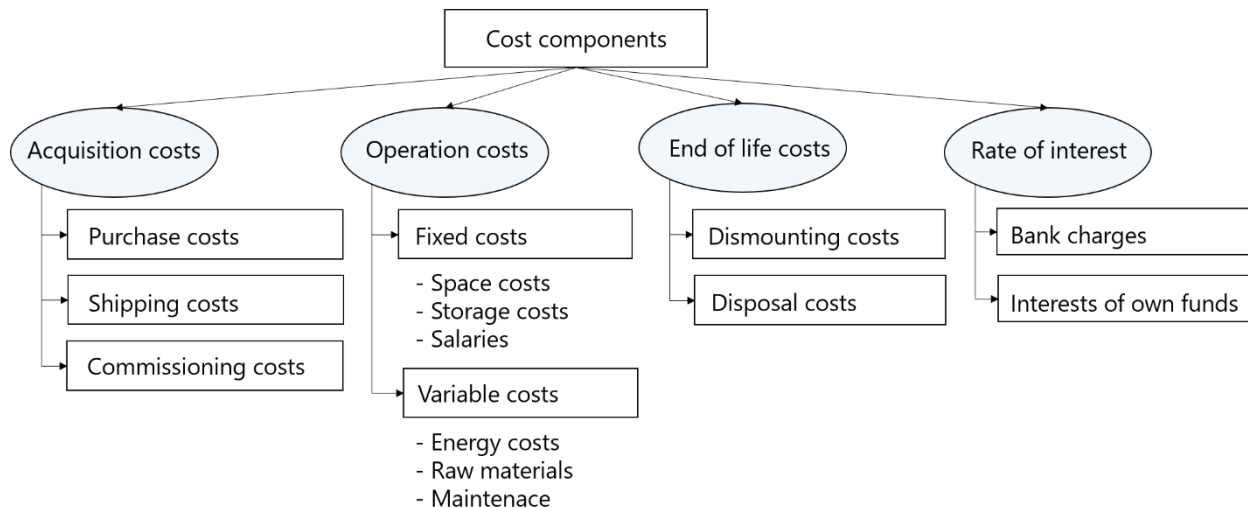
The purpose of the Total Cost of Ownership concepts is to provide the buyer with the maximum possible information to make the best purchase choice, condensing in the smallest possible number of the total real cost that implies the purchase of a product and its value sequence over time.

TCO takes into account certain criteria that the user must know according to their priorities. For example, consider the environmental impact or not. But after the analysis and the presentation of the results, it is up to the user to choose the most suitable alternative according to his priorities.

## 2.2 Cost components

### 2.2.1 Cost division

The cost components are presented according to the main phase of the life cycle to which they are assigned. This way the cost components are /Bra09/:



**Figure 2:** Scheme of cost components

**A. Acquisition costs.** Initial investment for the beginning of the activity. Is the total cost to buy an asset, including taxes, costs of preparation, installation and testing. Five important subtypes can be differentiated:

A.1. Purchase cost. Sale price of an asset in the market.

A.2. Shipping costs. Costs of sending the goods.

A.3. Commissioning costs. Start-up of the asset, including transportation, installation and testing.

**B. Operating costs.** Expenses derived from carrying out the main activity of the company and its auxiliary activities on a day-to-day basis. From the analysis of the operating costs, improvements for a more efficient operation could be studied. Components of operating costs:

B.1. Fixed costs. They do not depend on production, they remain constant and must always be faced. They can be reduced but will not be eliminated. These costs include:

- Salaries

- Space costs. Cost of physical space occupied in the layout by the chosen technology. It is estimated as required area times the cost per quadrante meter.

- Storage costs. Cost of physical space required for safety stock.

B.2. Variable costs. Costs directly related to production, vary with the decrease or increase in the amount produced, since they refer to the resources used. These costs are:

- Energy costs

- Maintenance costs

- Raw material

### **C. End of life costs.**

C.1. Dismounting costs. Due to the removal of the equipment from the installation at the end of its useful life.

C.2. Disposal costs. Due to the correct management of waste in accordance with its characteristics, minimising its environmental impact and respecting current environmental legislation.

**D. Rate of interest.** It is the cost of using funds over a period.

D.1. Bank charges. There are several types of depreciation of interest on a loan, these will depend on the conditions of the contract with the bank and the interest rate for loans or bank charges.

D.2. Interests of own funds. The interest rate for use of own capital returned to investors must be higher than the opportunity cost of employing the funds in another activity.

These cost components have different calculation possibilities. Which means different methods of allocation of variable costs and different methods of depreciation of assets can be taken.

The election of the allocation methods of costs and depreciation will be justified in the following paragraphs of the article.

### **2.2.2 Depreciation**

Once the costs have been calculated, the real value over time for the equipment needs to be known, since they lose value for several reasons: materials, use and wear; obsolescence, appearance of new technology and variation of demand.

Depreciation. *"It is the financial process through which a debt is gradually extinguished through periodic payments, which may be the same or different" /Per17/.* This reflects the annual wear of an asset in order to distribute its value in the periods in which it remains.

Depreciation is intended to ensure that the calculation of the profit is correct by taking into account all the expenses for the year, including the deterioration of fixed assets during the year.

Deductible amounts are considered as depreciation of property, plant and equipment when they correspond to the effective depreciation suffered by the various elements due to their operation, use, enjoyment or obsolescence.

A depreciation method will be chosen. According to /Ye08/, there are three main types of amortization for industrial machinery:

#### 1) Straight line method.

Assets are depreciated through equal quotas each year, so the amortization expense will be constant. There are two forms of calculation:

Assignment of a Percentage: an annual coefficient is assigned that is applied on the acquisition value.

$$\text{Annual depreciation} = \text{Acquisition value} \cdot \text{Coefficient (\%)}$$

And distribution throughout the useful life: the years in which the good is expected to generate income are estimated and the initial cost is divided among the useful years:

$$\text{Annual depreciation} = \frac{\text{Acquisition value} - \text{Residual value}}{\text{Years useful life}}$$

For each type of asset, the tax agency establishes a maximum linear coefficient and a maximum number of years of useful life, so the annual amount to be deducted is limited.

The main advantage of the linear method is its ease of hourly calculation, that is, the cost of running machines and resources per hour of production. Its disadvantage is that it does not adjust to the real market value of the machinery. /Ye08/

As a disadvantage, this method underestimates the actual resale value.

**Table 1:** Fraction of value depreciated per year by the straight line method

Year	1	2	3	4	5	Sum
Depreciation rate	1/5=20%	20%	20%	20%	20%	1
Depreciation	1.800,00	1.800,00	1.800,00	1.800,00	1.800,00	9.000
Remnant	7.200,00	5.400,00	3.600,00	1.800,00	-	9.000



## 2) Sum of the digits method.

Method that generates decreasing quotas without residual value. The annual coefficient is the numerical value of the period starting with the highest, divided by the sum of the digits up to the number of years of useful life.

As an example: active with a useful life of 5 years.

Sum of the digits:  $1 + 2 + 3 + 4 + 5 = 15$

The annual depreciation coefficient will be:

**Table 2:** Fraction of value depreciated per year by the Sum of the digits method

Year	1	2	3	4	5	Sum
Depreciation rate	5/15	4/15	3/15	2/15	1/15	1
Depreciation	3.000,00	2.400,00	1.800,00	1.200,00	600,00	9.000
Remnant	6.000,00	3.600,00	1.800,00	600,00	-	9.000

As an advantage, it provides a good real adjustment to the market value. But as a disadvantage it is not useful for estimating the hourly cost of production, since the hourly costs would not remain constant over time, but would be lowered each year with the reduction of the depreciation percentage. And the company is interested in having constant costs for their planification and profitability analysis, so it approaches more to reality.

## 3) Declining method.

Suitable for assets with very short life cycles, from 2 to 4 years. the depreciation coefficient is adjusted each year according to the rule of the method. The annual depreciation coefficient will be double the linear applied on the remnant. This method leaves a residual value at the end of depreciation.

As an example: active with a useful life of 3 years. The annual depreciation coefficient will be:

**Table 3:** Fraction of value depreciated per year by the declining method

Year	1	2	3	Sum
Depreciation rate	$2/3=66.66\%$	66.66%	66.66%	-
Depreciation	6.000,00	2.000,00	666,67	8.676,57
Remnant	3.000,00	1.000,00	333,33	-

Its main advantage is that it adjusts very well to the real market value, leaving a residual value at the end. As a disadvantage, for such short life cycles it does not comply with the annual maximum coefficients established by the tax agency.

The depreciation method chosen is the straight line one as indicated in the report of the consultant /EY16/ according to the German legislation for fixed assets. In the case of industrial machinery, is important to calculate production costs, so the straight line amortization method fits the best for this calculations, in addition to not anticipating a sale of machinery, so it is not relevant that it does not adjust to the real value of market.

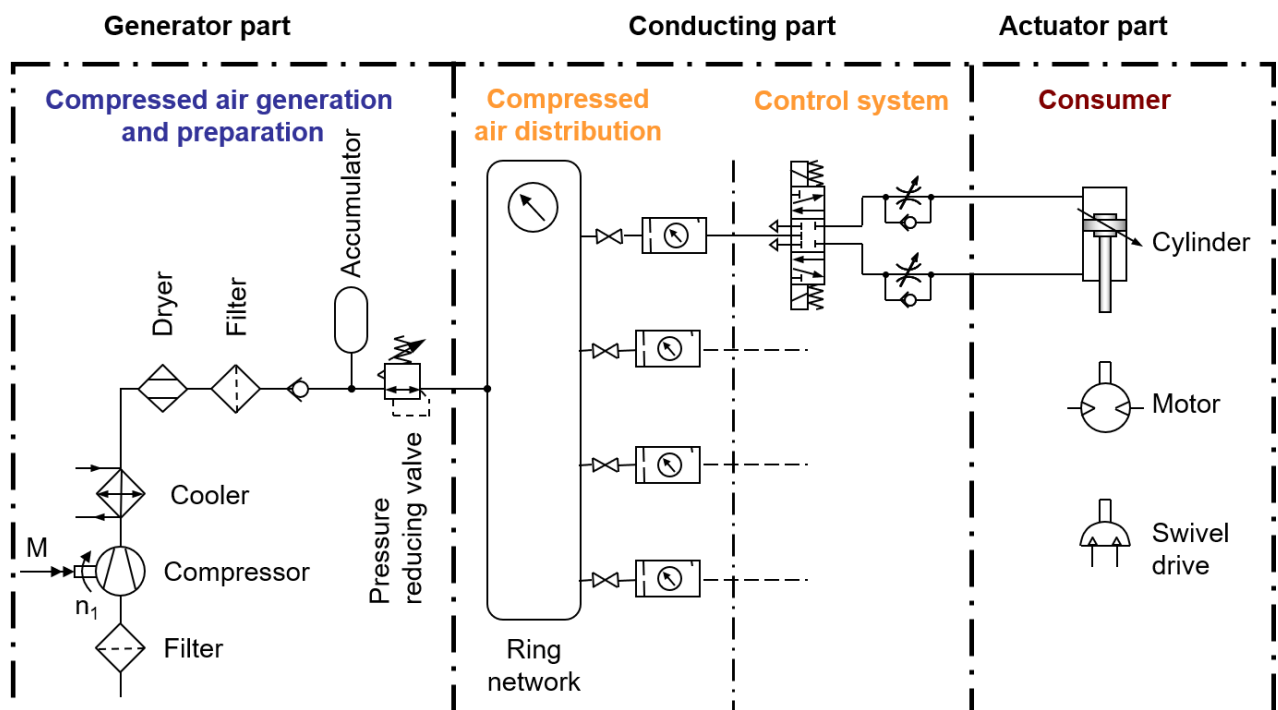
## 2.3 Considered technologies

As the choosing between pneumatics and electrics is considering, the main characteristics and terms of each technology should be defined.

### Pneumatic

The pneumatic transmission systems work by modifying the pressure and volume of air, being able to perform rotary, linear and swivel movements.

The installation has three main parts: /Web19/



**Figure 3:** Compressed air installation

#### a) Generation: Compressed air installation

The pneumatic or compressed air installation aims to supply pressurized air to all the machines that need it in order to operate.

b) Distribution: compressed air distribution ducts from where it is generated to where it will be used. Here is where most losses occur.

Functioning. In order for the air to reach optimum conditions of use, the compressed air generated by the compressor is passed through a separator, which retains most of the suspended water contained in the air and then accumulates it in the tank and can be passed on to the distribution network.

The network of pipes carries the compressed air to the feeding points. Pipes are sealed together to prevent pressure losses.

The conditioning unit consists of three fundamental parts:

- Filter: Retains the impurities and water vapour that the air carries in suspension.
- Regulator: Establishes and maintains the supply pressure.
- Lubricator: to reduce the friction of the pneumatic elements and reduce their wear (rarely used nowadays).

Another main components are:

One-way flow control valve. Regulate the speed of the piston in the advance and the return through the restriction of the flow of compressed air supplied. The control function works only in one direction, and the non-return works in the opposite direction.

Directional control valve, which allow to direct the fluid flow from one or more sources to different routes.

c) Actuation: where the force is transmitted by making a movement.

Cylinder. Formed by a disk that moves pushed by the compressed gas and by a rod that transmits the force. Cylinders of single and double effect can be distinguished, with one or two air intakes respectively. The simple cylinders produce forward movement only by returning to their original position by the action of a spring. While the doubles thanks to its two air inlets produce forward and backward movement.

They can also perform rotary and swivel movements. In rotary drives the energy of the compressed air is converted directly into a rotational movement through the vane and does not require an additional transmission ratio, reaching a rotation angle of  $270^\circ$  /Festo/. In swivel drives or semi-rotary drives, the force is transmitted directly to the drive via a rotary vane. The swivel angle is adjustable from  $0$  to  $184^\circ$ . /Festo17/

Among its major advantages, the first to stand out is the lower initial unit cost of a pneumatic actuator. They can be used in applications with dangerous environment, as they stand explosions, shocks, sparks and humid environments. They are also used in applications where variable and very high speeds are needed.

But they also have some characteristics that put them in disadvantage in front of their competitors. The air is plentiful and cheap, but it needs to be compressed by an additional installation compressor that works with electricity. They also require leakage control, elimination of air

impurities giving a low efficiency. So the investment difference is not maintained in the long term due to higher energy costs. On the mechanical side they have less precision than the electromechanical ones. And finally, on the environmental side, the additional energy required by the pneumatic cylinder means higher CO<sub>2</sub> emissions.

New trends in the field of pneumatic drives to make them more competitive are aimed at increasing their efficiency, controlling and reducing losses. /Web19/

Despite the fact that air is a clean and unlimited resource, the generation of compressed air is a great cost. Here is where pneumatic technology has evolved: in the efficiency of generation in compressors, in order to provide more sealed products, which properly dimensioned do not generate leaks.

This way the pneumatic technology can nowadays be competitive, clean and low cost against its competence.

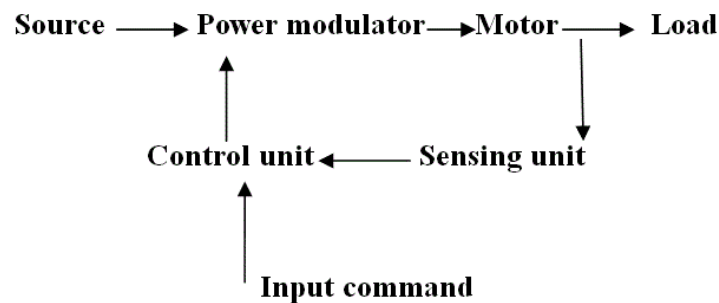
## Electromechanical

Electromechanical actuators convert electrical energy into mechanical energy. They consist of a simple structure, since they only require electrical energy as a source of energy.

Electricity and control signals are transmitted via electrical cables, covering long distances between the energy source and the actuator.

Parts of an electromechanical actuator:

1. Power source
2. Power modulator
3. Motor
4. Control unit
5. Sensing Unit
6. Input command
7. Load

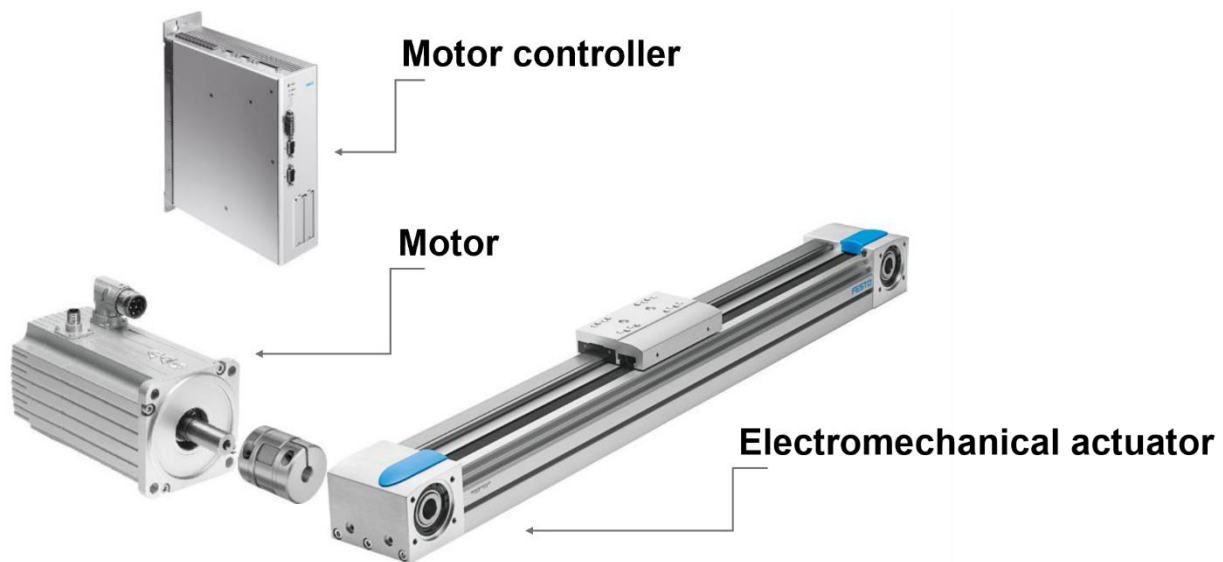


**Figure 4:** Block diagram of an electromechanical drive

Functioning. The power source can be monophasic or triphasic. The power modulator alters the energy according to the motor requirement and the motor moves the moving element that is displaced.

The control unit, working in a closed loop operation, adjusts the operating point of the drive by receiving an input command signal and the signal from the sensing unit, which senses a certain drive parameter.

The reprogramming mode by incoming commands gives them a fast response and great versatility.



**Figure 5:** Main components of an electromechanical drive

The advantages of electromechanical actuators over pneumatic are:

Although the initial unit cost of an electric actuator is higher they don't require special installations as they use electricity directly and the cost difference is recouped by energy savings in a few months in a typical system. Its maintenance is more expensive because it is more specialized, but less frequent.

On the mechanical side, they are highly precise, changes are programmed and therefore quick. They have a very long service life, so they do not need to be changed frequently. They are quieter than pneumatics and there are no leaks, resulting in a higher efficiency.

On the environmental side, they contribute to a reduction of CO<sub>2</sub> released into the atmosphere as they have a lower energy consumption.

However, it is not as suitable for dangerous environments, as there is a danger of overheating, and has speed limitations, working only at moderate and fixed speeds. Another disadvantage of electromechanical drives is that during the holding of parts with a force they consume electricity all the time. In contrast to the pneumatic drives, which do not require compressed air during the entire holding time.

## 2.4 Comparison methods of pneumatic and electromechanical drives

In the study of the current methods of comparison between pneumatics and electrical, several scientific articles have been used as a reference.

*/Xue17/* analysis three fundamental aspects: mechanical properties, economic cost and environmental impact. It performs a separate analysis in each area but does not provide a relationship between them, resulting in an isolated analysis, not a global one.

The main goal of the study */Mer17/* was a guideline development to help industrial users to select the most energetically and economically viable drive technology for their particular application by the considering of the total cost of a motion task performing. The disadvantages of this study were that they considered only quantifiable factors, didn't consider the environmental impact and various possibilities for air consumption reducing of pneumatic drives.

*/EnEffAH12/* The project focuses on the development of methods and tools to ensure energy-efficient automation in pneumatic and electric drives. It presents alternatives throughout the functional chain of drives and their savings potential to help industrial users assess energy efficiency in their own applications. However, there is no economic study of the entire actuator that reflects all the costs involved in its use.

As a conclusion of the research it found that the current articles focus on a single criterion of choice or on a single part of the life cycle. But they do not consider the comparison of several aspects at the same time, nor do they present proposals to reduce costs in the long term.

There are already some methods which are scientifically described, but they are not just used widely in the industry. As there is no standardized method for TCO-based comparison between pneumatics and electrics so far in the market, a new method is created taking into account all aspects that concern the user and that will affect him in the form of costs throughout the time he uses the asset, thus providing the greatest amount of information for the objective decision making.



### 3 Motivation, objective

The choice of the manufacturing technology to be implemented is an important decision that will determine the productivity of the company. From here on, the importance of choosing the right alternative, covering the requirements of the system while guaranteeing its economic efficiency.

This choice is a multivariable problem in which a large number of variables have to be taken into account, both in the short and long term.

In this article three main criteria of choice are taken to cover the basic needs over the complete life cycle of the actuators. These criteria are each focused on an area to solve:

- Mechanical properties. Equipment characteristics to fulfil working conditions.
- Economic costs. Objects that are the cause of costs due to the consume of resources and criteria for their distribution.
- Environmental impact. Emissions or wastes due to industrial activity that have a negative impact on the environment.

In order to find the device that best fits the requirements of the user different combinations of these criteria can be taken, so the chosen solution must cover the needs of the user as completely as possible in the different areas or, at least, in the most balanced way.

The difficulty of the analysis lies in the fact that among the characteristics presented there are characteristics of two classes: quantifiable, e. g. speed, pressure; and qualitative, e. g. structure complexity, flexibility of changes. Therefore, the data must be processed before conclusions can be extracted from them. The quantifiable data must be normalized in order to be compared, which means that all the data can be measured on the same scale. In addition, among the quantifiable data there are subtypes depending on the objective of the variable.

This article aims to create a method that completes the ones studied until now: taking into account more variables, more life cycle stages, adding improvements and comparing strategies.

All of this with the motivation of presenting the user the maximum amount of information with the minimum number of data, in order to facilitate their choice process.

A more objective, applicable and user-friendly method is used than the previous ones, using temporal and schematic graphs, in which the user can have at a single look all the determining aspects for an easy choice and evaluate the degree of conformity with in the different areas.

In addition, the proposed analysis has the advantage that it aims that the user has as little influence as possible on the result and only has to make the final decision. So the algorithm will start from

the user's data and from them it will offer different combinations of solutions, weighing the most determining factors by itself.

## 4 Research: Technical side

### 4.1 Mechanical properties analysis

When the user is faced with the choice of an automation technology there are a lot of parameters to be considered (e.g. speed, energy consumption) in order to choose the best possible alternative for this task.

In these cases, where the aim is to maximise performance in several fields at the same time, it is referred to as a multi-objective optimisation problem. The one possibility to solve this problem is explained in the guideline VDI 2255 "Technisch-wirtschaftliche Bewertung" /VDI98/. In this guideline, under the "technical-economic concept", different methods are used to "structure" the designer's task, not only technically, but also economically, aiming to create more profitable and high quality products.

This method has the advantage that it is simple but not complete, as it only accounts manufacturing costs.

It has the disadvantage that the weight of each characteristic has to be setted by the user in advance, which supposes a total influence of the user on the decision making. So its main disadvantage is its subjectivity.

In the technical evaluation the allocation of points for technical properties is used: between 0 and 4 (ideal). Based on the given points, the score of each technical characteristic is calculated as the ratio of the total number of points obtained for each alternative divided by the sum of the points of an ideal design.

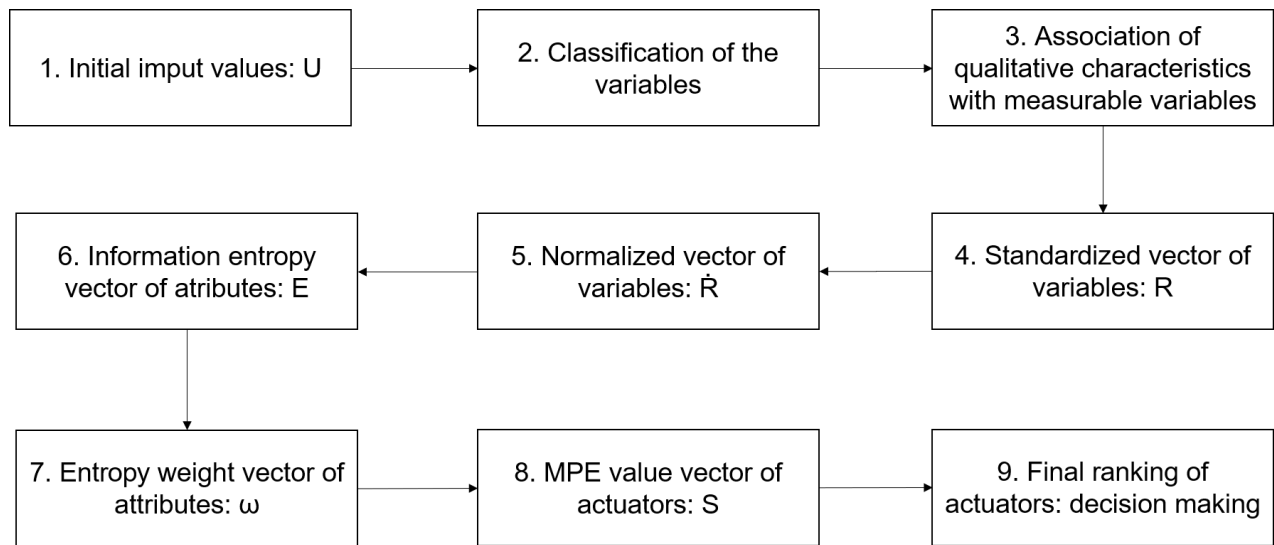
This method is therefore discarded and for the analysis of the mechanical properties the MPE (Mechanical Properties Evaluation) method from the /Zha14/ article is chosen, since the method of this article has an algorithm that does not need to be influenced by the user. The multi-objective optimisation problem is solved by applying combined entropic methods of information processing and fuzzy logic to find an algorithm that collects the maximum amount of information.

Fuzzy logic defines fuzzy sets, with imprecise limits. Thus, the elements of a fuzzy set are allowed to have a degree of belonging to that set. In this way, the belonging of an element to a diffuse set will not be a binary matter, but a gradual one, as defined in the article /Ath09/.

Information entropy measures the degree of randomness of data in terms of probability distribution of information. Its purpose is to obtain the maximum useful information from the data provided by modifying the weight coefficients. The method application is explained step by step in the following section 4.2.

## 4.2 MPE Algorithm

The main stages of the mechanical evaluation algorithm proposed in /Zha14/ will be as follows:



**Figure 6:** Method stages for the mechanical properties analysis

However, the article is incomplete as it has some gaps. Firstly, it does not take qualitative variables into account. And secondly, there are some mathematical errors in the MPE algorithm formulas. These problems will be solved in the following sections.

In order to solve the first problem, variables are classified in quantifiable or qualitative. There are two types of cost components: quantifiable, which are measurable or tabulated; and qualitative, which cannot be measured directly, and some election criterion is needed to determine if it fits or not the established requirements.

For the study the following mechanical characteristics will be considered:

**Table 4:** Quantifiable and qualitative properties

Mechanical properties	Quantifiable	Qualitative
Structure complexity		✓
Mass	✓	
Dimensions	✓	
Speed	✓	
Power density ratio	✓	
Useful life	✓	
Position accuracy	✓	
Flexibility of changes		✓
Temperature range	✓	
Humidity range	✓	

In order to take into account all possible variables, the study is extended by adding variables that are not directly quantifiable. For this purpose, qualitative variables are related to measurable variables, justifying their logical relationship of dependence. Association of qualitative characteristics with measurable variables.

**Table 5:** Qualitative properties

<b>Mechanical properties</b>	<b>Associated variable</b>
Structure complexity	Cost per drive
Flexibility of changes	Inactive times (time to reprogram)

In order to validate the described algorithm, an example with 4 possible alternatives of pneumatic drive structures for the fulfilling of a specific movement task with 5 mechanical characteristics have been taken. It should analyse the suitability of the algorithm for multi-objective problem solution.

The matrix of values of the characteristics is taken as a starting point:  $U = (u_{ij})_{p \times n}$ .

**Table 6:** Matrix of values of the characteristics U

	Initial values: <b>U</b>			
Characteristic	Solution 1	Solution 2	Solution 3	Solution 4
Compressed air consumption, NI/cycle	0,9988	1,006	0,9983	1,2
Movement time forwards, s	0,12	0,18	0,16	0,15
Movement time backwards, s	0,465	0,3	0,7	0,9
Pressing force forwards, N	260	280	250	290
Pressing force backwards, N	55	97	90	60

The next step is the standardization of the variables, a linear scale transformation is used. The values of the qualitative variables cannot be influenced, they are given by the manufacturer. They are measured and a value is obtained.

Each type of quantitative variable requires a different standardization depending on the objective of the variable. The /Zha14/ classifies the quantifiable data into four types:

- Cost type: The smaller the better e. g. compressed air consumption [NI/cycle].

- Efficiency type: The bigger the better e. g. pressing force forwards, [N].
- Fixed type: it is important to keep it constant e. g. movement time forwards, [s].
- Interval type: interests the amplitude of the range in which it is valid e. g. pressing force [N].

**Table 7:** Standardization algorithm by the OLCCA article

Cost type	Efficiency type
$r_i = \frac{U_{min}}{U_i}$ <p>Where: <math>U_{min}</math> is the minimum of attributes.</p>	$r_i = \frac{U_i}{U_{max}}$ <p>Where: <math>U_{max}</math> is the maximum of attributes.</p>
Interval type	Fixed type
$\left[ \begin{array}{l} r_i = 1 - \frac{U_i}{c_1}, \quad U_i \in [U_{min}, c_1) \\ r_i = 1, \quad U_i \in [c_1, c_2] \\ r_i = 1 + \frac{c_2}{U_{max}} - \frac{U_i}{U_{max}}, \quad U_i \in (c_2, U_{max}] \end{array} \right.$ <p>Where: <math>c_1</math> and <math>c_2</math> are the interval limits, <math>U_{max}</math> is the maximum of attributes, <math>U_{min}</math> is the minimum of attributes.</p>	$\left[ \begin{array}{l} r_i = \frac{U_i}{c}, \quad U_i \in [U_{min}, c] \\ r_i = 1 + \frac{c}{U_{max}} - \frac{U_i}{U_{max}}, \quad U_i \in [c, U_{max}] \end{array} \right.$ <p>Where: <math>c</math> is the fixed value, <math>U_{max}</math> is the maximum of attributes, <math>U_{min}</math> is the minimum of attributes.</p>

According to this classification, the given characteristics can be divided into:

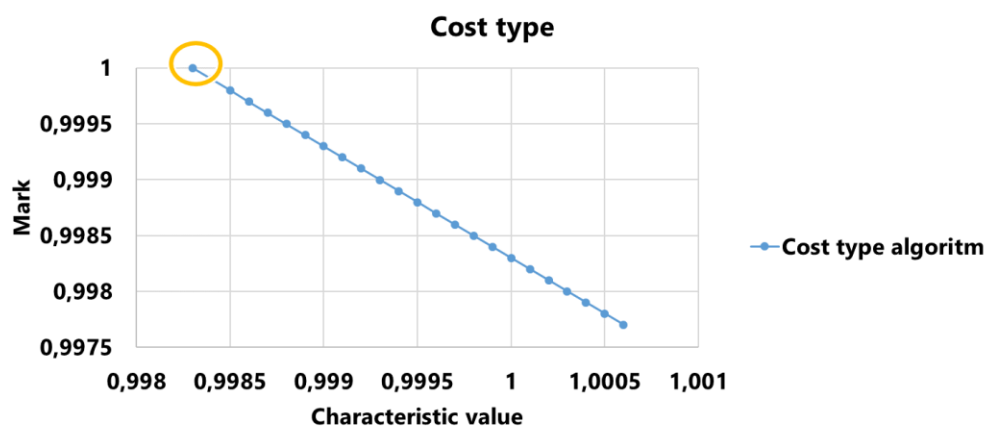
**Table 8:** Matrix of values of the characteristics U

Characteristic	Initial values: U				Parameter type	$U_{min}$	$U_{max}$
	Solution 1	Solution 2	Solution 3	Solution 4			
Compressed air consumption, NI/cycle	0,9988	1,006	0,9983	1,2	Cost type	0,9983	1,2
Movement time forwards, s	0,12	0,18	0,16	0,15	Fixed type	0,15	0,15
Movement time backwards, s	0,465	0,3	0,7	0,9	Interval type	0,2	1
Pressing force forwards, N	260	280	250	290	Efficiency type	250	290
Pressing force backwards, N	55	97	90	60	Interval type	40	100

The algorithms give marks from 1 to 0 according to the suitability of the actuator characteristics to the previously established limits, where 1 is the maximum mark.

- Cost type case:

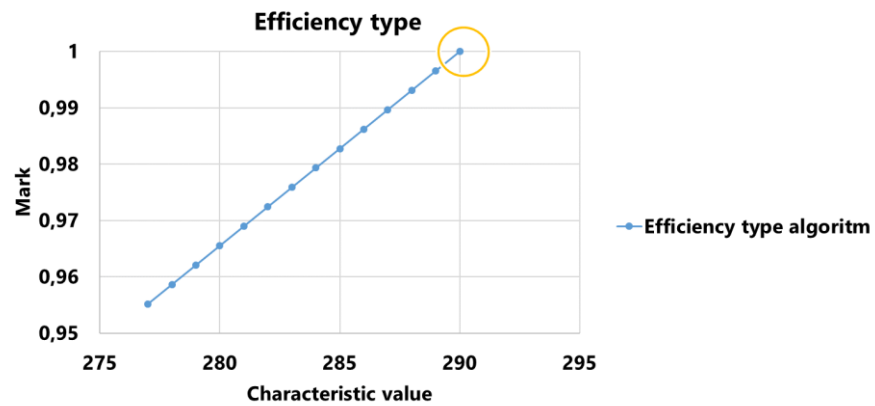
Assigns the maximum mark [1] (yellow circle) to the alternative with the lowest value of the characteristic. From this, assigns proportionally lower marks according to the difference of the value of the characteristic to the lowest value. The greater the distance to the ideal value, the lower the mark, the closer to zero.



**Figure 7:** Cost type by the original algorithm

- Efficiency type case:

This is the opposite case of cost type. Assigns the maximum mark [1] (yellow circle) to the alternative with the highest value of the characteristic. From this, it assigns proportionally lower marks according to the difference of the value of the characteristic to the highest value.



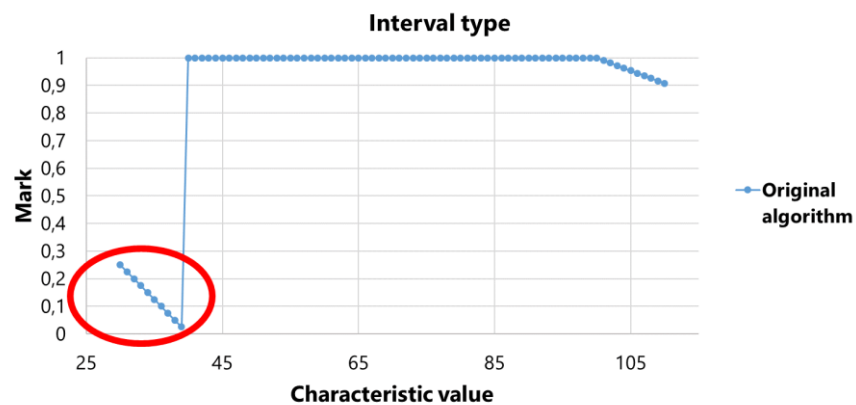
**Figure 8:** Efficiency type by the original algorithm

- Interval type case:

Assigns the maximum mark [1] to solutions whose characteristic value is within the valid interval, regardless of the distance at which the value lies within the interval limits.

For values outside the interval it assigns proportionally lower marks according to the distance from the interval limits.

The initial algorithm tests have shown that the algorithm is defective, because it gives very low marks to the values near the lower limit of the interval (red circle), even though they are at the same absolute distance as the values in the upper part.



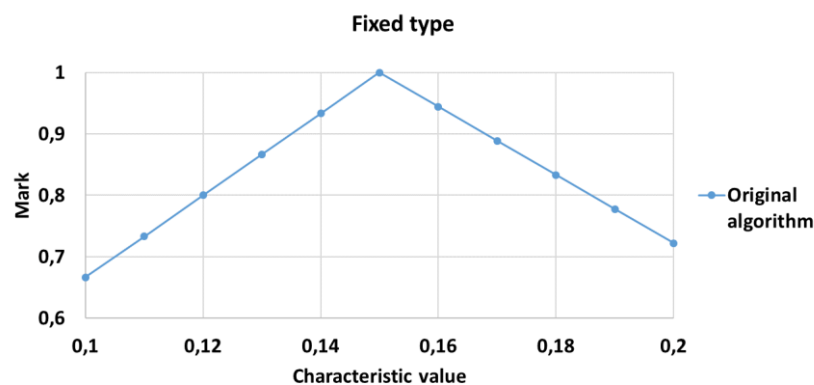
**Figure 9:** Interval type by the original algorithm



- Fixed type case:

It is rarely possible to find a fixed type variable, as most of them vary in an admissible interval and are not marked in a single value. This type of variables are like the interval type but with only one value within the interval, so only the values that coincide exactly with the fixed value will receive the maximum score [1], the others on both sides will receive proportionally lower values.

It is observed that the values given are not the same on both sides of the interval, so the values at the lower part of the interval are penalized.



**Figure 10:** Fixed type by the original algorithm

As explained above, in order to correct the mathematical errors that the formulas contain the MPE algorithms are analysed.

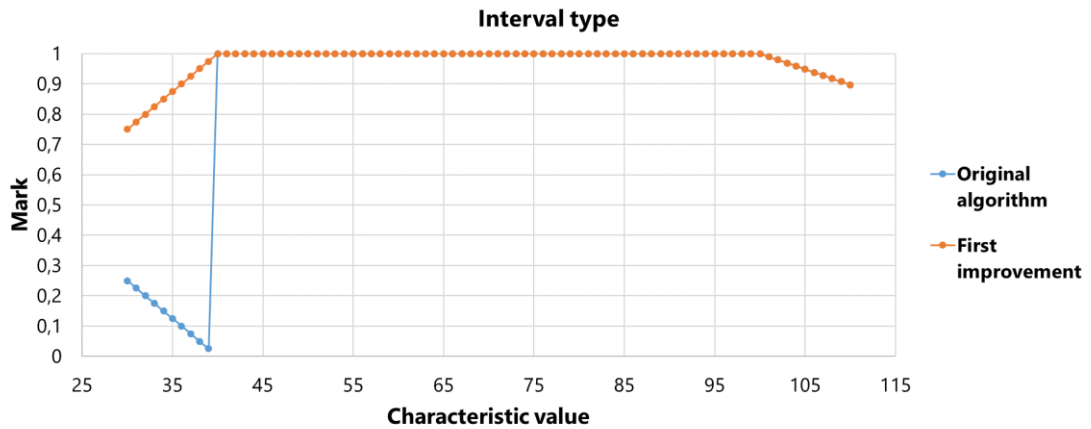
The algorithms of the interval type and cost type are redefined in order to achieve a symmetry in the assignment of notes.

- Improvement for the case of interval type:

The error in the lower limit of the algorithm is solved by changing the formula for the lower values, deleting the operator 1-, the complementary value is obtained. The standardization formula is now read as follows:

$$\left[ \begin{array}{ll} r_i = \frac{U_i}{c_1}, & U_i \in [U_{min}, c_1) \\ r_i = 1, & U_i \in [c_1, c_2] \\ r_i = 1 - \frac{c_2}{U_{max}} - \frac{U_i}{U_{max}}, & U_i \in (c_2, U_{max}] \end{array} \right.$$

After this first modification it is observed that the lowest values outside the interval are penalized (orange graph), giving them a lower grade despite being at the same absolute distance as the values of the upper part.

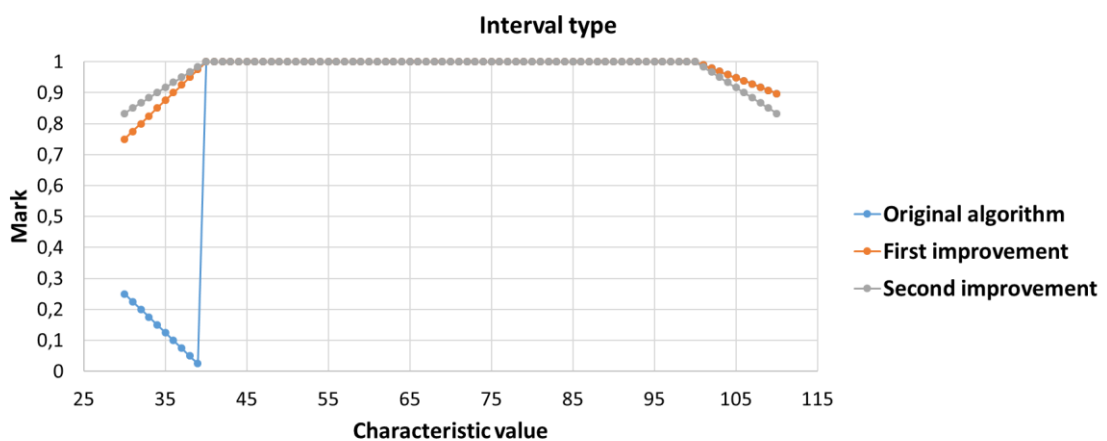


**Figure 11:** Interval type by the corrected algorithm

A new modification is made to correct this deviation and achieve marks symmetry. To do this, the standardization algorithm is changed completely, now pondering the differences in values over the amplitude of the interval, unifying the criteria for the values in the upper and lower part. The new standardization formula is now read as follows:

$$\left\{ \begin{array}{ll} r_i = 1 - \frac{c_1 - U_i}{c_2 - c_1}, & U_i \in [U_{min}, c_1] \\ r_i = 1, & U_i \in [c_1, c_2] \\ r_i = 1 - \frac{U_i - c_2}{c_2 - c_1}, & U_i \in (c_2, U_{max}] \end{array} \right.$$

The following graph shows the evolution of the improvements applied and finally the last model used (grey graph), where the given marks are symmetric.



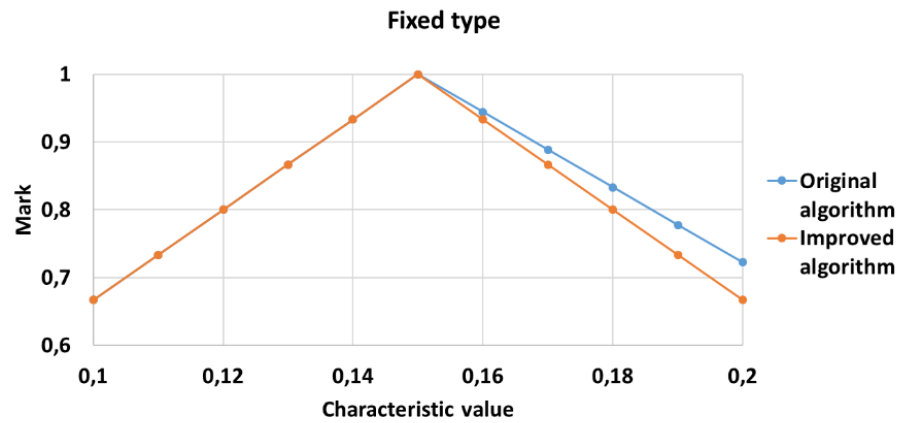
**Figure 12:** Interval type by the improved algorithm

- Improvement for the case of fixed type:

As in the previous case, the new algorithm equally ponders the values on both sides of the set value. The new standardization formula is now read as follows:

$$\left[ \begin{array}{ll} r_i = 1 - \frac{c_1 - U_i}{c_2 - c_1}, & U_i \in [U_{min}, c) \\ r_i = 1, & U_i = c \\ r_i = 1 - \frac{U_i - c_2}{c_2 - c_1}, & U_i \in (c, U_{max}] \end{array} \right.$$

The following graph shows the improvement applied (orange graph), where finally values in both sides are pondered in the same measure.



**Figure 13:** Fixed type by the improved algorithm

This results in a matrix of standardized elements:  $\mathbf{R} = (r_{ij})_{p \times n}$ ,  $i=1, 2, \dots, p$ ;  $j=1, 2, \dots, n$ ; where  $p$  is the number of samples and  $n$  is the number of attributes.

**Table 9:** Standardized values R

	Standardized values: <b>R</b>				
Characteristic	Solution 1	Solution 2	Solution 3	Solution 4	Sum of the attributes
Compressed air consumption, NI/cycle	0,999	0,992	1	0,831	3,823
Movement time forwards, s	0,8	0,8	0,933	1	3,533
Movement time backwards, s	1	1	1	1	4
Pressing force forwards, N	0,896	0,965	0,862	1	3,724
Pressing force backwards, N	1	1	1	1	4

The next step is the normalization of the matrix:  $\hat{\mathbf{R}} = (\hat{r}_{ij})_{p \times n}$ , where each element is calculated by the following formula, so that the sum of each attribute is equal to 1.

$$\hat{r}_{ij} = \frac{r_{ij}}{\sum_{i=1}^p r_{ij}}$$

**Table 10:** Normalized values  $\hat{\mathbf{R}}$ 

	Normalized matrix: $\hat{\mathbf{R}}$				
Characteristic	Solution 1	Solution 2	Solution 3	Solution 4	Sum of the attributes
Compressed air consumption, NI/cycle	0,2613	0,259	0,261	0,217	1
Movement time forwards, s	0,226	0,226	0,264	0,283	1
Movement time backwards, s	0,25	0,25	0,25	0,25	1
Pressing force forwards, N	0,24	0,259	0,231	0,268	1
Pressing force backwards, N	0,25	0,25	0,25	0,25	1

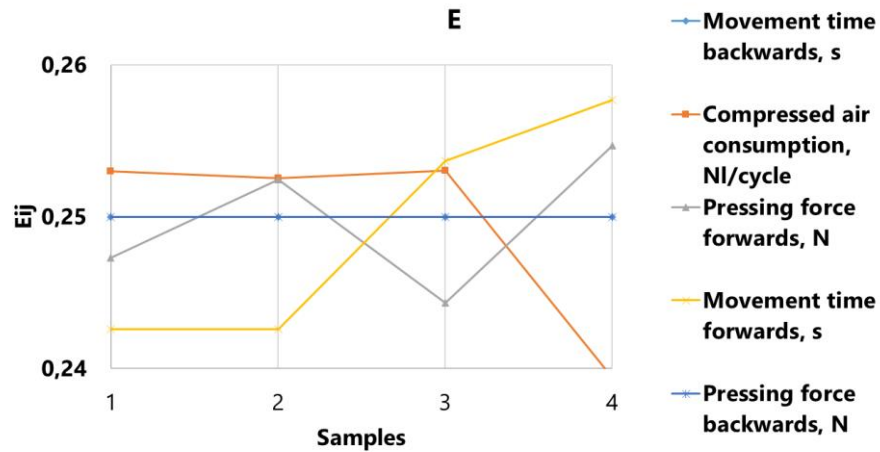
From the elements of the normalized matrix the vector information entropy vector attributes **E** is formed:

$$\mathbf{E} = [E_1, E_2, \dots, E_n]; E_j = \frac{1}{\ln p} \sum_{i=1}^p \dot{r}_{ij} \ln \dot{r}_{ij}; j=1, 2, \dots, n$$

**Table 11:** Information entropy vector attributes E

Characteristic	Solution 1	Solution 2	Solution 3	Solution 4	Information entropy vector attributes: <b>E</b>
Compressed air consumption, NI/cycle	0,252	0,252	0,253	0,239	0,997
Movement time forwards, s	0,242	0,242	0,253	0,257	0,996
Movement time backwards, s	0,25	0,25	0,25	0,25	1
Pressing force forwards, N	0,247	0,252	0,244	0,254	0,998
Pressing force backwards, N	0,25	0,25	0,25	0,25	1

The entropic information vector gives higher marks of the entropy to characteristics with less dispersed values. This way, if all the alternatives comply with one characteristic (blue graph) all of them will be pondered with the same weight (in this case 4 alternatives: 25% each one), giving rise to constant values: zero dispersion. The formula rewards this stability with the maximum note [1]. However, for characteristics with great differences in their values (yellow graph), in which not all the alternatives comply or move too far from the ideal value, there will be a greater dispersion of data, and the formula penalizes it with smaller marks.



**Figure 14:** Values for E per alternatives

Then the entropy weight vector of attributes  $\omega$  can be calculated through the following formula:

$$\omega = [\omega_1, \omega_2, \dots, \omega_n]; \omega_j = \frac{1-E_j}{\sum_{i=1}^n (1-E_i)}; j=1, 2, \dots, n$$

**Table 12:** Values for  $\omega$  per characteristic

Characteristic	Entropy weight vector of attributes: $\omega\%$
Compressed air consumption, NI/cycle	30,84%
Movement time forwards, s	50,90%
Movement time backwards, s	0,00%
Pressing force forwards, N	18,26%
Pressing force backwards, N	0,00%
Sum	100%

The meaning of this vector is the importance that the algorithm gives to each characteristic.

It is observed that if a characteristic is fulfilled by all the alternatives at the same time (characteristics 3 and 5) then it is not interesting to ponder it. While the algorithm gives a greater weight to those characteristics in which there is more dispersion of values.

The great advantage is that the weight factor is calculated automatically therefore it allows the user to achieve more objectivity in his evaluations.

Finally, a vector  $S$  is obtained:

$$S = \sum_{j=1}^n \hat{r}_{ij} \cdot \omega_j$$

**Table 13:** Vector S

	Solution 1	Solution 2	Solution 3	Solution 4
MPE value vector of actuators: <b>S</b>	0,879	0,889	0,941	0,948

The alternative that best fulfils the mechanical requirements will be the one that obtains a higher S mark.

## 5 Research: Economical side

### 5.1 TCO Methods

In order to carry out the comparison between components as equitably as possible, a suitable TCO method must first be selected.

In this selection it is interesting to find within the methods comparison parameters or parameters on which to make improvements.

The analysed methods are:

- **Life cycle cost analysis based on users (LCCABOU).** It takes into account the investment and maintenance costs within a certain period. From this presents, the results are presented as the sum of costs generated to the user over time. But has no basis for comparison between two technologies or parameters on which to make improvements. /Zha14/
- **Product cost accounting.** It assigns direct and indirect costs to the manufacture of final products, thus determining the cost of each unit or batch of product. It is not interesting from the point of view of the choice of technology, as it does not differentiate costs by stages of the process. It is more useful from a marketing point of view for establishing sales prices and profit margins. /Bra09/
- **Hour rate accounting.** It allocates resource costs as operating labour costs thus determining the operating costs of a machine hour. It is interesting to compare two technologies. It is also the best method to quantify inactive machine times. /Wolt11/
- **Activity-based costing (ABC).** It assigns the resources and the cost objects to the activities where they are invested. It is interesting for the comparison as it can easily compare tasks which implies direct labour, and also helps planification. /MC99/



The following table presents a summary of the four possible methods analysed:

**Table 14:** Costing methods

<b>Method</b>	<b>LCCABOU</b>	<b>Product Cost Accounting</b>	<b>Hour Rate Accounting</b>	<b>Activity-Based Costing (ABC)</b>
<b>Definition</b>	Results are presented as a sum of the cost due to the work of a machine	Determine the cost of the final product	Determine the cost of a machine hour	Measures the cost of activities, reflecting on them the resources and cost objects it uses
<b>Pros</b>	It takes into account the investment and maintenance costs within a certain period	It is possible to know the cost of the final product. Useful for market strategies as price settings	All costs incurred are taken into account reflecting them as hours of operating time (in hours) of the machine	<ul style="list-style-type: none"> <li>- Helps to optimize production flows</li> <li>- Provide a precise disaggregation of indirect costs</li> </ul>
<b>Cons</b>	Data cannot be used for optimization as it does not differentiate cost elements or processes	Does not provide a view from the point of view of the process, so cannot be used to compare technologies	Data cannot be used for activity planning	<ul style="list-style-type: none"> <li>- Does not quantify inactive times cost</li> <li>- Does not compare technologies as they have different activities</li> </ul>
<b>Conclusion</b>	There is no related parameter suitable for the comparison of two technologies	The production is unknown, this method can't be chosen	As it gets the cost per cycle and the working conditions are known its suitable for the comparison of pneumatic and electromechanical drives	Interesting for quantifying activities which implies material and human resources

### **Justification of the chosen method for the analysis**

As one a conclusion from the table the LCCABOU and the Product Cost Accounting are not suitable for our study, as they are not useful for comparing both technologies. This way, the chosen method will be a combination of two of them: Hour Rate Accounting and Activity Based Counting.

- Hour Rate Accounting. For the operational costs it is useful to know the cost of the machine per hour. As it is also convenient using the cost per hour to determine the cost of the inactive times.
- Activity Based Counting. For activities which implies human and material resources such as maintenance or commissioning, it is more interesting know the cost per activity to determine the distribution of the resources needed.

### **Hour rate accounting method**

Distributes the costs that are directly due to the operation with the machine (energy, raw materials, labour) between the hours that the machine is active, to obtain an operating cost per hour. It is interesting for comparing two technologies. It is also the best method to quantify inactive machine times.

### **Activity Based Counting method**

Activity Based Counting method will be used following the procedures of the article /MC99/. As it is defined in the article, the ABC method is based on the consumption of resources required by each activity involved in the production of a product. First, all the resources needed to perform each activity are defined, and secondly they are quantified. Resulting in the cost to the company for each time the activity is performed and providing information for better planning of activities and distribution of available resources.

3 concepts are taken into account in the ABC methodology:

- Direct labour
- Machine cost
- Raw material

By using this method, a process improvement could be done through learning, as activities can be planned in advanced and the resources can be focus where they are really needed.

The application of these two methods will be tested on a specific example comparing a pneumatic and a electric standard drive. The cost components assigned to each method will be explained in the example.

## 5.2 Installation definition

The conditions of the installation for which the actuators will be dimensioned, the operating conditions and other parameters that will influence the production are defined since these data will be necessary for the following calculations.

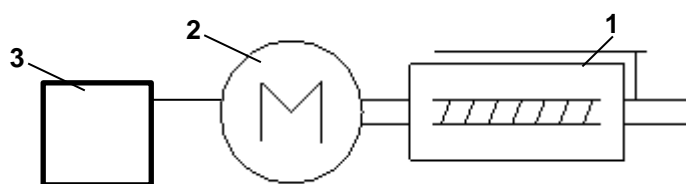
### Installation work conditions for the operating costs

The starting point is the operating conditions of the installation. these data need to be known in advance in order to dimension the system.

As a reference, conditions of operation for the automobile industry according to FESTO are established.

**Table 15:** Work conditions

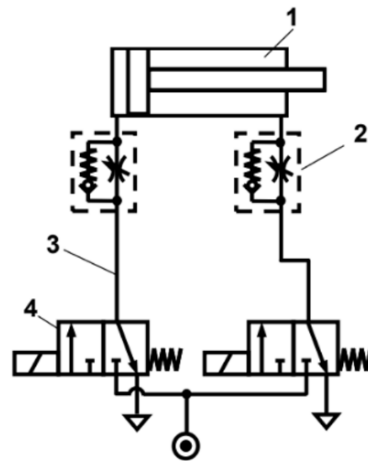
Parameter	Units
Drives in the installation	Number of units
Cycle frequency	s/cycle
Cycles per hour	cycles/hour
Cost of the compressed air	€/Nm <sup>3</sup>
Electricity prices for non-household consumers in the EU	kWh
Worker salary	€/h
Production per hour	products/hour
Benefit per product	€/product
Rent per month per m <sup>2</sup> for a industry	€/(month*m <sup>2</sup> )



**Figure 15:** Electromechanical drive

**Table 16:** Component overview of electromechanical drive

#	Drive Component	Type
1	Mini slide	EGSC-BS-KF-25-25-6P
2	Stepper motor	EMMS-ST-28-L-S
3	Motor controller	CMMO-ST-C5-1-DION



**Figure 16:** Pneumatic drive with meter-out control

**Table 17:** Component overview of pneumatical drive

#	Drive Component	Type
1	Cylinder	ADN-12-30-I-P-A
2	One-way flow control valve	GRLA-M5-QS-4-D
3	Hose	PUN-4X0,75-BL
4	Directional control valve	MHE3-M1H-3/2G-QS-6

### 5.3 Economic cost analysis

For the economic analysis, the following concepts have been taken into consideration. They are presented in the chronological order in which the user will find them.

Calculations are made of the annual cost for one actuator. The criterion of distribution of the common expenses will be equitable between the number of drives of the installation, since it is considered that all carry out the same use of the common installations.

**Acquisition costs.** Cost to formalize the purchase of the asset and its start-up. The initial investment is higher in the electromechanical drives.

**Purchase cost.** Price of the equipment is obtained from the data provided by the manufacturer. Includes the cost of all components per drive and the cost of auxiliary installations.

**Depreciation.** As explained in section 2, cost components, the depreciation method chosen is the linear one as indicated in the report of the consultant /EY16/ according to the German legislation.

$$\text{Depreciation} = \frac{\text{Acquisition cost} - \text{Residual cost}}{\text{Useful life}}$$

\*The residual cost will be settled as 0% of the acquisition costs. The asset is not intended for any other purpose and is not resold after use.

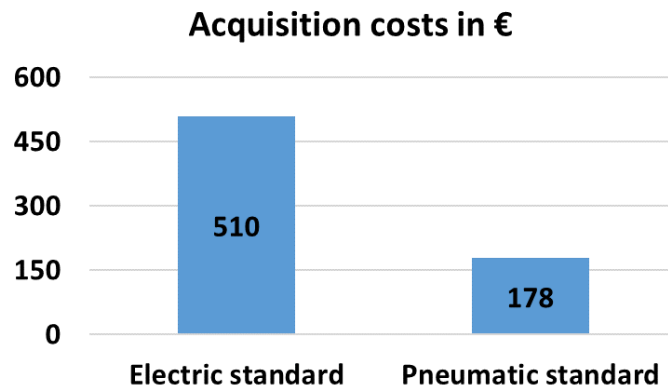
- **Commissioning costs.** Installation and testing costs are calculated as work hours. Commissioning costs are higher for electromechanical equipments, as they require more qualified teams. ABC method: resources are allocated to the activity, in this case only the working hours of the workers are considered. And from the hourly salary of a worker the cost of the activity is calculated.

$$\text{Commissioning costs} = \text{Salary per hour} \cdot \text{Number of hours}$$

- **Shipping costs.** Cost of the shipment of goods calculated with the data of the shipping company according to the dimensions of the components.

$$\text{Shipping costs} = \text{Shipping cost pro component} \cdot \text{Number of components in the instalation}$$

\*The reference shipping values taken are those provided by DHL for national shipments within Germany.



**Figure 17:** Acquisition cost in € per drive

**Operating costs.** Costs of running the machine and all the resources allocated to its operation. The hourly operating cost of a machine will be determined by the resources it consumes: compressed air and electricity.

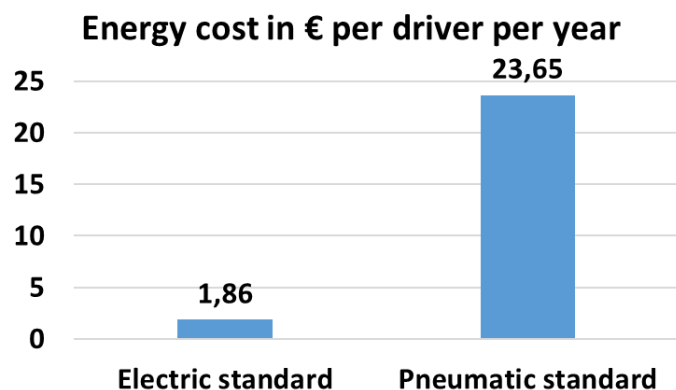
- **Energy costs.** Energy costs of electric actuators are lower, as they are basically due to motor power draw. The low voltage of the control systems have an insignificant consume that is not taken in the costs. However, the operating costs of pneumatic actuators are often higher due to low energy utilisation: low efficiency. The cost of compressed air for supply in the operating conditions of the machine already include the power of the compressor in the cost of compressed air per  $\text{Nm}^3$ .

#### Compressed air costs per hour

$$\text{Compressed air costs per hour} = \text{Cost of compressed air} \cdot \frac{1}{\text{Cycle frequency}} \cdot \frac{3600 \text{ s}}{h} \cdot \frac{NL}{1000 \text{ Nm}^3}$$

#### Energy costs per hour

$$\text{Energy costs per hour} = \text{Electricity price} \cdot \text{Energy consumption per cycle} \cdot \frac{1}{\text{Cycle frequency}}$$



**Figure 18:** Energy costs in € per drive per year

- **Maintenance costs.** Determined by the chosen strategy, they are the sum of the costs due to two subactivities: inactive times and repair activities.
- **Innactive time costs.** Which is important to reduce downtime that produce losses is to know the cost of each hour stopped, therefore the hour rate costing is used. Inactive time costs are calculated as non-production losses. Included as losses are the lost profit plus the fixed costs during the stop time.

$$\text{Inactive costs} = (\text{Benefit per product} + \text{Fix costs per hour}) \cdot \text{Production per hour} \cdot \text{Stop time}$$

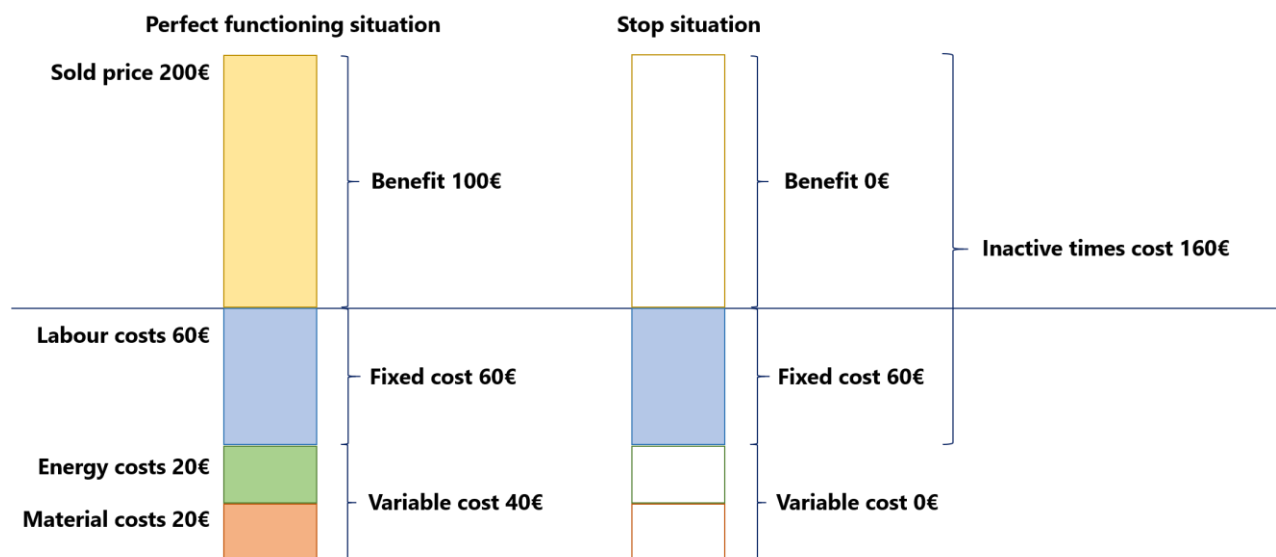
### Justification of the inactive time cost formula

Simplified fictitious data is used for the example.

A number of resources which suppose a cost (labour, energy and material) are used in order to obtain a finished product and sell it at a sale price higher than the sum of the costs obtaining a profit.

In the event of an unplanned stop that leads to a break in production, the company will have to continue to cover those costs that do not depend on production and that are kept constants.

In this example the labour costs are the only fixed component. The variable elements: energy and material are not consumed, so they are not considered a cost.



**Figure 19:** Costs in perfect functioning situation and in stop situation

The perfect functioning situation is that in which resources are consumed in their totality and a benefit is achieved. An stop situation is one in which programmed resources are consumed without achieving a product and therefore no benefit.

The difference between these two situations is taken as the cost of inactive time. In the example:

- Perfect functioning situation:

$$\text{Sold price (200€)} - \text{Fixed costs (60€)} - \text{Variable costs (40€)} = \text{Benefit (+100€)}$$

- Stop situation:

$$\text{Sold price (0€)} - \text{Fixed costs (60€)} - \text{Variable costs (0€)} = \text{Losses (-60€)}$$

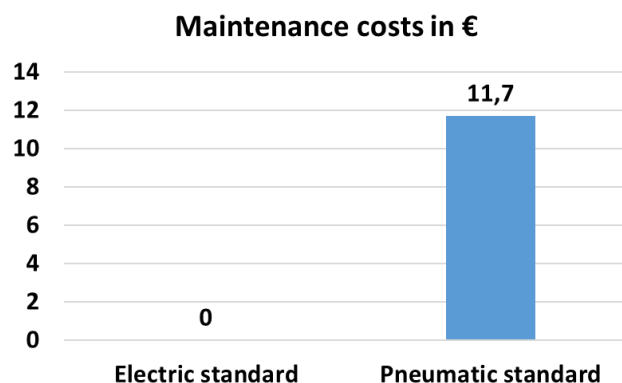
It is taken as inactive time cost the difference between these two situations since it is considered that the resources are invested in order to achieve a finished product, and therefore a benefit. If this benefit is not achieved because of an unplanned stop the company is paying its fixed costs that can not cancel, but is also renouncing the benefit for which it had started the machinery.

- Inactive time cost:

$$\text{Perfect functioning situation} - \text{Stop situation} = 100€ - (-60€) = 160€$$

- **Repairing costs.** The costs of replacing a defective part, correspond to the acquisition costs. As they are activities that can be planned and require the direct allocation of resources, the ABC method is used where there is only material costs. The justification for the calculations is explained in the maintenance strategy section 5.4.

$$\text{Replacement costs} = \text{Acquisition cost}$$



**Figure 20:** Maintenance costs in € per drive per year

**Fixed costs.** Costs that are maintained over time independently of the quantity produced or the times that the machines are inactive.

- **Space costs.** Is calculated on the basis of the price per square metre of industrial floor. Physical space of the actuators and their corresponding auxiliary elements in the plant. Fixed cost over the entire useful life of the equipment.



$$\text{Space costs} = \text{Price per } m^2 \text{ in industrial} \cdot m^2 \text{ occupied per component}$$

- **Storage costs.** Space occupied by safety stock in storage. It will be considered in this example that a safety stock will not be necessary due to the high reliability of the actuators.

**End of Life costs.** These are costs that only occur at the end of the life cycle of the equipment or have an impact on other activities, so it is not interesting to calculate an hourly cost.

- **Dismounting costs.** Equipment removal costs are calculated taking into account the time and resources required for removal. Since it is a programmable activity that is only carried out once throughout the life cycle, the ABC method is used. Fixed cost that occurs only once at the end of the life cycle. ABC method, some resources are allocated to the activity: again, as in the case of the commissioning, the working hours of the workers are considered.

$$\text{Dismounting costs} = \text{Salary per hour} \cdot \text{Number of hours}$$

- **Disposal costs.** The removal costs are a fixed cost depending on the nature and weight of the equipment to be removed. This data is provided by the waste management company. Fixed cost that occurs only once at the end of the life cycle.

$$\text{Disposal costs} = \text{Weigh of componenets} \cdot \text{Price per kg of waste}$$

### Rate of interest.

- **Rate of interest of bank loans.** The proportion of a borrowed amount that the bank charges to the borrower as an extra cost expressed as an annual percentage rate over the amount borrowed.
- **Rate of interest of own funds.** Percentage offered to the investor for investing his money in a project rather than in other funds, so he should be guaranteed a higher return.

**Table 18:** Origin of funds and combined rate of interest

	Rate of interest	Percentage of funds	Combined rate of interest
Own funds	4,00%	75%	5,25%
Bank loans	9,00%	25%	

$$\text{Amount of interest} = \text{Annual investment} \cdot \text{Combined rate of interest}$$

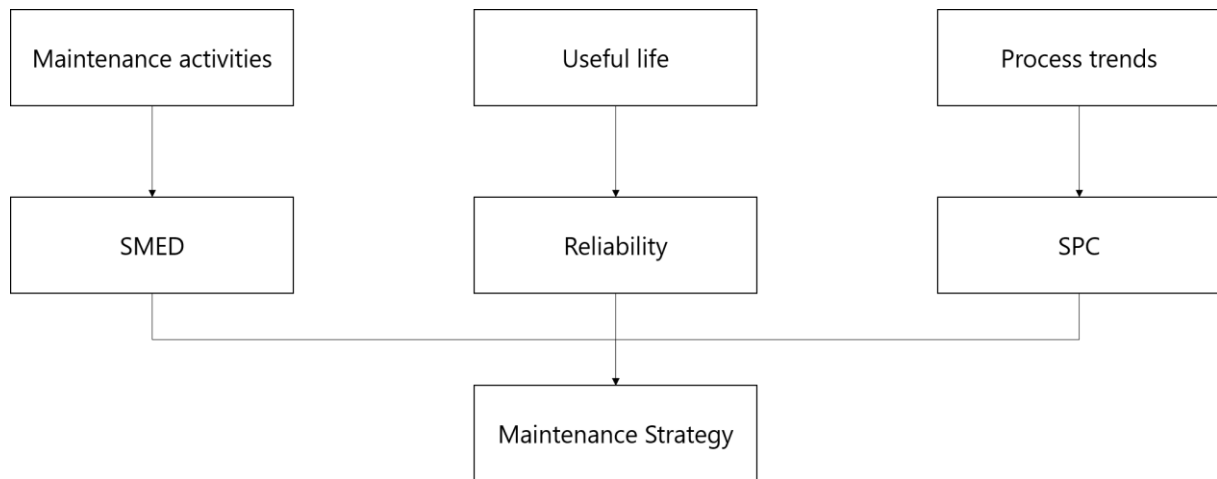
\*The annual investment is the sum of the equipment costs at the end of each year after applying the corresponding depreciation and the operating costs.

## 5.4 Maintenance strategy

For the analysis of this section the strategies of the article /Herr11/ are used.

Maintenance costs are dynamic, which means they depend on the usage pattern and failure behaviour. It is possible to reduce costs by selecting the most optimal maintenance strategy.

For the determination of the maintenance strategy, three concepts must be considered: maintenance activities, useful life and process trends.



**Figure 21:** Scheme of selection of the maintenance strategy

**Maintenance activities.** It is necessary to identify the sequence of the relevant maintenance activities.

The time that a machine is inactive includes not only the time of the change and physical adjustments of the machinery, but also implies all the time that the machine is not being productive: from the manufacture of the last valid piece to the obtaining of the first completely correct piece. This technique is chosen as one of the pillars of LEAN Manufacturing philosophy originating in Japan, within Toyota in the 50's and taken as a reference for process optimization in modern industry nowadays. For this purpose, **SMED** (Single-Minute Exchange of Die) technology is used to reduce machine set-up times to a minimum.

The implementation of the Single Minute Exchange of Die system allows to reduce the preparation time of the machine to manufacture small batches and eliminate stocks.

There are two types of maintenance activities:

- External activities: those that it is possible to do with the machine running e.g. cleaning and tidying of the workplace or verification of the raw material.

- Internal activities: those that can be done only with the machine stopped, which cause inactive machine times and they are damaging as they are very expensive e.g. calibration or lubrication of internal components.

The main objective is to externalize as many maintenance activities as possible and remove repetitive or non-value adding tasks, as it aims to reduce machine inactive time.

A detailed chronological listing of operations during inactive machine time is made. Each internal operation is studied to determine if any part of it can be externalized to save time. Where it is not possible to perform with the machine stationary its objective is to minimize the setting time.

**Table 19:** External and internal activities for pneumatical drives

External activities	Internal activities
Maintenance unit activities	
Check filter and manometer	
Drain condensation water	
System activities	
Check pressure tank, pressure reduction valve, warming devices	Check bolted joints and cylinder rod bearings
	Check connections, tube, hose joints for leakage

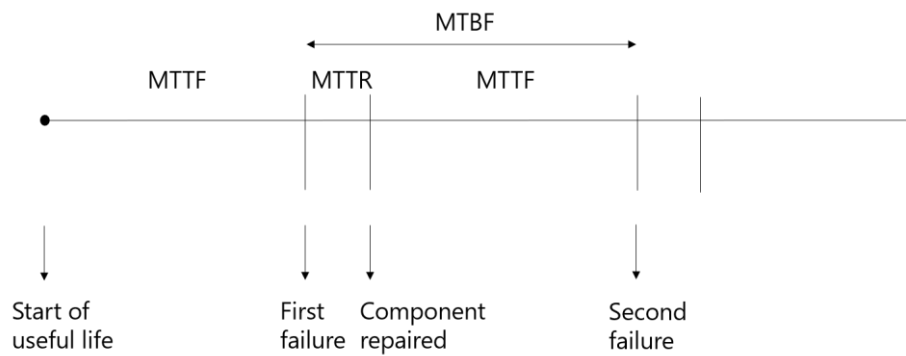
Based on experience, for electromechanics no maintenance activity is considered necessary. /Tho18/

**Useful life.** When choosing a strategy, the reliability of the components must be considered.

The **reliability** of a component is the probability that it will function correctly for a certain period of time under certain working conditions.

For quantifying reliability so it is possible to make estimates of the useful life of the component, some values are available: MTTF (Mean Time To Failure), MTTR (Mean Time To Repair) y MTBF (Mean Time Between Failures).

- MTTF (Mean Time To Failure). Average time a component is expected to be operational.
- MTTR (Mean Time To Repair). Time required to repair the component once the failure has occurred.
- MTBF (Mean Time Between Failures). The average time it will take for a component to fail after the previous failure. It is expressed as:  $MTBF = MTTR + MTTF$



**Figure 22:** MTTF, MTTR and MTBF over the life cycle

Depending on the application, the use of one or the other will be more interesting. In the case of actuators, it is important to know both parameters, the time to failure as well as the repair time, as both will have an impact on costs.

From these values the durability or quality of a component is evaluated for decision making. Also based on these times the maintenance will be planned and material acquisitions will be estimated.

This concept will not be used in the study of this article as it takes a very short usability period (5 years), as the technology becomes obsolete quickly and changes are required.

**Process trends.** By following the process conclusions can be reached and failures anticipated.

**SPC** (Statistical process control) is a statistical method of early detection that aims to reduce waste and prevent the spread of defects. The SPC takes data from the process at different points and instants to detect and correct trends in the process that may affect quality.

Its main advantage over other methods is that it acts before failures occur, within a range of accepted uncertainty and does not cause disruption in the process.

### **Selection of maintenance strategy**

From the collected data the selection of the best maintenance strategy is proceeded.

Maintenance strategies are divided into two main groups: programmed and unprogrammed. The programmed ones, also known as preventive, aim to avoid, anticipate or reduce the probabilities of failure. And unprogrammed or corrective ones, which are carried out only in case of component failure.

The objective of a good maintenance strategy is to minimize unprogrammed activities, which produce the highest costs.

The three main maintenance strategies presented are:

- RCM (Reliability Centred Maintenance)
- RBM (Risk Based Maintenance)
- TPM (Total Productive Maintenance)

**Table 20:** Maintenance strategies

Strategy	Preventive		Corrective
	RCM	RBM	TPM
Base	Time	Observations Trends	Failures
Activity	Service	Inspection	Reparation
Operations	- Cleaning - Lubrication - Adjustment	- Verification - Analysis	- Replacement - Repair - Recovery
Grade of repair	Minimum	Incomplete	Total
Periodicity	Established periods	According to trends	MTTF
Cost of activity	Minimum	Medium	Maximum

### Example of application of the maintenance strategies

An example is made by analysing three processes with each strategy. Sigmasigma is the greek letter used to represent the standard deviation, that gives an idea of the variability in a process. The sigma level is a measure of how good the processes are and is determined by reviewing how many standard deviations fit between the process specification limits and the target. The ideal situation is to reach a 6 sigma process or the perfect process, where the number of defects drops to 3,4 defects per million opportunities (dpmo). /Gue19/

**Table 21:** Quality level of a process according to its sigma level

Process	Sigma level	Defects	Meeting percentage	Industry
Perfect	6	<3,4 dpmo	99,999%	World-class
Medium	3-4	<66.807 dpmo	>93%	Industry average
Out of Control	1-2	>308.538 dpmo	<70%	Below industry average. Not competitive

A perfect process is stable and capable. Stable, as its consistent, predictable. And capable, as it fits customer requirements. It has no detectable trends, its statistically random inside the established limits.

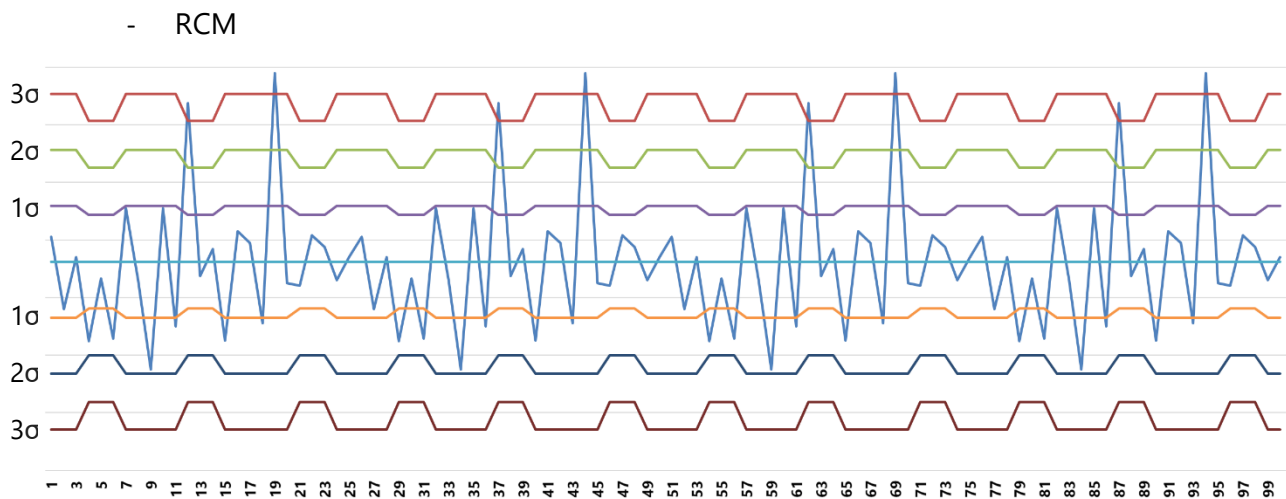
A medium process is stable with some outliers, which means there are some data in the sample that doesn't fit the specification control limits.

An out of control process it is unpredictable, it exceeds the limits of the process and does not guarantee any product quality. it is necessary to analyse the causes and search for permanent solutions.

It is used as a process to study the medium process (3 sigma) since it is considered a realistic situation that represents the industrial average, in which work is done to achieve a perfect process and in which it is necessary to take measurements but this has been achieved within control.

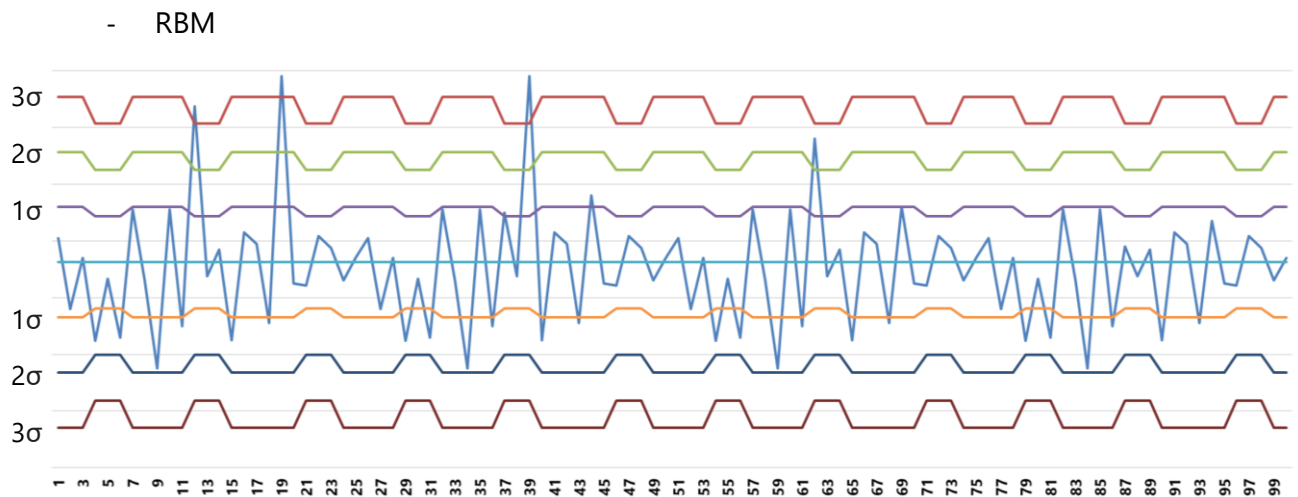
In each case, a first sample of 25 measurements is taken, and another three measurements of 25 samples are taken, taking the relevant measures according to the strategy to check the evolution of the process and the costs.

The blue graph corresponds to the measurements over time and represents some mechanical characteristic of a product taken as an example (e.g. specific dimension of a part). The limits are different by segments because it depends on the number of data of each sample taken. With more data more stringent limits can be set. They are control limits, not customer specifications.



**Figure 23:** Evolution of the process under RCM strategies

The preventive actions reduce some variability but still doesn't correct trends.

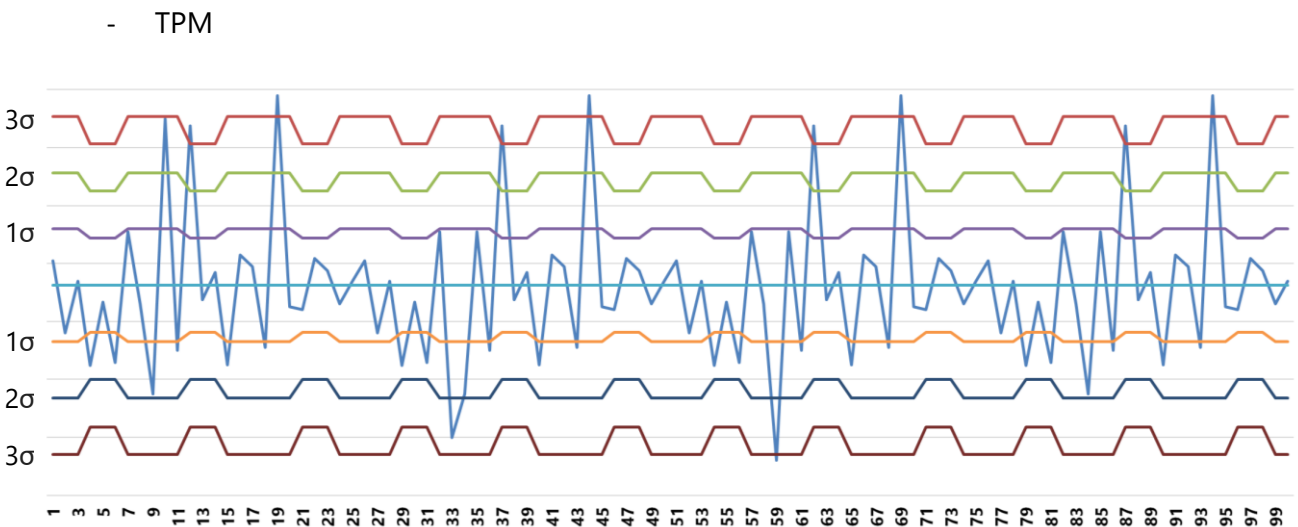


**Figure 24:** Evolution of the process under RBM strategies

The process reduces its variability by the SPC analysis, that means, by detecting trends in the process a patron can be detected and the preventive actions can be taken before the process reach the limits out of the client’s requirements.

Repeating this process over time the variability is reduced until 6 sigma, guarantees 99,9% of products are inside the standard.

This way, the repairing costs are reduced to zero, and only the inspection costs must be sustained. The process turns to be capable: fit customer requirements, and stable: predictable.



**Figure 25:** Evolution of the process under TPM strategies

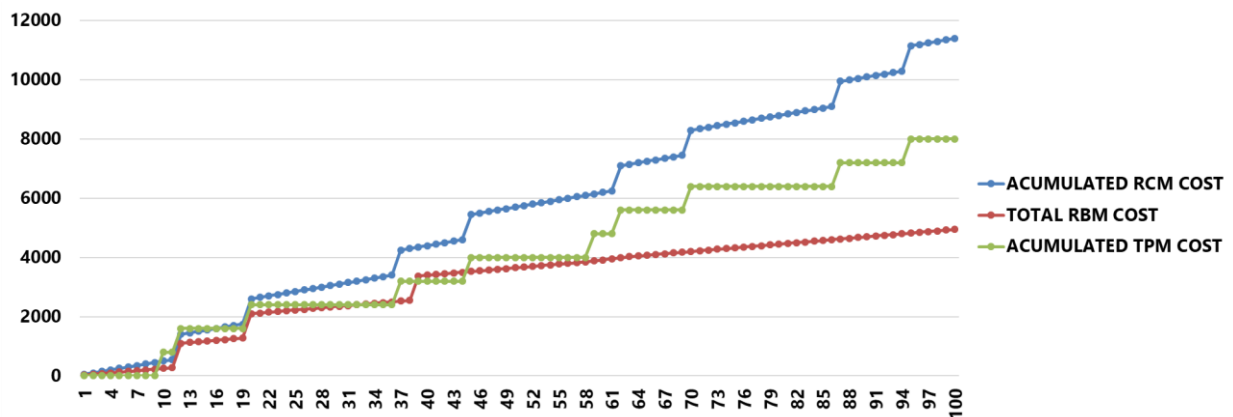
As there are no preventive but corrective actions taken, the process continue failing over time, repeating failure trends.

The costs of each strategy are calculated using the following formulas:

$$RCM \text{ costs} = \text{periodic activ} + \text{replacement costs}$$

$$RBM \text{ cost} = \text{periodic activ} + \text{replacement costs} + \text{measuring activ} + \text{preventiv activ}$$

$$TPM \text{ cost} = \text{replacement costs}$$



**Figure 26:** Accumulated cost per strategies for a medium process

As can be seen, RBM strategy establishes its costs over time as it reduces process variability, not requiring repairing cost after a few cycles of improvements.

With the TPM strategy there is no prevention activities, so there are no fixed costs, but there are also more outliers as there is no action taken, therefore the number of preventive actions is greater.

With the RCM the fixed costs for cleaning and lubrication persist over time but as there is no corrective actions the failures continuing happening.

As a conclusion: the RBM strategy is the cheapest and the one that offers the most guarantees when correcting the process within the limits.

### Conclusion of the selected maintenance strategy

The TPM method is discarded because it is exclusively corrective, since the analysis aims to reduce the uncertainty and large costs associated with the repair or replacement of the component, since it means in each action the cost of inactivity, the cost of labour and the cost of materials. In addition, without trying to avoid the cause of the failure in any case.

Therefore, it will be more efficient to focus on a preventive maintenance method.

Due to the reasonable average times until failure of the drives, a periodic maintenance is discarded, and it is opted for a monitoring of the process.



In this case the most appropriate strategy will be: RBM.

The advantages of this maintenance strategy are:

- Prevents failures.
- Reduction of inoperative time of the machine.
- Reduction of downtime spent on repairs.
- Extend the life of the equipment by having it in optimal conditions.
- Ensures quality by preventing product defects.
- Not invasive: for the taking of measures it is not necessary to stop the process.
- Optimization of resources: resources are focused on the parts of the process that are most dangerous or vulnerable, and the parts of the process whose operation is optimal are not intervened.

For all these reasons, the final result is a reduction in costs.

## 6 Combination of economical and technical sides to one method

After both analysis were developed it is possible to combine both aspects and concentrate all the information to provide the user with a compilation of results and facilitate decision making.

The steps for the combination of both sides are as follows:

- 1) Set installation conditions
- 2) The user must define required tasks for each drive
- 3) From the required tasks establish the relevant mechanical specifications (e.g. speed, force)
- 4) Selection of eligible drives for further analysis
- 5) Mechanical and economic analysis
- 6) Conclusion of the analysis: a representation in bidimensional graph of the results of all the alternatives is obtained. However, after obtaining the result it is helpful to filter the available alternatives by Pareto's efficiency criterion, which will be explained below, thus showing clearer results to the user.
- 7) User selection. The final choice will depend on all cases of the user, who will mark according to their own limitations and maximum budget, which is usually the most usual limitation.

The Pareto efficiency criterion explains that a point is a Pareto optimum if there is no other point that has better values obtained in any of the criteria. The solution to the multi-objective optimization problem will not be unique: the solution will be formed by the set of all the points known as the Pareto frontier.

To do this, the algorithm compares alternatives 2 to 2 and eliminates those that are surpassed in both criteria by at least one other alternative. It makes no sense to continue considering an option that is inferior in all the criteria at the same time as opposed to another, as it will never be chosen.

This gives rise to a Pareto border on which always will be found:

- As first point the most economical option, as no alternative can surpass in all criteria to the lowest cost.
- As last point the option with better mechanical properties, no alternative can surpass at the same time in all the criteria to the one that has the maximum mark according to the algorithm.
- In the middle a series of points form the Pareto boundary, which will contain the points which are in a balance between economic and mechanical terms and which are not

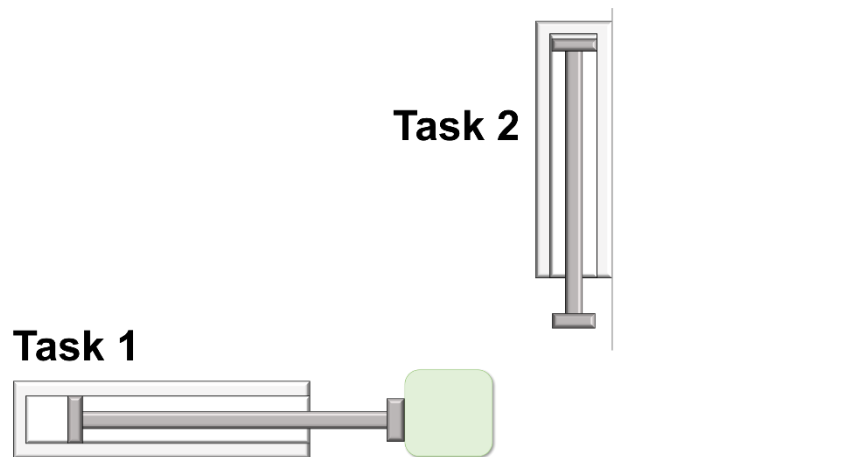
surpassed by any other. The shape of the border (more vertical or more horizontal, concave or convex) will depend on the relationship between the most economic point and the one with the best mechanical properties.

For the presentation of results a two dimensional graph with axes is used: Mechanical properties and Price per drive per year.

### Practical case

For the validation of the method a practical case is made in which the suitability of several pneumatic and electromechanical actuators for a given task is compared.

In the example below the goal is to select the best alternative for two tasks, task 1: movement task and task 2: force task.



**Figure 27:** Drives layout

First, the operation conditions that the piston has to fulfil for each task are defined. In this case the conditions are the same for both tasks.

**Table 22:** Given operation conditions for the practical case

Operation conditions for task 1 and task 2	
Cycles per hour	2.000
Cycles per year	8.000.000
Useful life	5 years

Based on the functions to be performed by each drive, the user must choose the mechanical properties that will determine the choice of the solution.

**Table 23:** Mechanical properties to be analysed

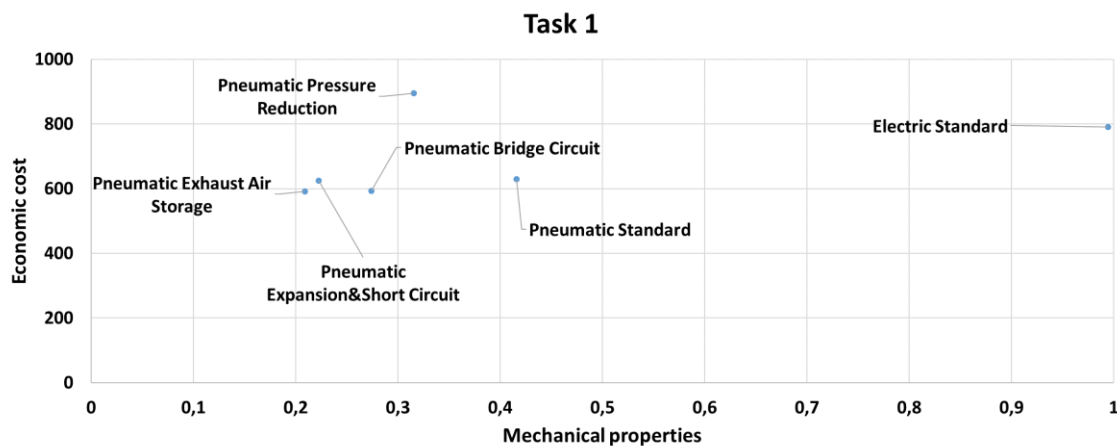
Task 1 – Movement task	Task 2 – Force task
Energy consumption per cycle, kWh/cycle	Energy consumption per cycle, kWh/cycle
Movement time forwards, s	Movement time forwards, s
Movement time backwards, s	Movement time backwards, s
-	Pressing force forwards, N

This leaves 6 possible alternatives for task 1: 5 pneumatic and 1 electric. And 5 alternatives for task 2: 4 pneumatic and 1 electric.

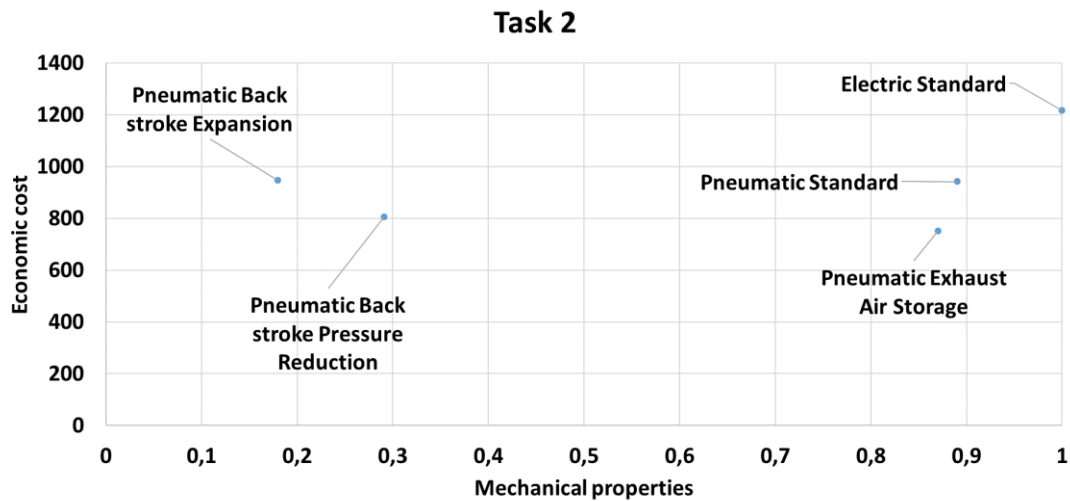
**Table 24:** Alternatives to be analyzed

Task 1 – Movement task		Task 2 – Force task	
<b>1.1</b>	Pneumatic Standard	<b>2.1</b>	Pneumatic Standard
<b>1.2</b>	Electric Standard	<b>2.2</b>	Electric Standard
<b>1.3</b>	Pneumatic Bridge Circuit	<b>2.3</b>	Pneumatic Back stroke Expansion
<b>1.4</b>	Pneumatic Exhaust Air Storage	<b>2.4</b>	Pneumatic Exhaust Air Storage
<b>1.5</b>	Pneumatic Pressure Reduction	<b>2.5</b>	Pneumatic Back stroke Pressure Reduction
<b>1.6</b>	Pneumatic Expansion&Short Circuit	-	-

After the economic and mechanical analysis, a first representation of results is obtained within all the alternatives for a period of 5 years.



**Figure 28:** Results of the alternatives after analysis for task 1



**Figure 29:** Results of the alternatives after analysis for task 2

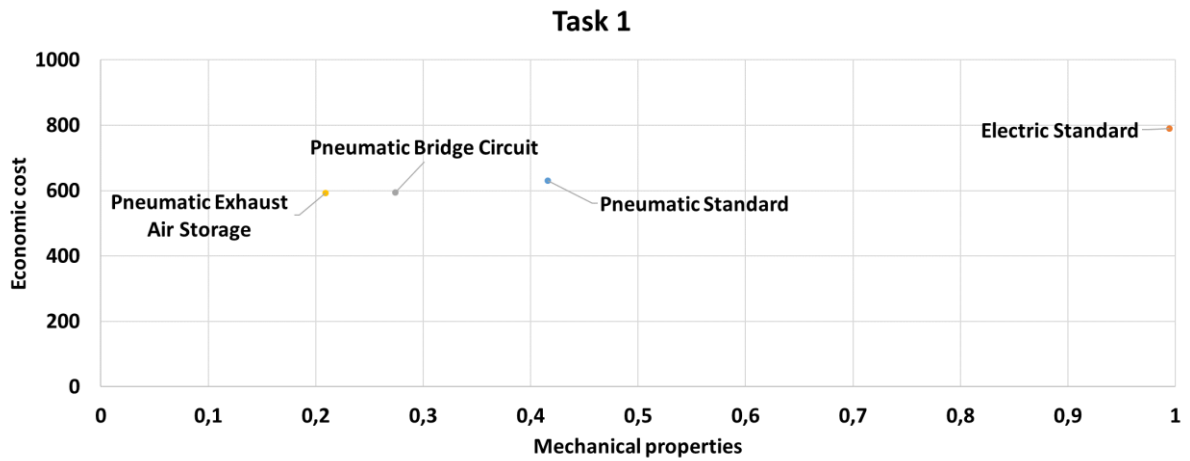
In order to carry out the filtering the alternatives are compared two by two. If an alternative has only one that exceeds it then it will be eliminated. In the following table, if an alternative has in its column a cell marked "INFERIOR", that alternative is surpassed by the alternative of that row.

**Table 25:** Comparison of alternatives by pairs

	Pneumatic Standard	Electric Standard	Pn. Bridge Circuit	Pn. Exhaust Air Storage	Pn. Pressure Reduction	Pn. Expansion & Short Circuit
Pneumatic Standard	/				INFERIOR	
Electric Standard		/				
Pn. Bridge Circuit			/			INFERIOR
Pn. Exhaust Air Storage				/		
Pn. Pressure Reduction					/	
Pn. Expansion & Short Circuit						/
	Keep alternative	Keep alternative	Keep alternative	Keep alternative	Delete alternative	Delete alternative

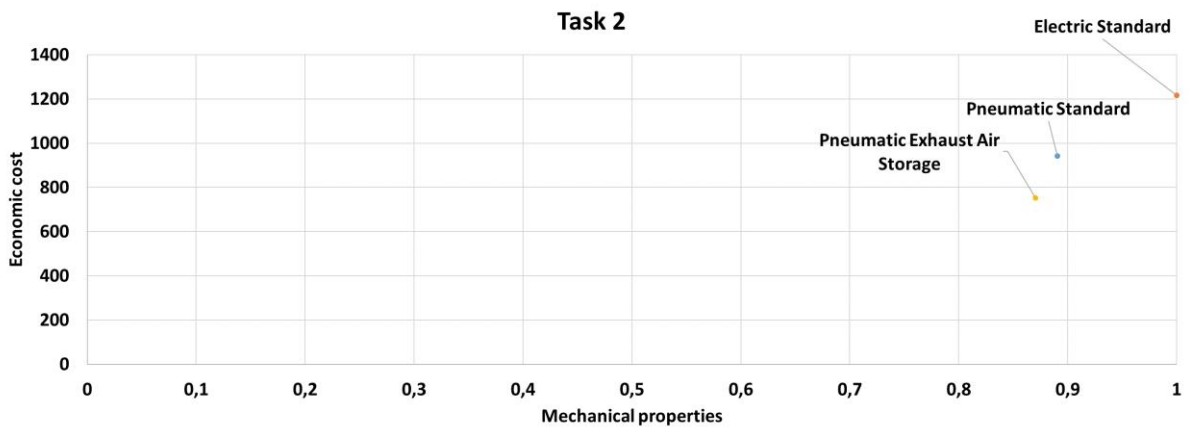
Alternative Pneumatic Pressure Reduction is inefficient compared to alternative Pneumatic Standard. The same applies to alternative Pneumatic Expansion & Short Circuit, which is inefficient compared to Pneumatic Bridge Circuit.

After the filtering of the Pareto efficiency criteria the alternatives are reduced to the Pareto curve options, offering the user the cheapest alternative, the most mechanically efficient alternative and those balanced in the middle.



**Figure 30:** Results of the alternatives left after Pareto analysis for task 1

The same procedure is followed for Task 2, resulting in the following result.



**Figure 31:** Results of the alternatives left after Pareto analysis for task 2

## 7 Conclusion and outlook

To make the study more complete it can be extended to the environmental field, which has gained importance in recent years due to regulations in this area within the context of important international agreements such as the Kyoto Protocol, of which Europe is one of the main drivers, reducing CO<sub>2</sub> emissions has become a political and public priority.

### Extended CO<sub>2</sub> consideration

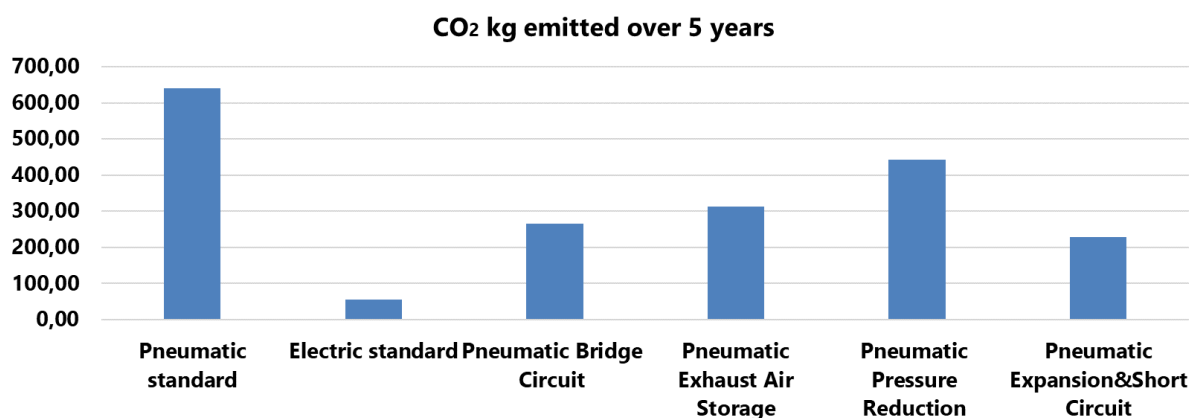
The Environmental impact is valued with the Emissions of kg of CO<sub>2</sub> as it is the main source of pollution and there are no other dangerous fluids due to industrial activity.

A calculation is made of the kg of CO<sub>2</sub> emitted due to the production and operation for 5 years with each technology.

For the calculation of the CO<sub>2</sub> emissions in the manufacture of the actuator components the table Emission factors in kg CO<sub>2</sub>-equivalent per unit is used /Win12/. By knowing the dimensions of the components and the density of the materials (mainly aluminium and polyurethane) the table provides for each construction material the kg of CO<sub>2</sub> emitted per kg of material (8,14 kg CO<sub>2</sub>/kg aluminium and 5 kg CO<sub>2</sub>/kg polyurethane).

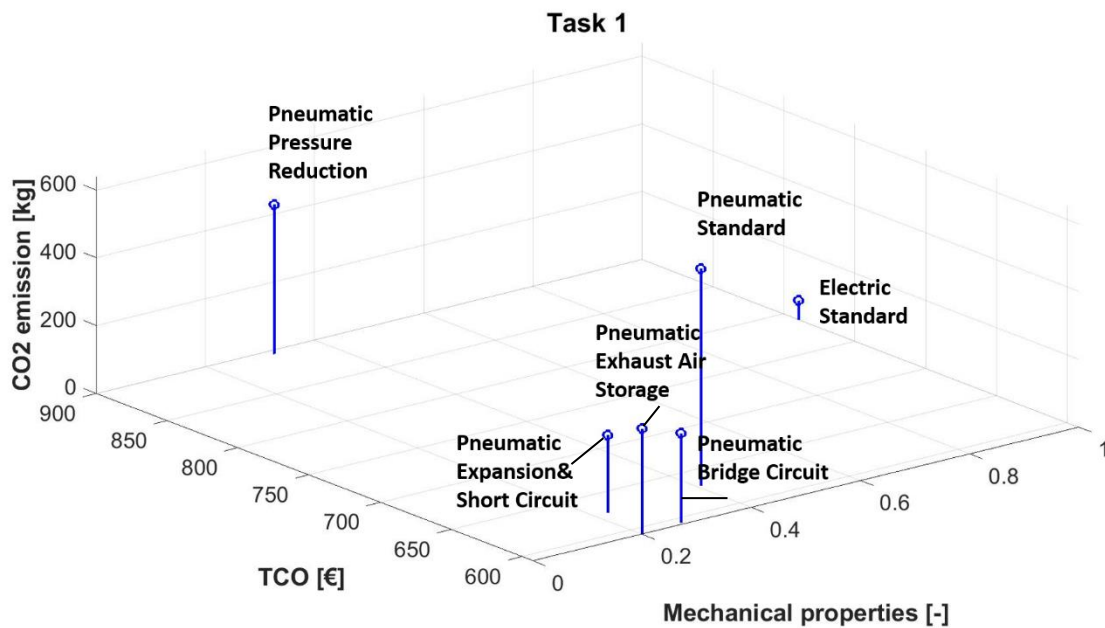
The kg of CO<sub>2</sub> emitted in the operation are directly related to the energy in kWh consumed per cycle, being 0,622 kg CO<sub>2</sub> emitted/kWh. /Min/

This way, although the manufacture of the electric one more kg of CO<sub>2</sub> are emitted; in the operation due to its low energy consumption this difference is more than compensated, resulting in a much cleaner technology.

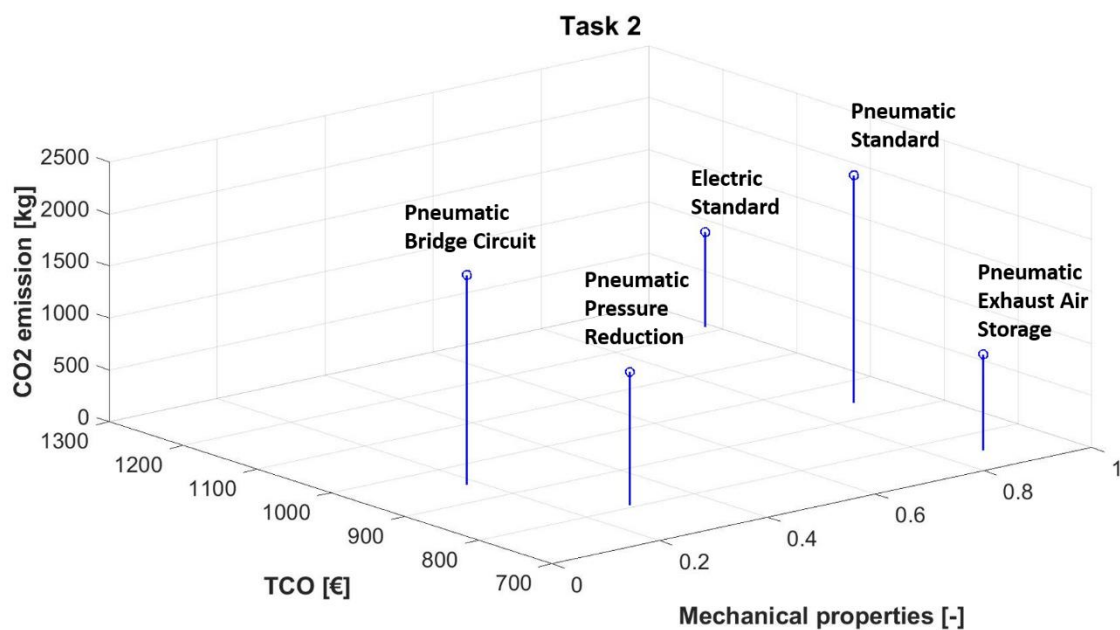


**Figure 32:** kg CO<sub>2</sub> emitted over 5 years for the selection of alternatives for task 1

A combination of the three aspects is made offering the user a 3D graph where he can easily compare the marks of each alternative in each category at a glance.



**Figure 33:** 3D graphic with the alternatives represented in each field for task 1



**Figure 34:** 3D graphic with the alternatives represented in each field for task 2

Efficiency improvements in pneumatical drives will reduce energy consumption and therefore CO<sub>2</sub> emissions.

### Main conclusions

In the mechanical field, an algorithm for assessing the suitability of the actuators for a particular task that the user does not influence was chosen and validated. The errors found in the MPE algorithm of the article /Zha14/ were corrected.



---

From an economic point of view this analysis is more complete and the ones analyzed until now because it calculates with greater precision the components of the costs, for example the components of the shipment or the commissioning costs, beyond only the acquisition and operation costs.

Also the choice of one maintenance strategy or another affects directly the cost throughout the life cycle, so a maintenance strategy appropriate to the type of process is selected.

A new method is introduced for cost accounting: ABC and a combination of methods is used to account the costs based on the utility of each variable, as is not done in other previous articles.

Improvements from the LEAN methodology such as SMED and SPC are proposed, and the concept of reliability is also included. It is essential to take this concept into account, since the extra time used due to excessive failures produced by a low reliability device will directly impact as costs of: inactive times, raw materials or specialized labor.

The complete installation is also taken into account when calculating the costs, including all factors which have an indirect impact as costs to be distributed between the elements of the installation. This way, a better dimensioning of the installation is achieved, which will work in a safer and more profitable way.

After the analysis a filtering with the Pareto efficiency criterion is also carried out for a clear, concise and quick presentation of results to the user.

And in the environmental field, under the same working conditions and with similar mechanical properties of pneumatic and electric actuators, the emissions of electric actuators are much lower than those of pneumatic actuators, resulting in a much more eco-friendly alternative.

As disadvantages of the method the environmental study is confined to CO<sub>2</sub> emissions during manufacturing and operation, it is a simplification, but other phases of the life cycle are not being considered. As the article /Zha14/ explains, it is very expensive and complex to carry out measurements.

The study could also be extended to more methods of mechanical evaluation, since in this analysis two articles have been studied but simpler methods could be found.

## 8 Literature

- /Ath09/ A decision support system for coating selection based on fuzzy logic and multi-criteria decision making. G. Athanasopoulou, C. Riba Romeva, C. Athanasopoulou. 2009
- /Ba95/ Life Cycle Cost Tutorial. H. Paul Barringer, P.E., Barringer & Associates, Inc., P. O. Box 3985, Humble, TX, Phone: 713-852-6810, FAX: 713-852-3749 and David P. Weber, D. Weber Systems, Inc. 1018 Seapine Ct., Maineville, OH 45039
- /Bra09/ Steven M. Bragg. Cost Accounting Fundamentals. 2009
- /Cr92/ Robert Creese, M. Adithan. Estimating and Costing for the Metal Manufacturing Industries. 1992
- /EnE12/ EnEffAH – “Energy Efficiency in Production in the Drive and Handling Technology Field”. 2012
- /EY16/ EY. Worldwide Capital and Fixed Assets Guide 2016
- /Festo/ Manufacturer Festo: [https://www.festo.com/us/en/c/automation/industrial-automation/actuators/pneumatic-actuators/rotary-actuators-id\\_pim217/](https://www.festo.com/us/en/c/automation/industrial-automation/actuators/pneumatic-actuators/rotary-actuators-id_pim217/) (requested on: 18.09.19)
- /Festo17/ Manufacturer Festo: Semi-rotary drives DSR/DSRL <https://www.festo.com/media/pim/160/D15000100122160.PDF> (requested on: 18.09.19)
- /Gon18/ Engineering Refresher: The Basics and Benefits of Electromechanical Actuators. C. Gonzalez. 2018
- /Gue19/ V. Guerrero. What is six sigma? February 2019
- /Herr11/ Dynamic life cycle costing based on lifetime prediction of C. Herrmann, S. Kara & S. Thiede. 2011
- /Mall99/ Costes. F. J. R. Mallada 1999
- /MC99/ Activity-based costing for production learning by the authors: M.C.Andradea, R.C.Pessanha Filhoa, A.M.Espozelb, L.O.A.Maiab and R.Y.Qassimb. 1999
- /Mer17/ Pneumatische und elektro-mechanische linearantriebe – Ein vergleich der TCO. S. Merkelbach. 2017
- /Min/ Ministry of Energy and Mines of Peru: [http://www.minem.gob.pe/giee/pdf/GUIA\\_SECUNDARIA\\_CAP6.pdf](http://www.minem.gob.pe/giee/pdf/GUIA_SECUNDARIA_CAP6.pdf) (requested on: 20.09.19)
- /Per17/ Sports Management as an Emerging Economic Activity: Trends and Best Practices. M. Peris-Ortiz, J. Álvarez-García, M. Del Río-Rama. 2017

- 
- /RIB02/ C. Riba Romeva. Concurrent design. 2002
- /Tho18/ The Maintenance Engineer's Guide to Industrial Actuators Comparing electromechanical, hydraulic and pneumatic actuators Travis Gilmer, Thomson Industries. M. Miller, Motion Industries. 2018
- /Twin19/ Total Cost of Ownership (TCO) REVIEWED BY A. TWIN. 2019
- /VDI98/ German Engineering Association: *Design engineering methodics: Engineering design at optimum cost.*
- /Web19/ Arbeitsblätter zur Vorlesung. Auslegung und Steuerung pneumatischer Antriebe. Prof. Dr.-Ing J. Weber. Dr.Ing. habil. A. Ulbricht. Auflage 2019
- /Win12/ Government of Winnipeg, Canada:  
[https://www.winnipeg.ca/finance/findata/matmgt/documents/2012/682-2012/682-2012\\_Appendix\\_HWSTP\\_South\\_End\\_Plant\\_Process\\_Selection\\_Report/Appendix%207.pdf](https://www.winnipeg.ca/finance/findata/matmgt/documents/2012/682-2012/682-2012_Appendix_HWSTP_South_End_Plant_Process_Selection_Report/Appendix%207.pdf)  
(requested on: 21.09.19)
- /Wolt11/ Wöltje, Jörg: Betriebswirtschaftliche Formelsammlung. Haufe, 2011
- /Xue17/ Xuefan, Dong & Lian, Ying & Liu, Yijun. (2017). Small and Multi-Peak Nonlinear Time Series Forecasting Using a Hybrid Back Propagation Neural Network. Information Sciences. 424. 10.1016/j.ins.2017.09.067.
- /Ye08/ Construction Management. Polytechnic University of Valencia. Pellicer, E.; Yepes, V.; Teixeira, J.M.C.; Moura, H.; Catalá, J. 2008
- /Zha14/ Overall Life Cycle Comprehensive Assessment of Pneumatic and Electric Actuator ZHANG Yeming and CAI Maolin. CHINESE JOURNAL OF MECHANICAL ENGINEERING Vol. 27, No. 3, 2014

---

## 9 Annex

### 9.1 Table of shipping costs

<b>Size</b>	<b>Dimensions</b>	<b>Weight</b>	<b>Delivery type</b>	<b>Shipping price</b>
XS	max. 35 x 25 x 10 cm	< 2 kg	Package	3,79 €
S	max. 60 x 30 x 15 cm	< 2 kg	Package	4,39 €
M	max. 120 x 60 x 60 cm	< 5 kg	Package	5,99 €
L	max. 120 x 60 x 60 cm	< 31,5 kg	Van	16,49 €
XL	max. 240 x 120 x 220 cm	< 1000 kg	Truck	490,26 €

**Declaration of authorship**

I hereby confirm with my signature that I have submitted the diploma thesis on the theme:

***Methodology development for the cost-benefit analysis of pneumatic and electromechanical drive structures***

completely independently and only using the literature and partners specified in the paper.

***Cristina Pascual Rico***

Signature with first name and surname

Dresden, 23.09.2019